

# Telephony Softswitch Solution (TSS) 4.0

## Training Programs

Package Presentation



### Name

---

Title

Ericsson Global Services

xxxxx.xxxx@ericsson.com

# Why invest in TSS 4.0 Package

- **Faster time to revenue**
- **Cost efficiency**
- **Increased performance/less churn**
- **Minimal risk**
- **Organizational effectiveness**

# What's in the TSS 4.0 Package?

## Target Audience & Competence Levels

**Network Operation**









**Surveillance**

**Configuration**

**Advanced Operation**

**Network Design Engineer**

# Supported Service Delivery Methods

<b>Icon</b>	<b>Delivery Method</b>
	Instructor Led Training (ILT)
	Seminar (SEM)
	Workshop (WS)
	Virtual Classroom Training (VCT)
	Web Based Learning (WBL)
	Short Article (SA)
	Streaming Video (SV)
	CD-ROM (CD)

# TSS 4.0

## - Delta Training -

# AXE 810 Delta Training (FAB 102 1310)

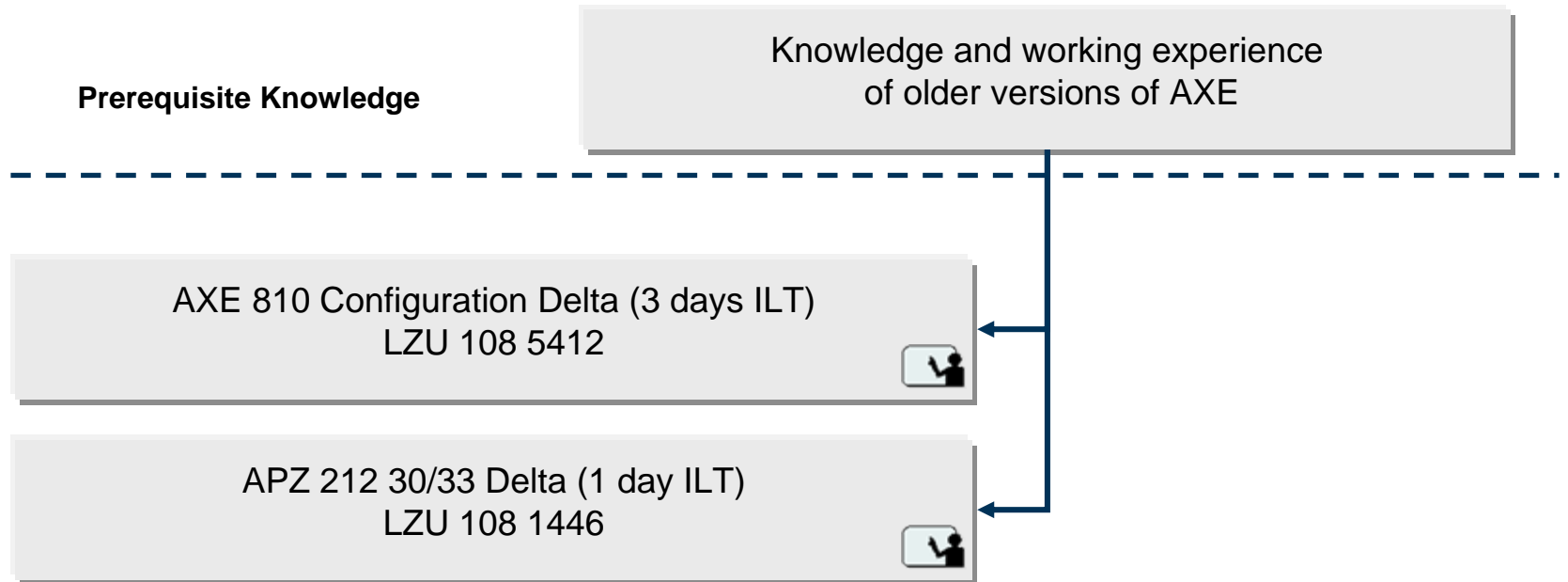

# APZ212 50 and APG40 Delta (FAB 102 1844 R2A)

**Prerequisite  
Knowledge**

Knowledge and experience in working with older versions of APZ and APG40

APZ 212 50 Operation Delta (2 days ILT)

LZU 108 6526 R1A



APG40 Delta (Windows 2003)  
(0,5 day ) LZU 108 6455 R2A



# AXE Enabler Network Configuration (FAB 102 1346)

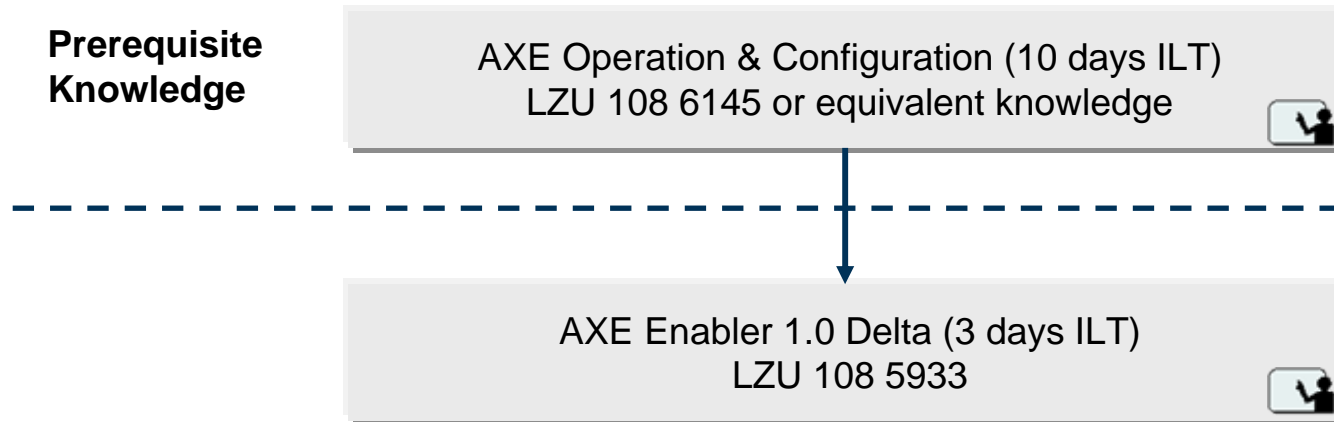

# ENGINE Integral 3.1 to TSS 4.0 Delta Training (FAB 102 1885)

**Prerequisite Knowledge**

Knowledge and working experience with the ENGINE Integral 3.1 Network

ENGINE Integral 3.1 to TSS 4.0 Integr&Verif Delta (3 days **ILT**)  
LZU 108 6629



# MN-OSS Delta Training for TSS (FAB 102 1889 R2A)

**Prerequisite  
Knowledge**

Knowledge and working experience with the MN-OSS R6



MN-OSS R6 to R8 Delta for TSS  
(1 day **ILT**)  
LZU 108 6630



# TSS 4.0

## - Network Fundamentals -

# Introduction to IP Networks, WBL (FAB 102 1313)

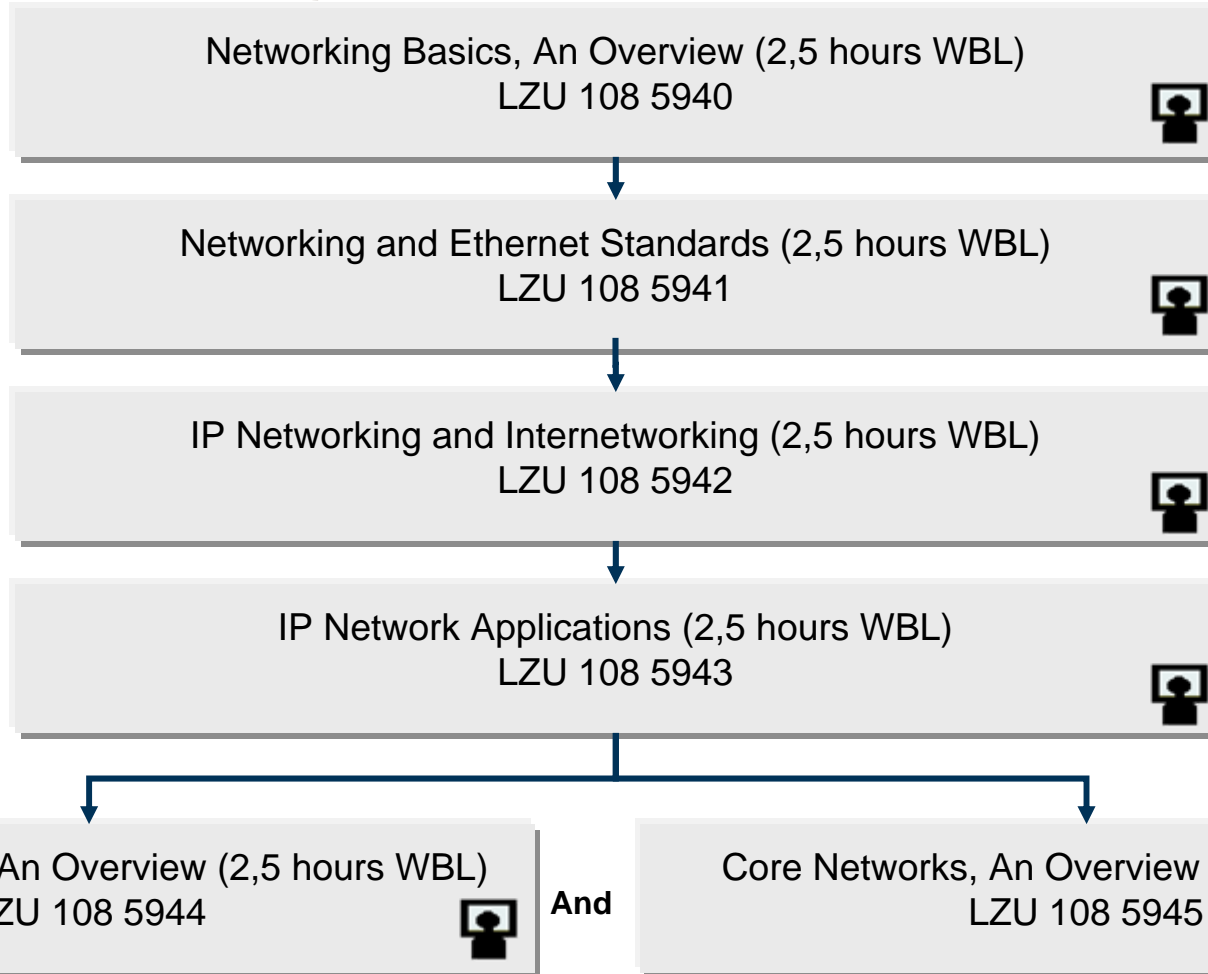

# IP Fundamentals (FAB 102 1314 R2A)

**Prerequisite  
Knowledge**

Introduction to IP Networks, WBL  
FAB 102 1313



IP Networking (5 days ILT)  
LZU 102 397



IP Advanced (5 days ILT)  
LZU 108 6748



# Ericsson Access Ramp (EAR) Fundamentals (FAB 102 1749)

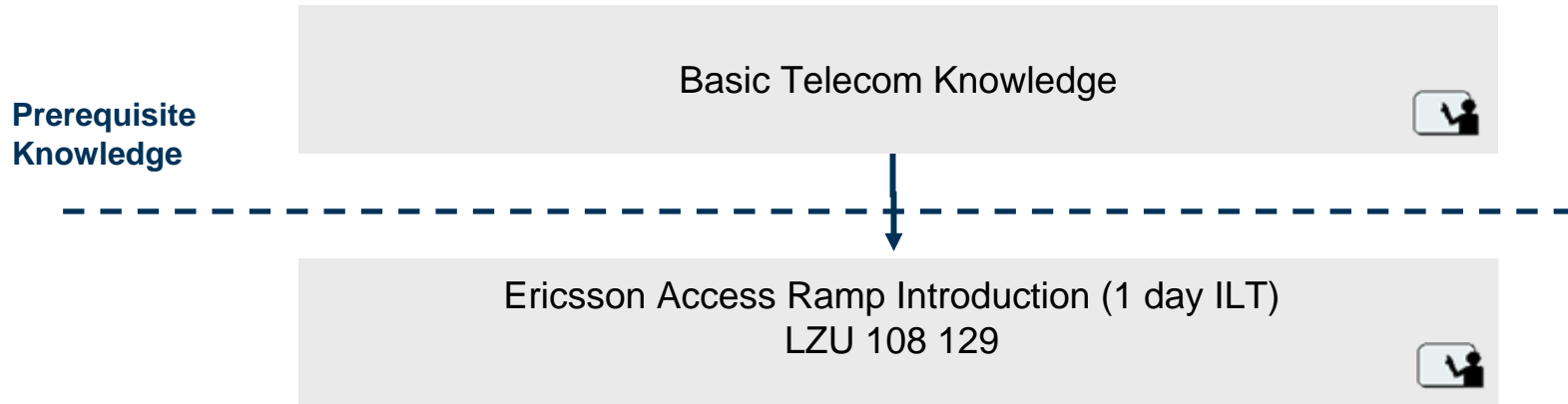

# Access Ramp Gateway (ARG) Fundamentals (FAB 102 1958)

**Prerequisite  
Knowledge**

Basic Telecom Knowledge



Access Ramp Gateway Introduction (1 day ILT)  
LZU 108 6751



# AXE Fundamentals (FAB 102 1336)

**Prerequisite Knowledge**

Basic Telecom Knowledge



AXE Survey (3 days ILT)  
LZU 108 775



# Integrated Site (IS) Fundamentals (FAB 102 1895)

**Prerequisite  
Knowledge**

IP Fundamentals  
FAB 102 1314

Integrated Site Overview (1 day ILT)  
LZU 108 6364



# TSS Fundamentals

## (FAB 102 1892)

**Prerequisite Knowledge**

Basic Telecom Knowledge



TSS Introduction (1 day ILT)  
LZU 108 6637



# TSS 4.0

## - Network Management -

# MN-OSS Operation for TSS, Network Surveillance (FAB 102 1890 )

## Prerequisite Knowledge

AXE Operation and Configuration  
LZU 108 6145

Or

AXD 301/305 8.0 Configuration and Verification  
LZU 108 6636

MN-OSS Operation for TSS (5 days ILT)  
LZU 108 6631



MN-OSS Operation for AXE (3 days ILT)  
LZU 108 6632



Ericsson Analyzer Workshop (3-5 days ILT)  
LZU 108 6529



# MN-OSS System Administration for TSS (FAB 102 1891 )

## Prerequisite Knowledge

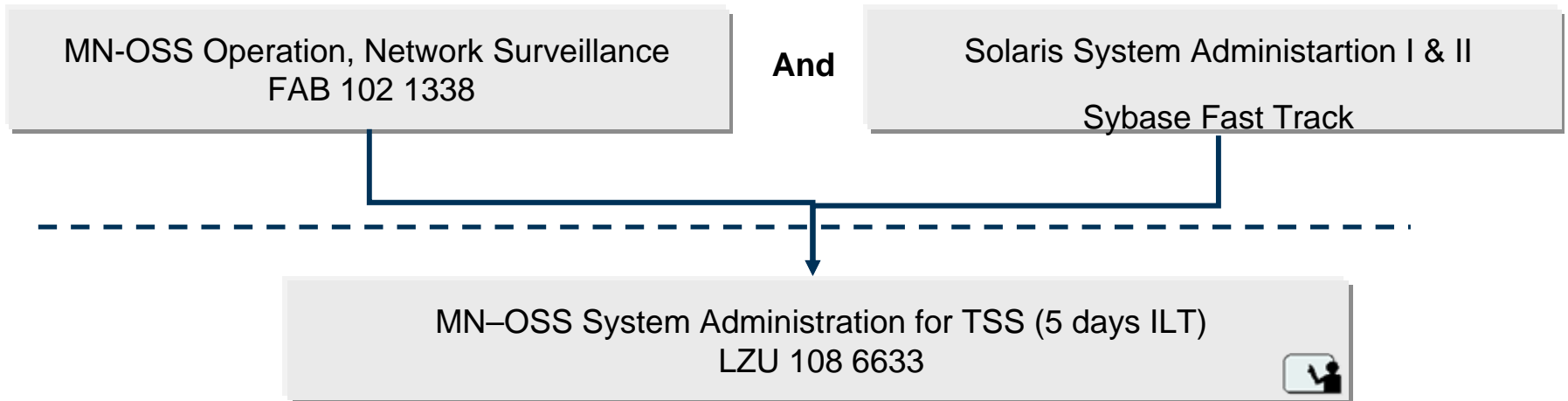

# TSS 4.0

## - Field Maintenance -

# AXD 301/305 Field Maintenance (FAB 102 1887)

**Prerequisite  
Knowledge**

IP Fundamentals  
FAB 102 1314

AXD 301 Maintenance (1 day ILT)  
LZU 108 6635



# AXE Field Maintenance (FAB 102 1365)

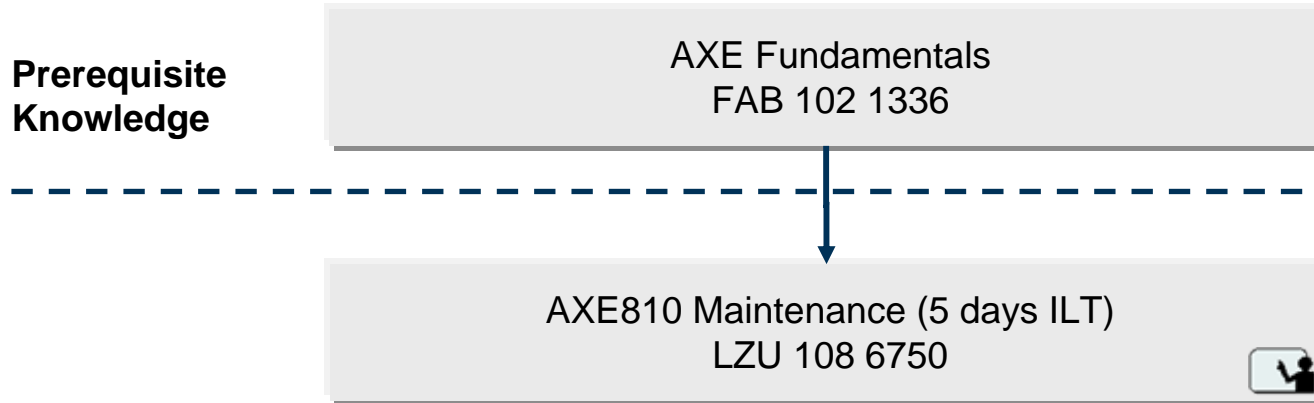

# TSS 4.0

## - Network Operation -

# AXD 301/305 Network Operation & Configuration (FAB 102 1888)

**Prerequisite  
Knowledge**

IP Fundamentals  
FAB 102 1314

AXD 301 7.5 Configuration & Verification (3 days ILT)  
LZU 108 6636



# Integrated Site (IS) Network Configuration (FAB 102 1896)

**Prerequisite Knowledge**

Integrated Site Fundamentals  
FAB 102 1895

Integrated Site Operation & Configuration (3 days ILT)  
LZU 108 6832

IP Network Configuration for Integrated Site (2 days ILT)  
LZU 108 6669

# Integrated Site (IS) MGw 1.2 Operation and Configuration (FAB 102 2179)

**Prerequisite Knowledge**

Integrated Site Fundamentals  
FAB 102 1895

IS MGw 1.2 Operation & Configuration (2 days ILT)  
LZU 108 7013



# AXE Network Operation & Configuration (FAB 102 1344)

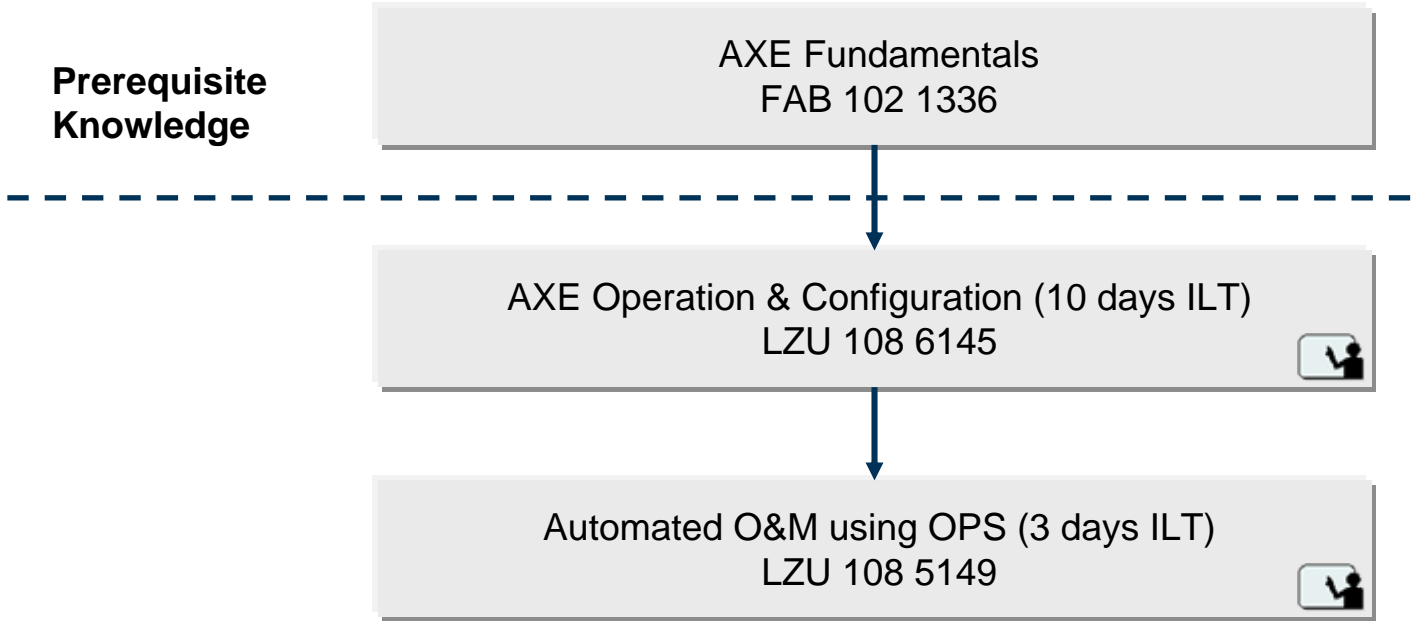

# APG 40 (NT4) Node Operation & Configuration (FAB 102 1345)

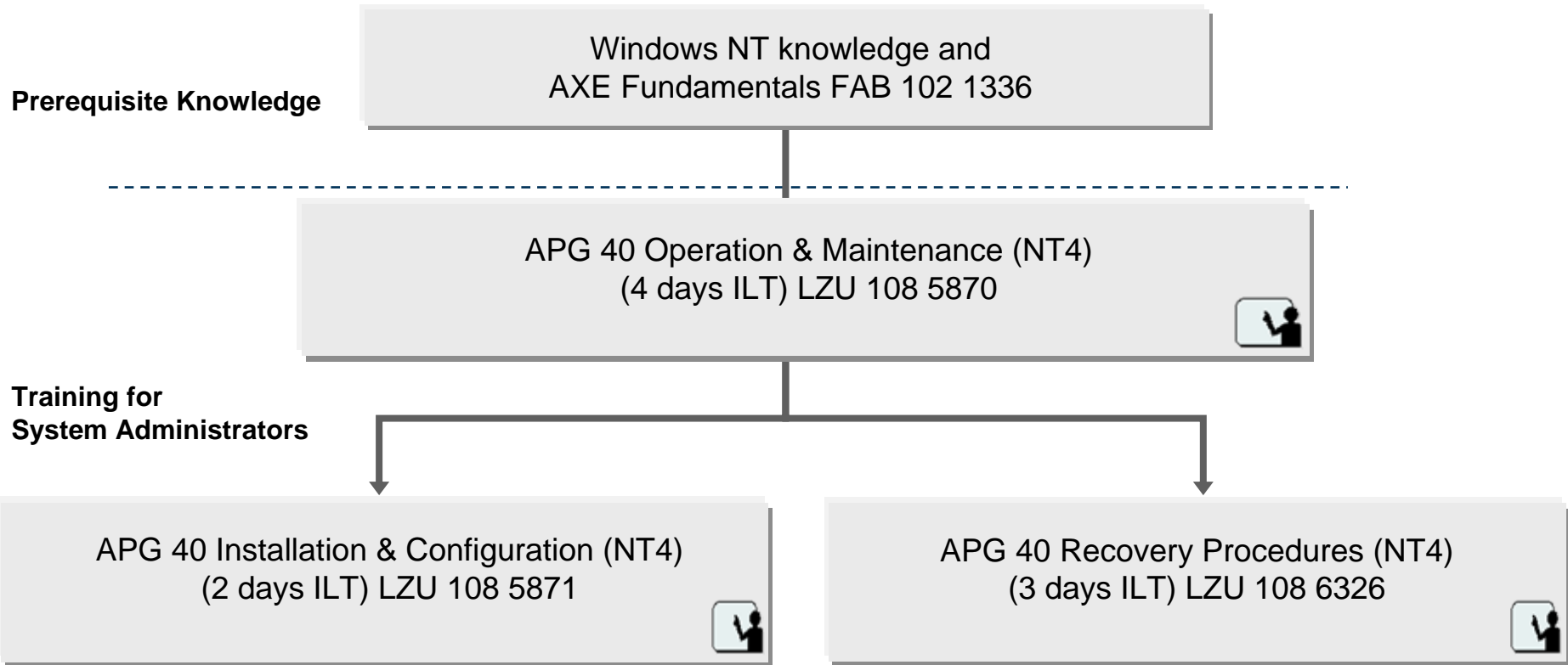

# APG 40 (Windows 2003 C2) Node Operation & Configuration (FAB 102 1847)

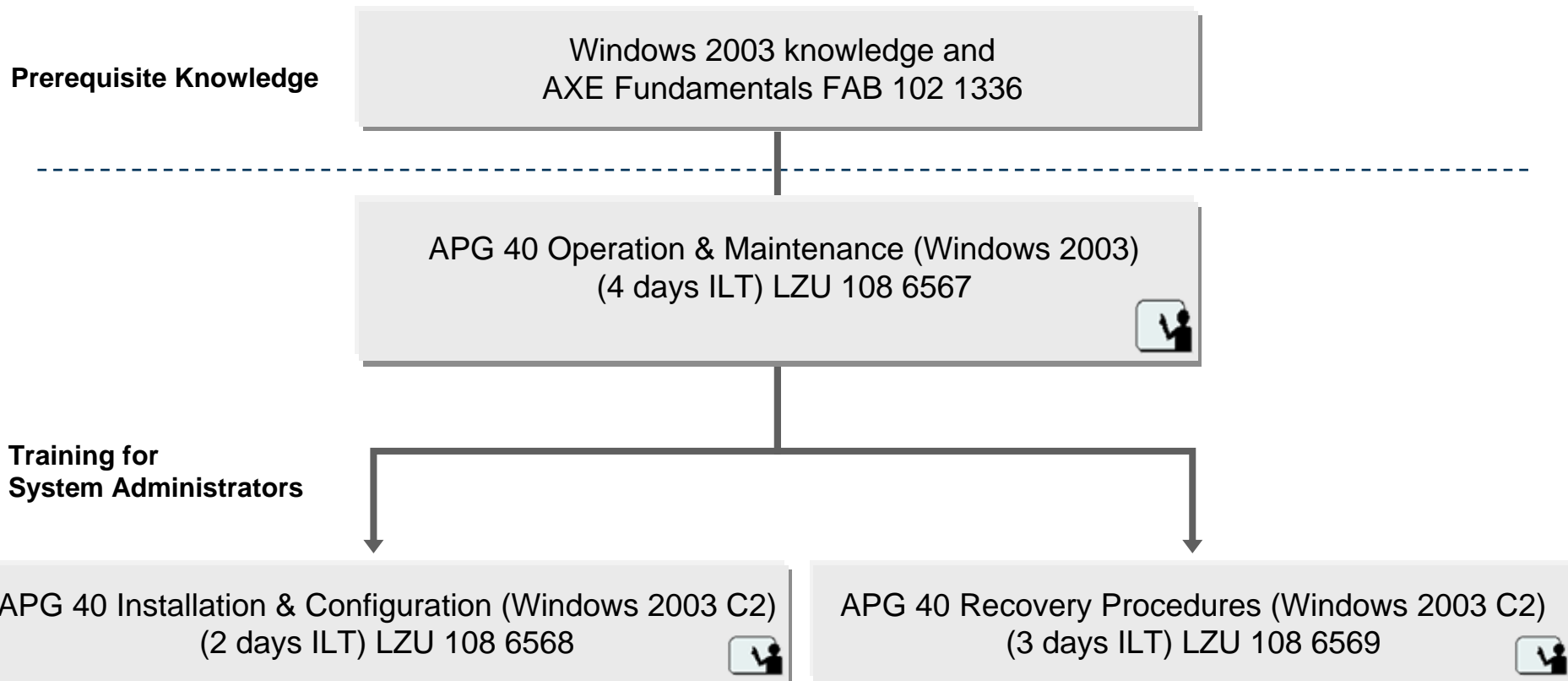

# APG 40 (Windows 2003 C4) Node Operation & Configuration (FAB 102 1911)

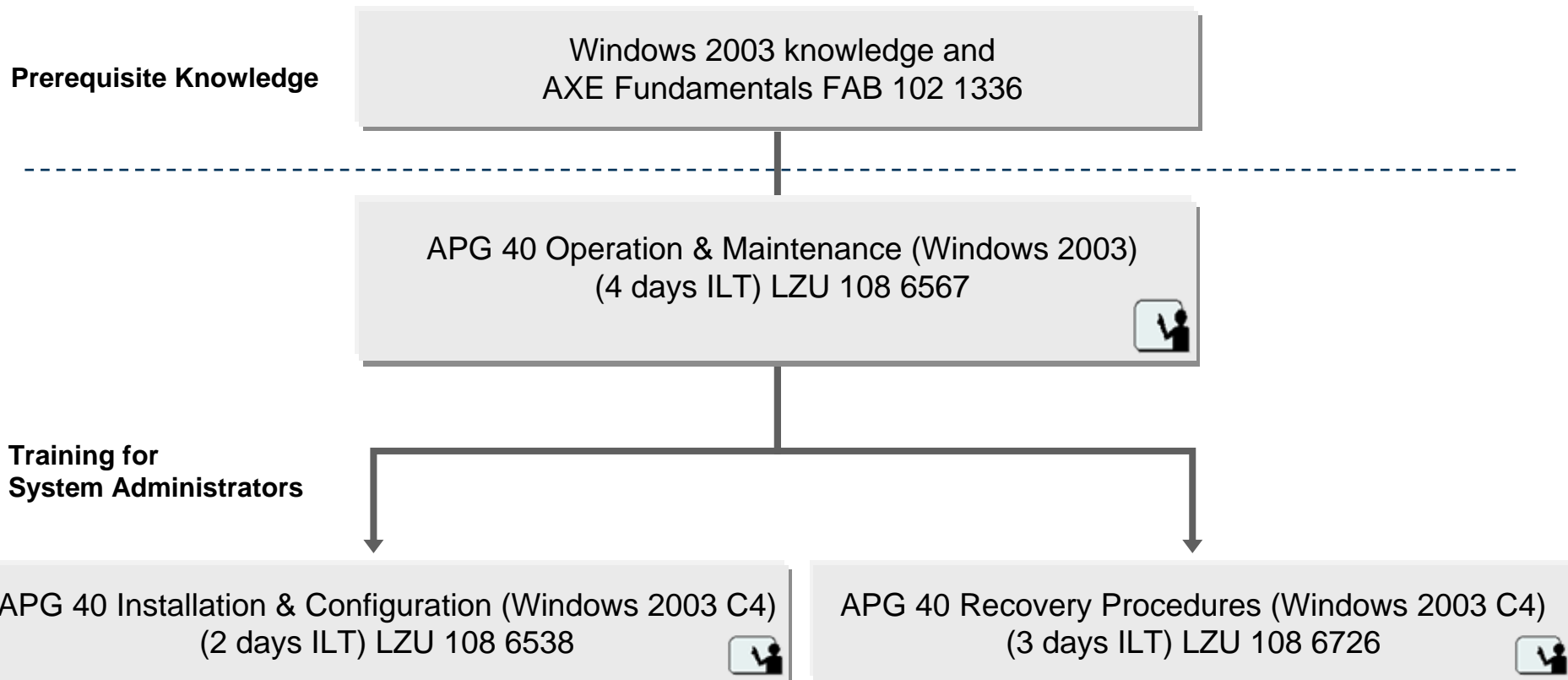

# Ericsson Access Ramp (EAR) Network Configuration (FAB 102 1750)

**Prerequisite Knowledge**

AXE Network Operation & Configuration FAB 102 1344



EAR Operation & Maintenance for AXE Application  
(3 days ILT)  
LZU 108 5057



# Access Ramp Gateway (ARG) Network Configuration (FAB 102 1959)

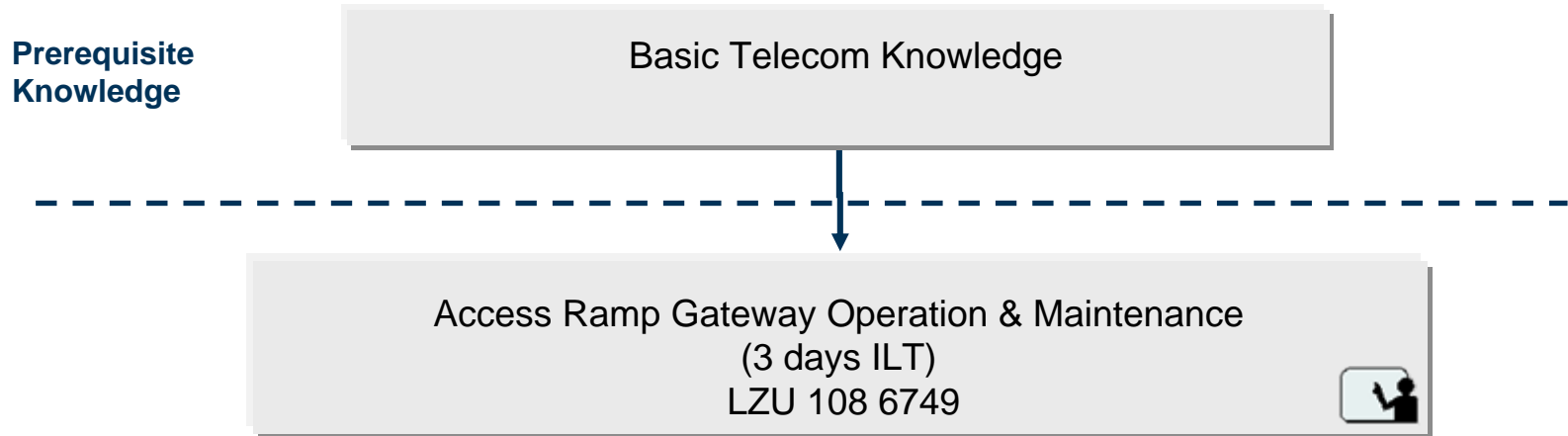

# TSS Signaling Network Configuration (FAB 102 1894)

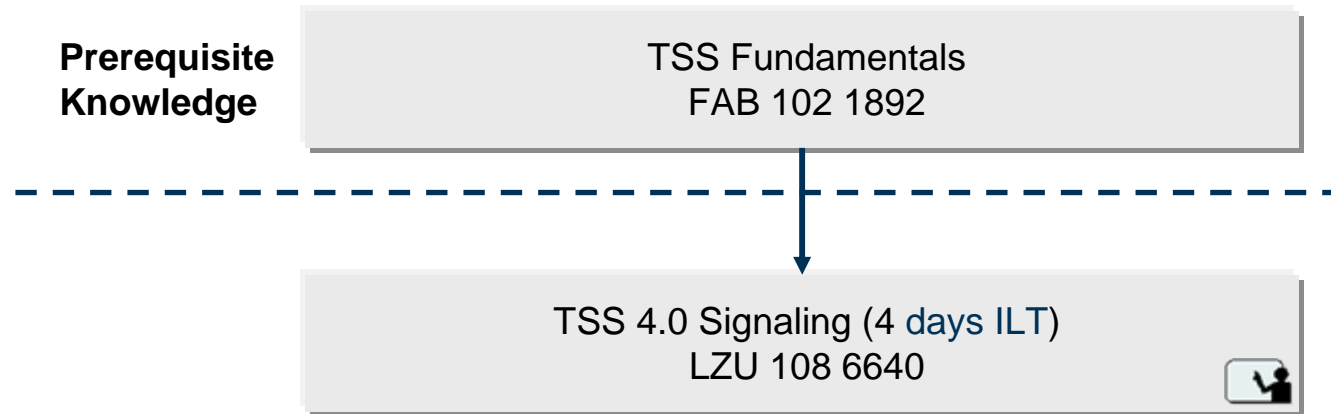

# TSS 4.0 Network Configuration (FAB 102 1893)

## Prerequisite Knowledge

TSS Fundamentals, FAB102 1892  
AXE Network Operation & Configuration, FAB 102 1344  
and  
AXD 301/305 Network Operation & Configuration, FAB 102 1888  
or  
Integrated Site Fundamentals FAB1021895 and Integrated Site Network  
Configuration FAB102 1896  
and  
Access Ramp Gateway Network Configuration FAB 102 1959 (optional)

TSS 4.0 Integration & Verification (5 days ILT)  
LZU 108 6638

AXE 810 Data Transcript (5 days ILT)  
LZU 108 6134

TSS 4.0 Fault Finding (2 days ILT)  
LZU 108 6639

# TSS Dimensioning (FAB 102 1903)

**Prerequisite  
Knowledge**

TSS Fundamentals FAB 102 1892



TSS Dimensioning (3 days ILT)  
LZU 108 6668



# How do we deliver?

- ILT courses, delivered at Ericsson training centres or at customers site.
- e-learning products delivered by either Internet solution or Education Online portal on the extranet towards external customers.



# Why Ericsson Education?

- **Global strength local expertise**
  - One of the worlds largest competence solutions suppliers
- **Broad Global Service Product Portfolio**
- **Blended learning solutions**
  - Instructor Led Training (ILT)
  - On-the-job programs
  - Web based learning (WBL)
  - Streaming Videos (SV)
  - Seminars
  - Multi-media based learning (MBL)
  - Virtual Classroom (VCT)/ Remote Training
  - Online Articles
  - On the Job Training
  - Workshop



## Cover all competence areas

- Technical/Professional, Business and Human skills

# Summary

## Be empowered

**Ericsson Education is your competence partner. Linking human performance to business outcomes will give you the power to succeed. Our solutions combine global strength with local expertise - increase your performance anytime, anywhere.**

**With us, you will be first choice.**



# Global reach, at a local level!

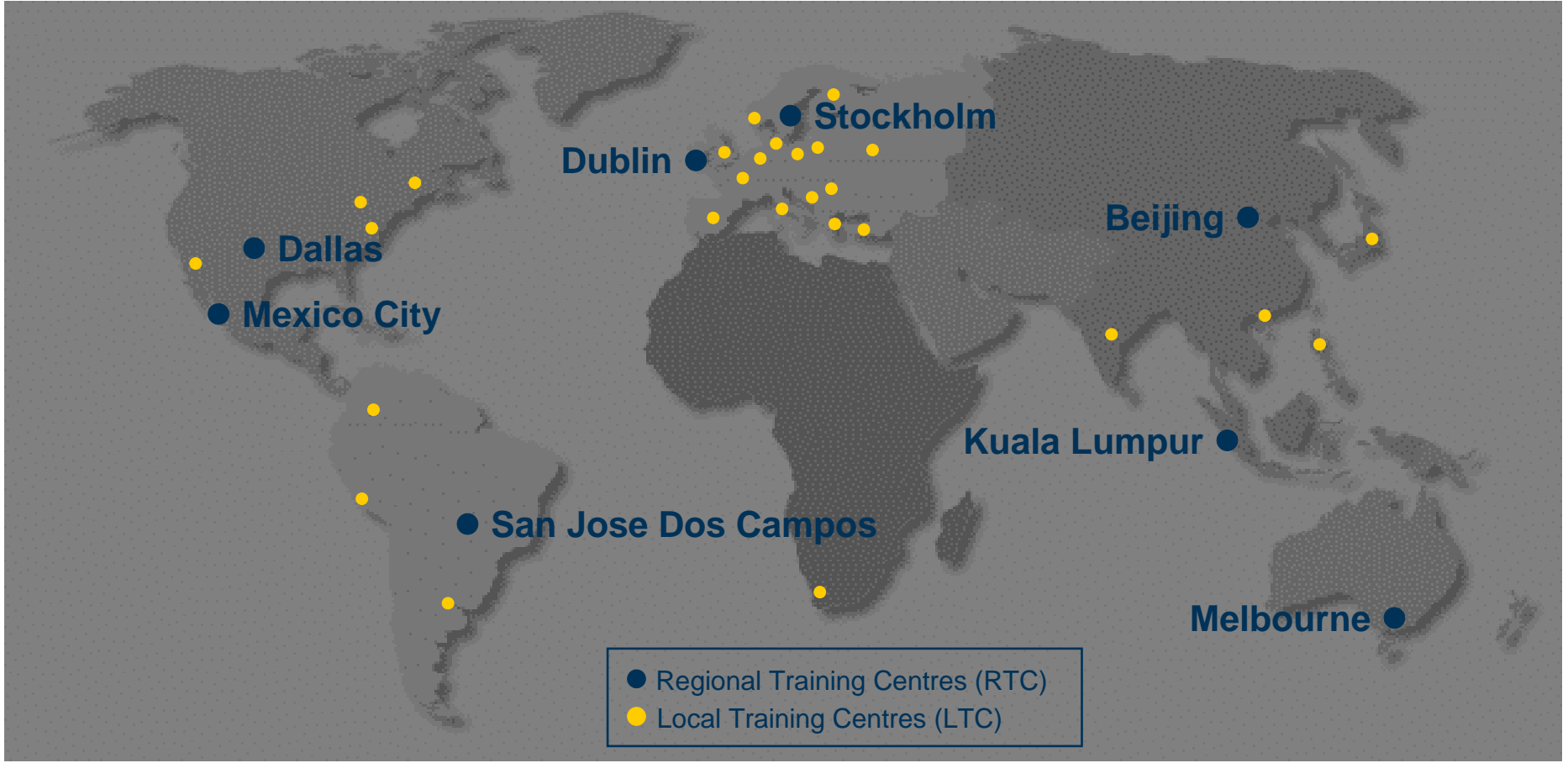

**ERICSSON** 

**TAKING YOU FORWARD**