

# **GSM R10 Core Network**

## **Training Programs**

**Package Presentation**



## Why invest in GSM R10 Core Network Package









- **The package is divided into modular flows for each work area and node or platform in the GSM Core Network. Combinations of these flows exactly match the job functions at the operator.**
- **The modularity of the portfolio ensures the shortest time for competence built-up of each target group**
- **The training flows are valid for personnel coming newly into the area of GSM as well as for experienced personnel in need of the “Delta” information for the new release or new functionality.**
- **The training flows provide a career model from basic to very advanced and specialized competence.**

# What's in the GSM R10 Core Network Package?

## Target Audience & Competence Levels

<p><b>Delta Training</b></p>	<p><b>Fundamentals</b></p>		
<p><b>Field Maintenance</b> Core Network Field Maintenance (up to advanced level for MSC)</p>	<p><b>Network Operation and Configuration</b> Network Surveillance Operation Configuration Advanced Operation (OSS-RC) Advanced Configuration (Signaling and Data Transcript) Integration</p>	<p><b>Network Development</b> Core Network Design Core Network Statistics</p>	<p><b>IS/IT Support</b> Application Operation (OSS-RC) System Administration (OSS-RC)</p>

# Supported Service Delivery Methods

Icon	Delivery Method
	Instructor Led Training (ILT)
	Seminar (SEM)
	Workshop (WS)
	Virtual Classroom Training (VCT)
	Web Based Learning (WBL)
	Short Article (SA)
	Streaming Video (SV)
	CD-ROM (CD)

# **GSM Core Network**

## **- Delta Training -**

## AXE 810 Delta Training (FAB 102 1310)

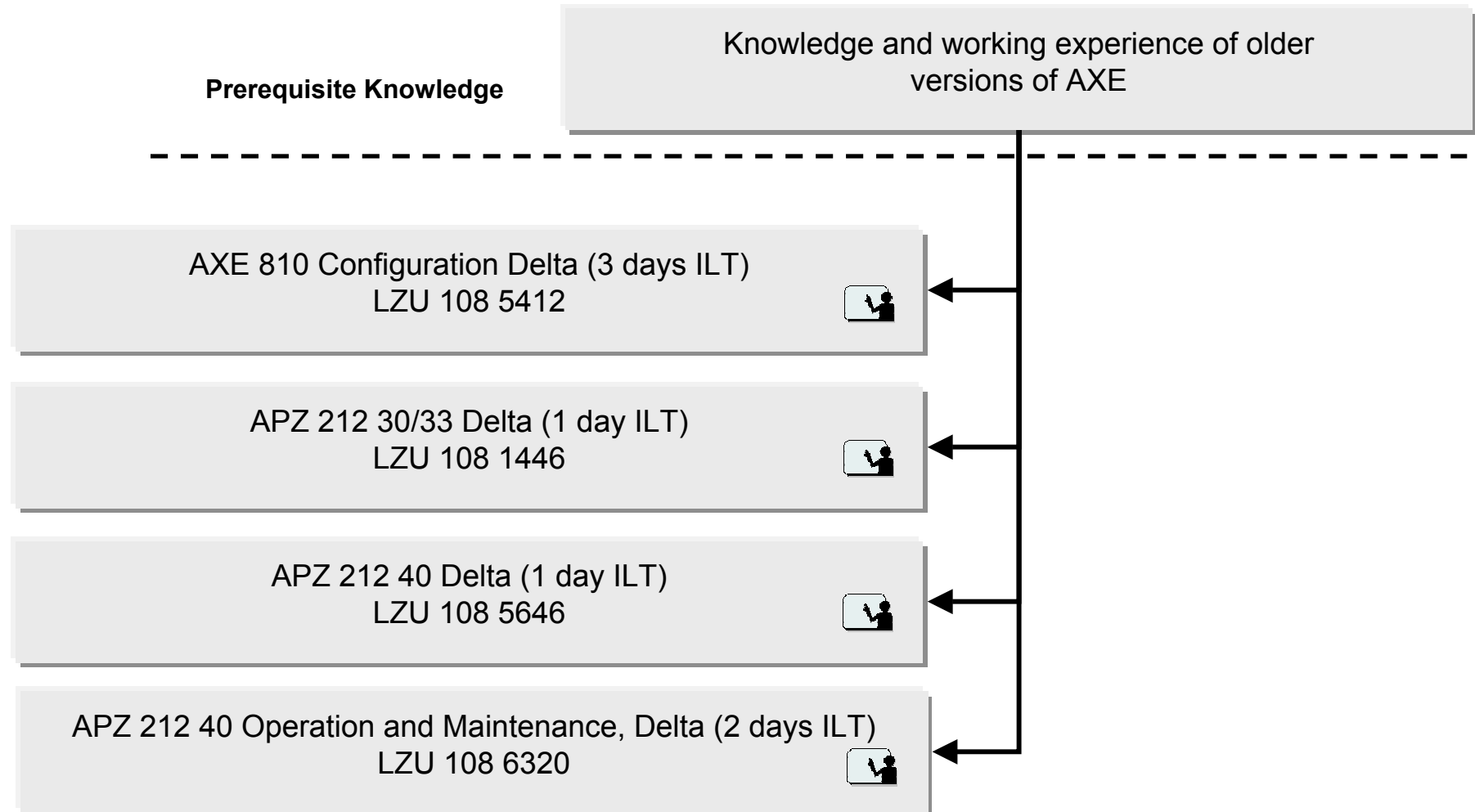

## GSM R10 Core Network Delta Training (FAB 102 1667)

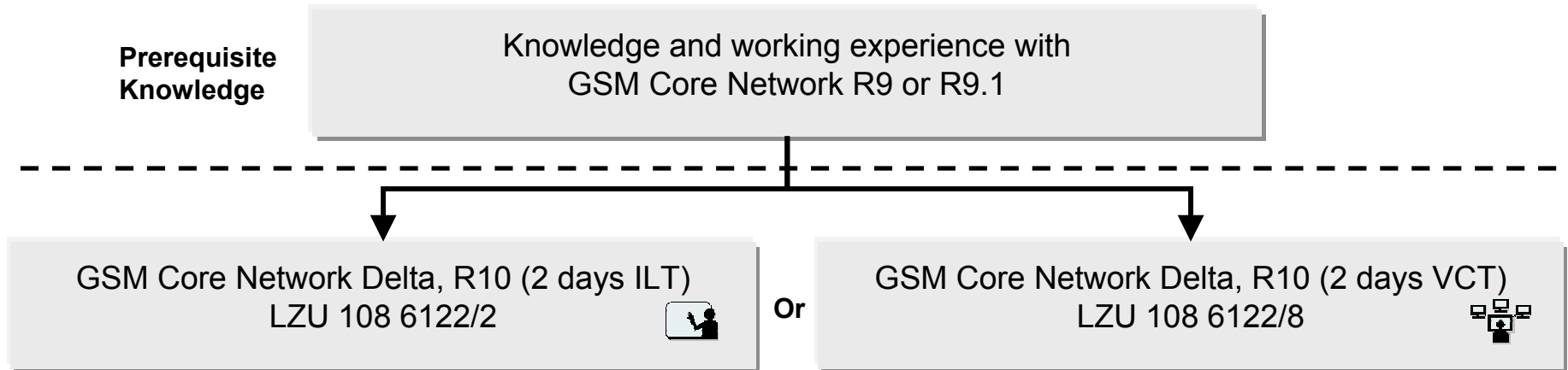

This course consists of modules for the different nodes involved in the Core Network. These modules could be extracted and instructed stand-alone. A dedicated module on SGSN5.5 is included here.

## GPRS Delta Training (FAB 102 1432)

**Prerequisite  
Knowledge**

Knowledge and working experience of older versions of GSN

GSM SGSN 5.0 Delta, Hands-On (2 days ILT)  
LZU 108 6192



In addition to this course, a dedicated module on SGSN5.5 is included in the course GSM Core Network Delta, R10, LZU 108 6122.

## OSS RC 1.1 Delta Training (FAB 102 1378)

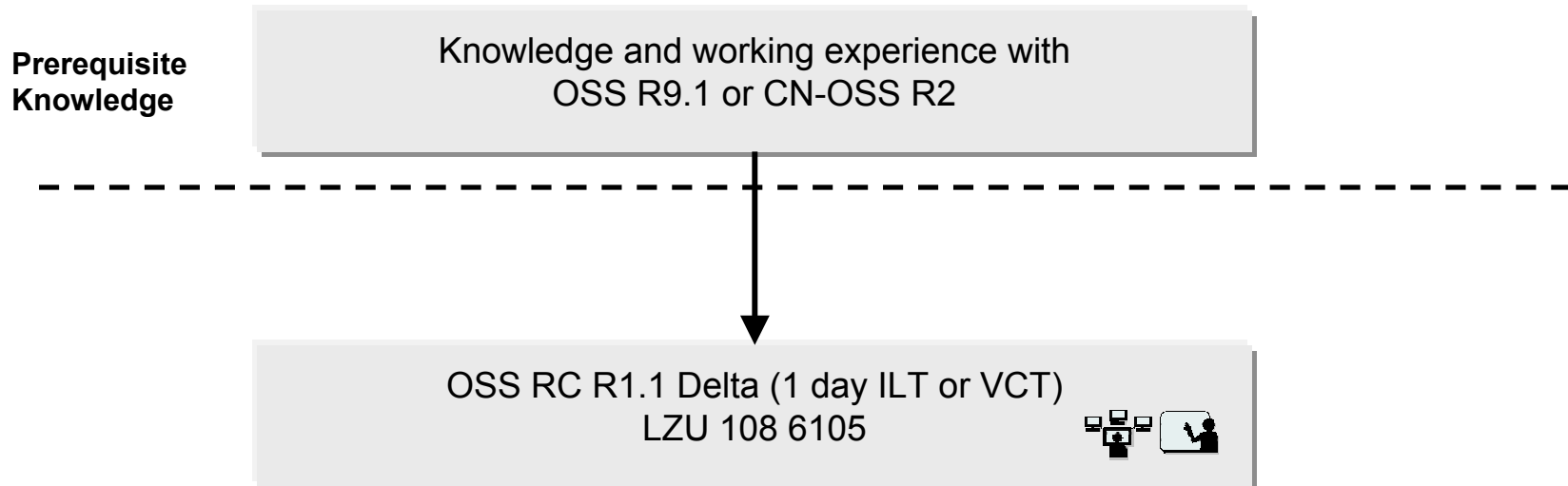

# GSM Network

## - Fundamentals -

## Introduction to IP Networks, WBL (FAB 102 1313)

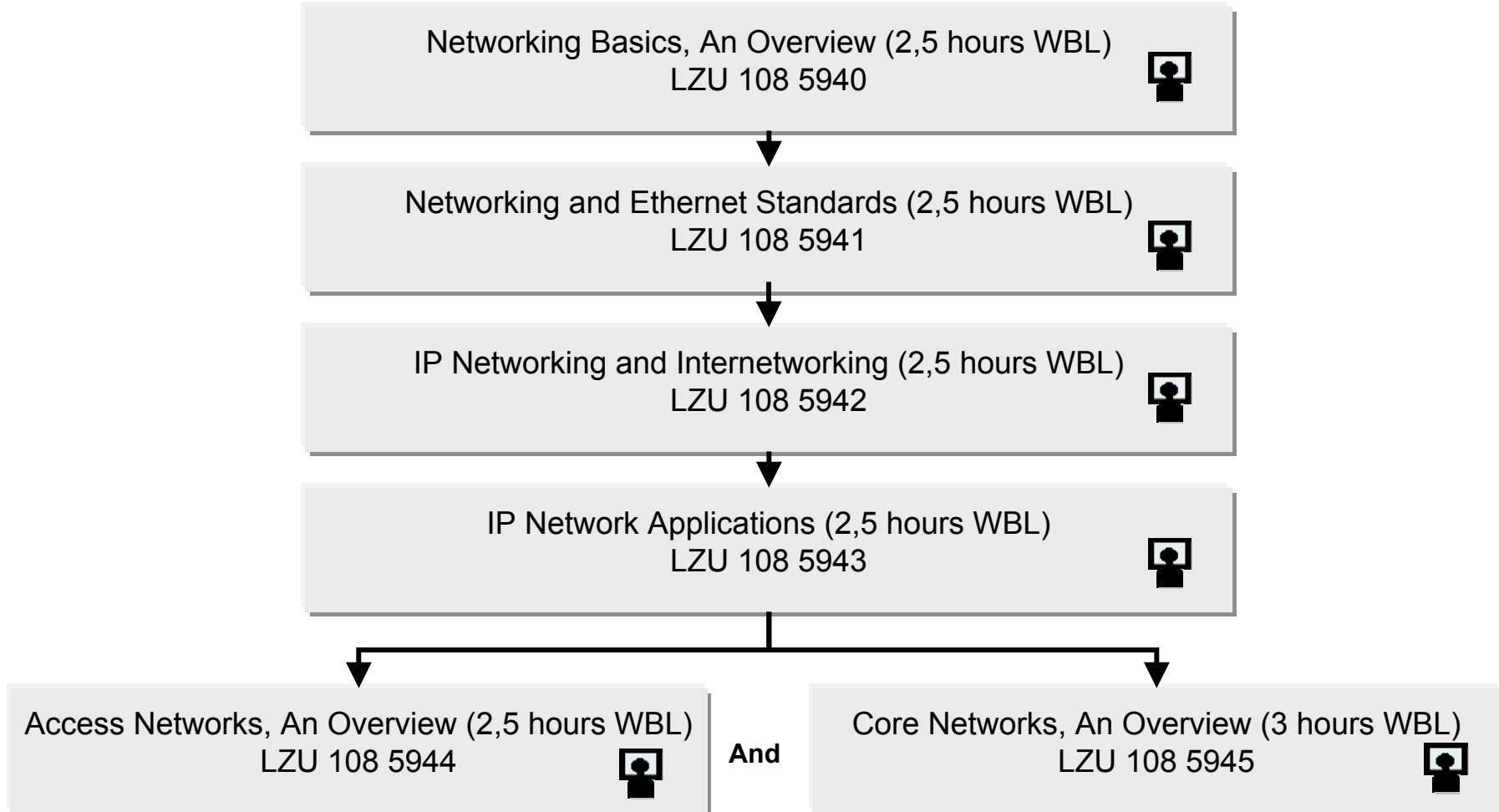

## IP Fundamentals (FAB 102 1314)

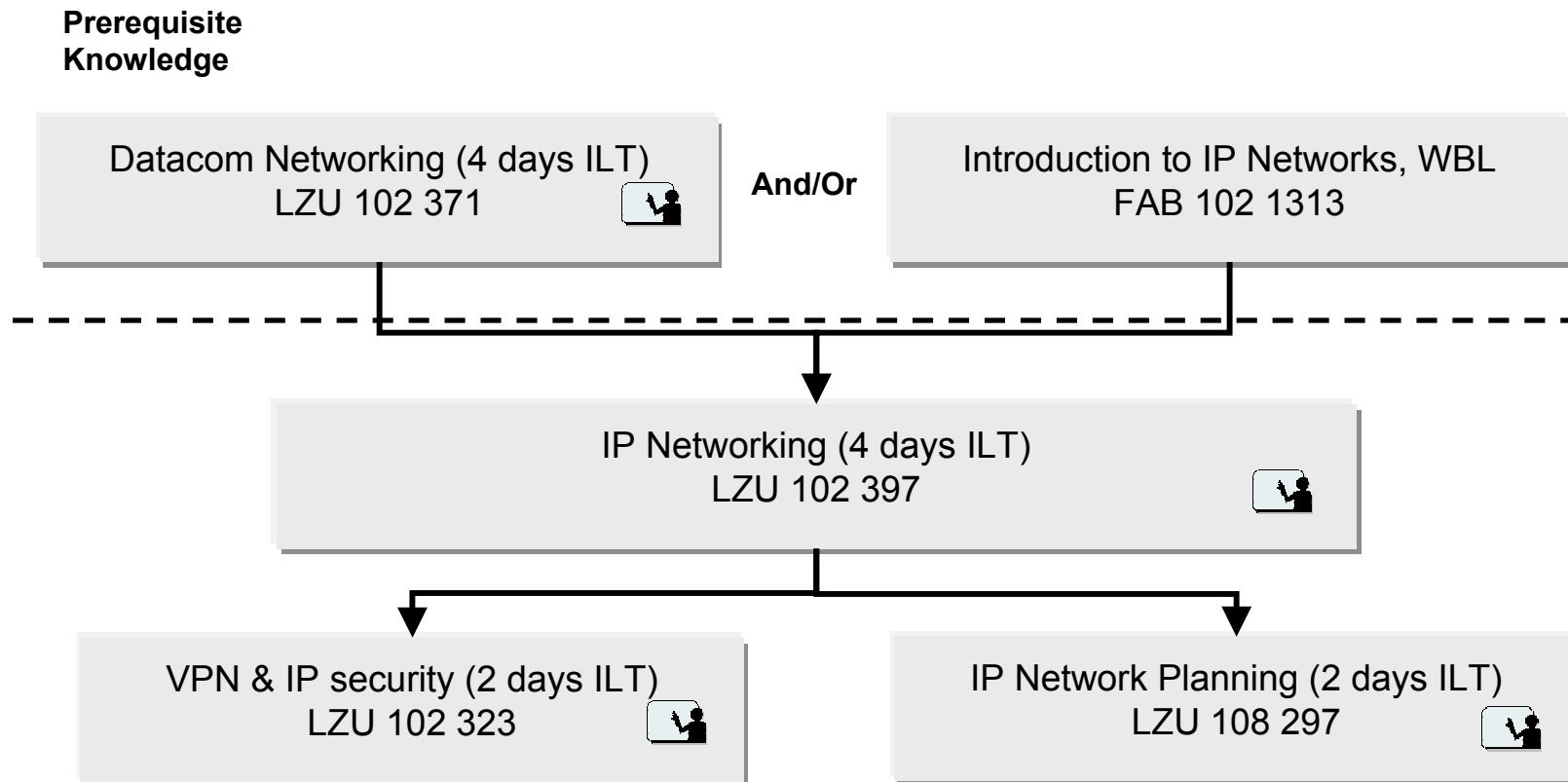

## IPv6 Fundamentals (FAB 102 1383)

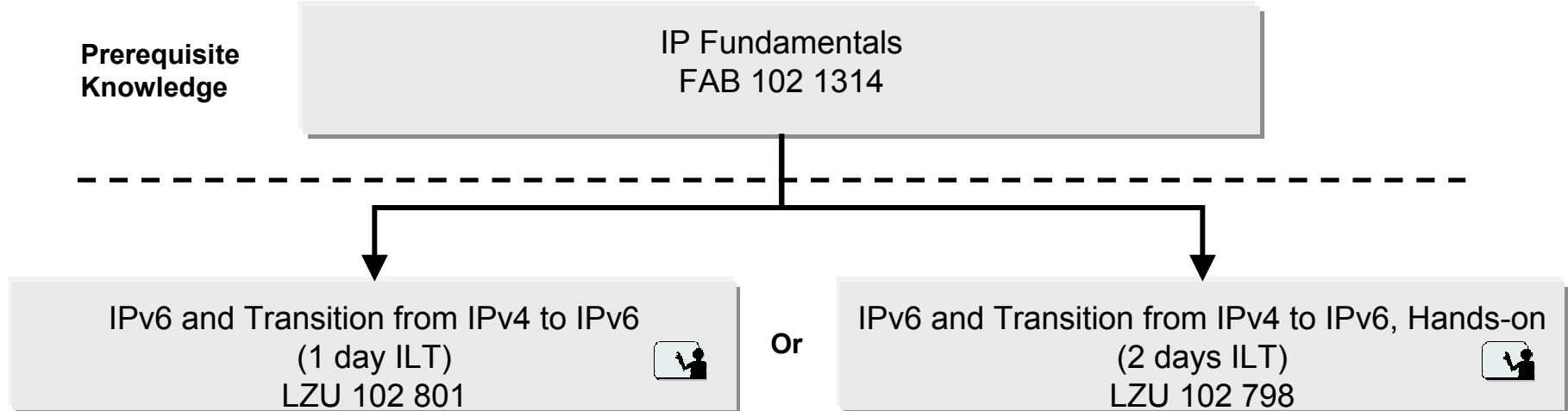

## IPv6 Routing Configuration (FAB 102 1384)

Prerequisite  
Knowledge

IPv6 Fundamentals  
FAB 102 1383



IPv6 Routing Protocols (2 days ILT)  
LZU 102 796



## IPv6 Advanced Network Configuration (FAB 102 1385)

Prerequisite  
Knowledge

IP Fundamentals  
FAB 102 1314

IPv6 Advanced Features (4 days ILT)  
LZU 102 797



## ATM Fundamentals (FAB 102 1315)

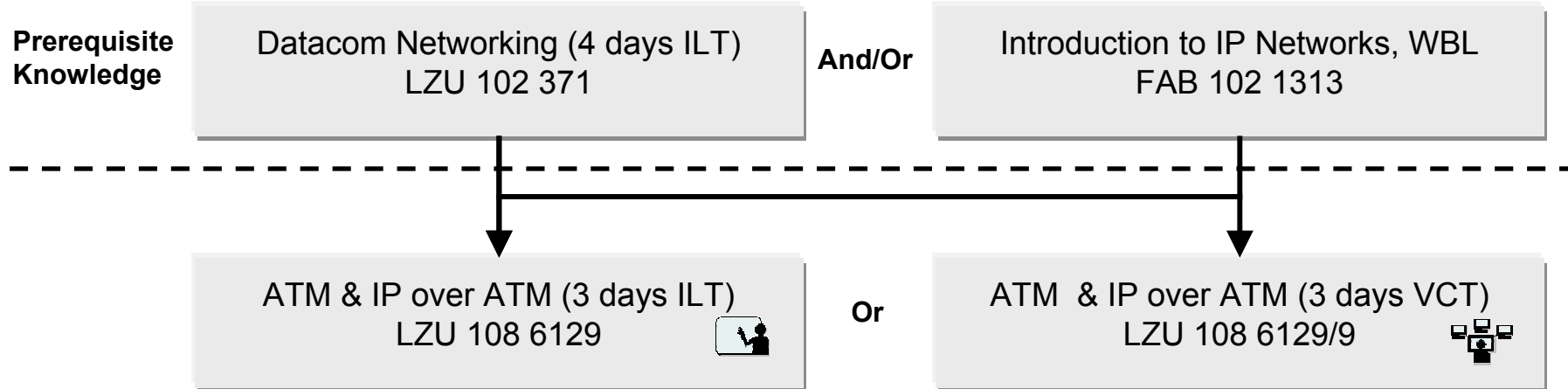

## GSM Network Fundamentals, Blended Training (FAB 102 1465)

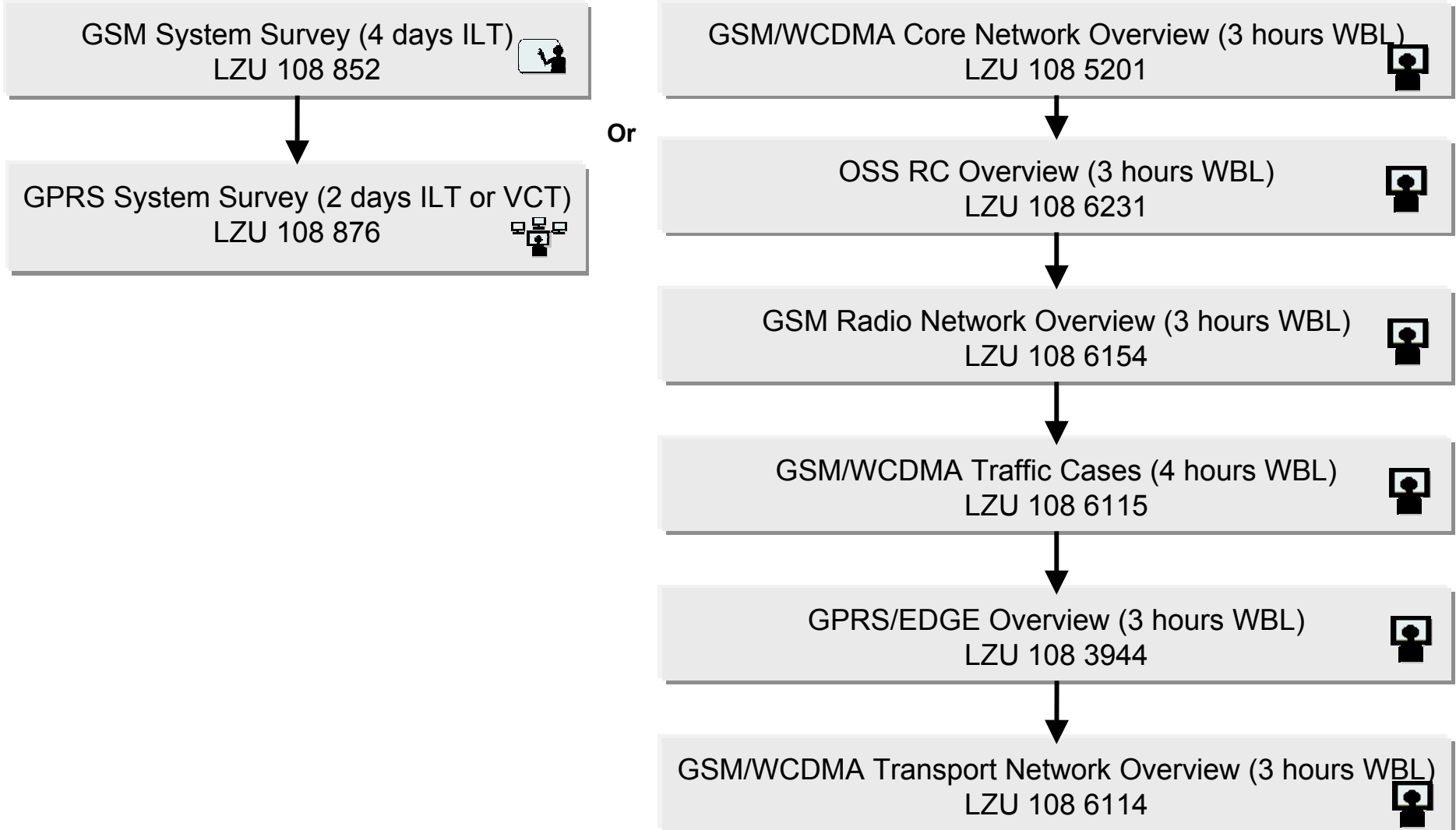

# GSM Core Network

## - Field Maintenance -

## GSM Core Network Maintenance (FAB 102 1466)

### Prerequisite Knowledge

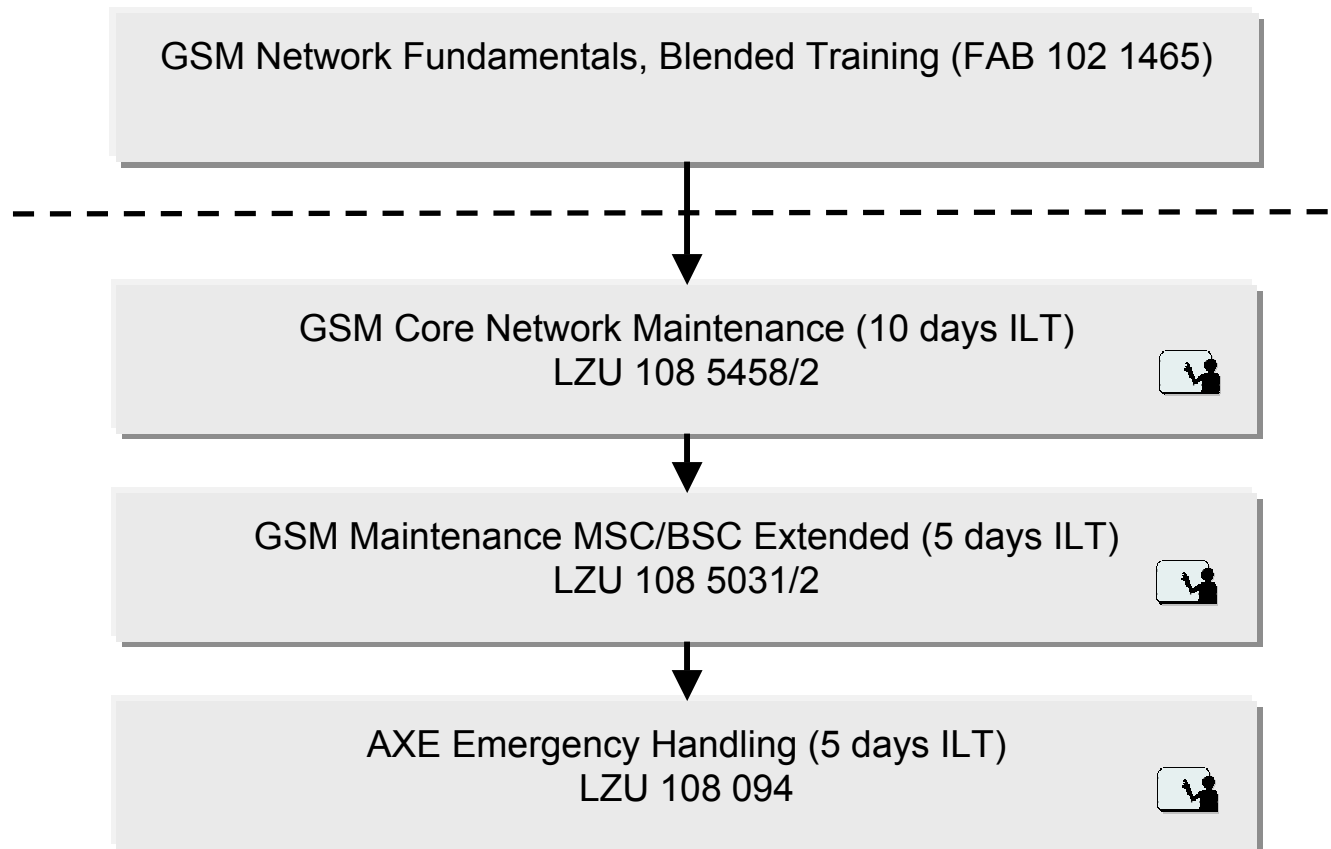

# GSM Core Network

## - Network Operation and Configuration -

## GSM Network Surveillance (FAB 102 1467)

### Prerequisite Knowledge

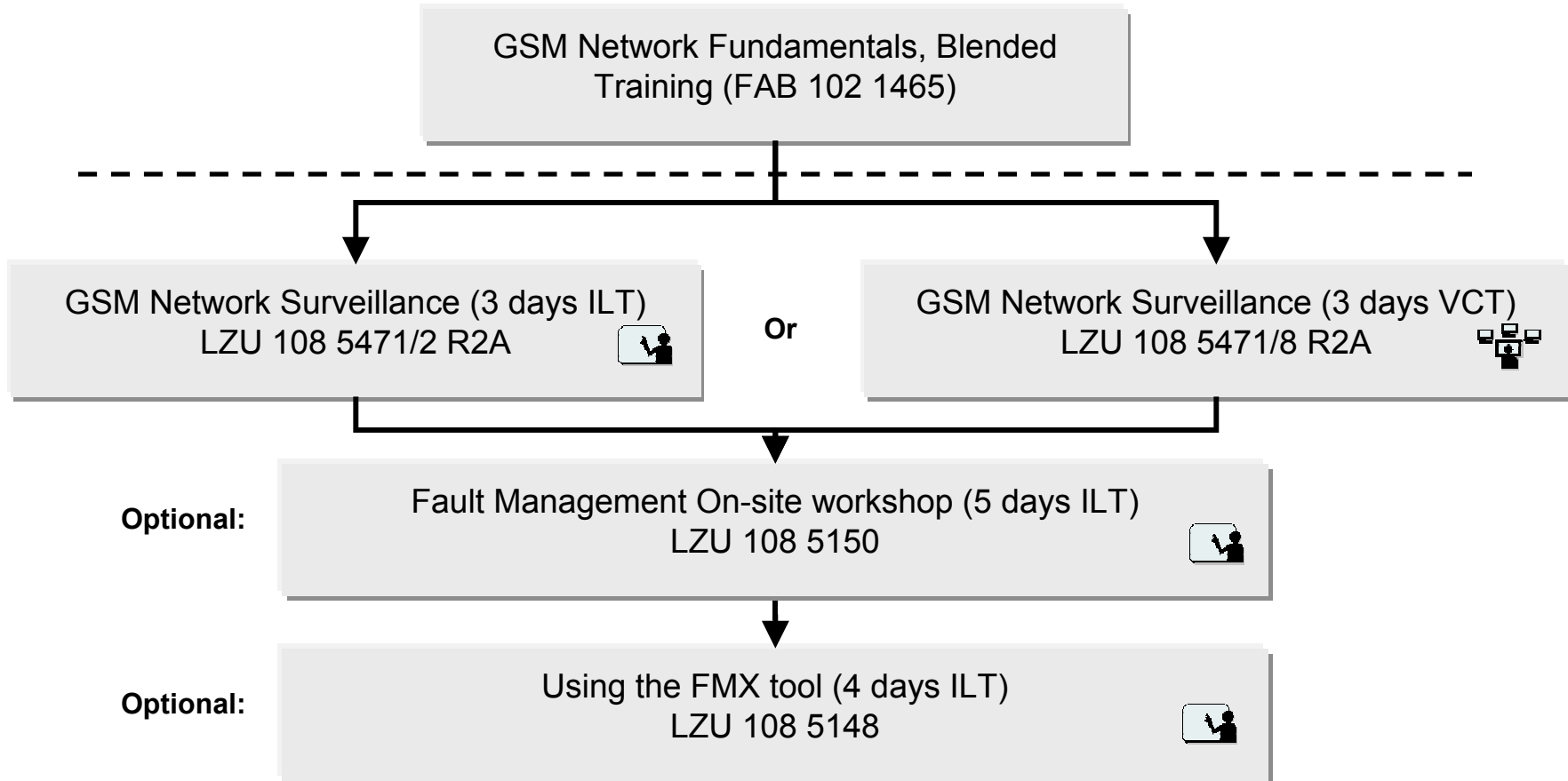

## APG 40 Network Operation & Configuration (FAB 102 1345)

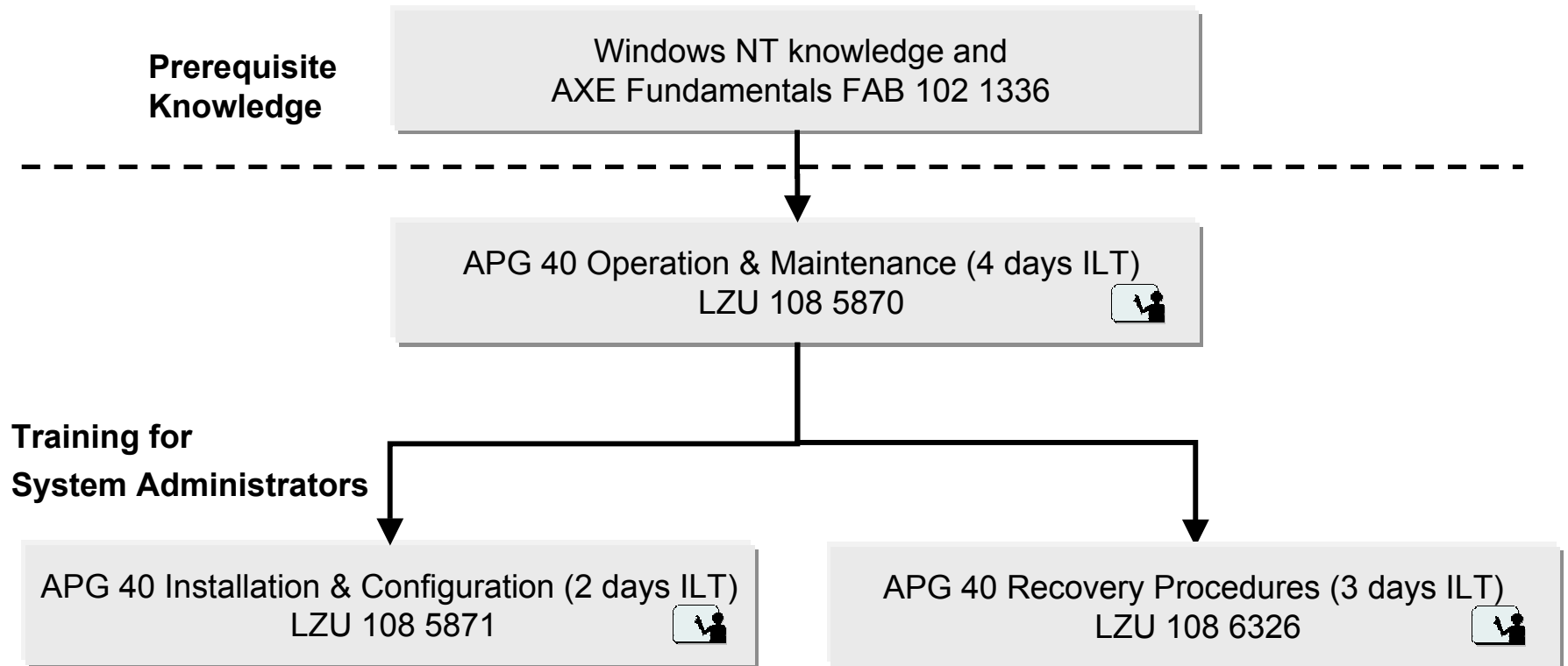

## GSM MSC/VLR Operation & Configuration (FAB 102 1468)

### Prerequisite Knowledge

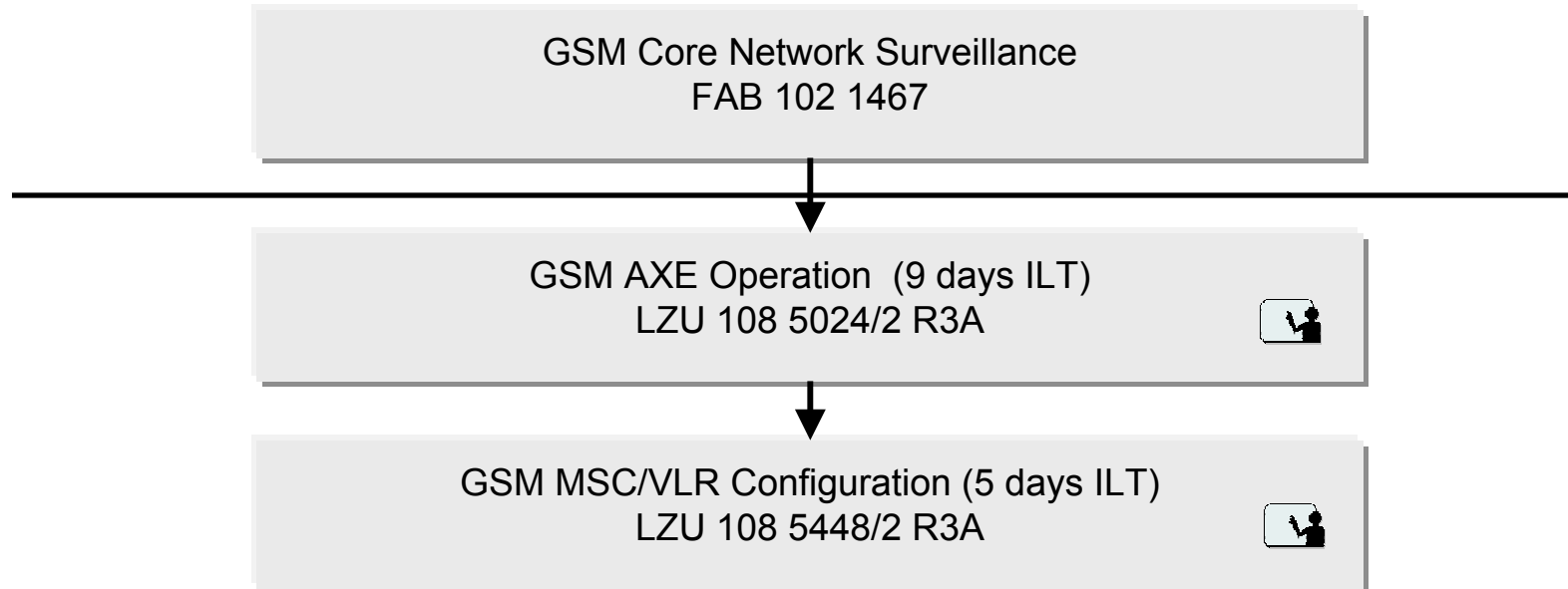

**Note:** Ericsson Education offers completing the competence development of the operator in the area of operating a GSM MSC by delivering a Structured Knowledge Transfer (SKT) Service on-site. For more information on SKT please refer to

<http://www.ericsson.com/products/services/training/skt.shtml>

## GSM User Database & Authentication Operation (FAB 102 1469)

### Prerequisite Knowledge

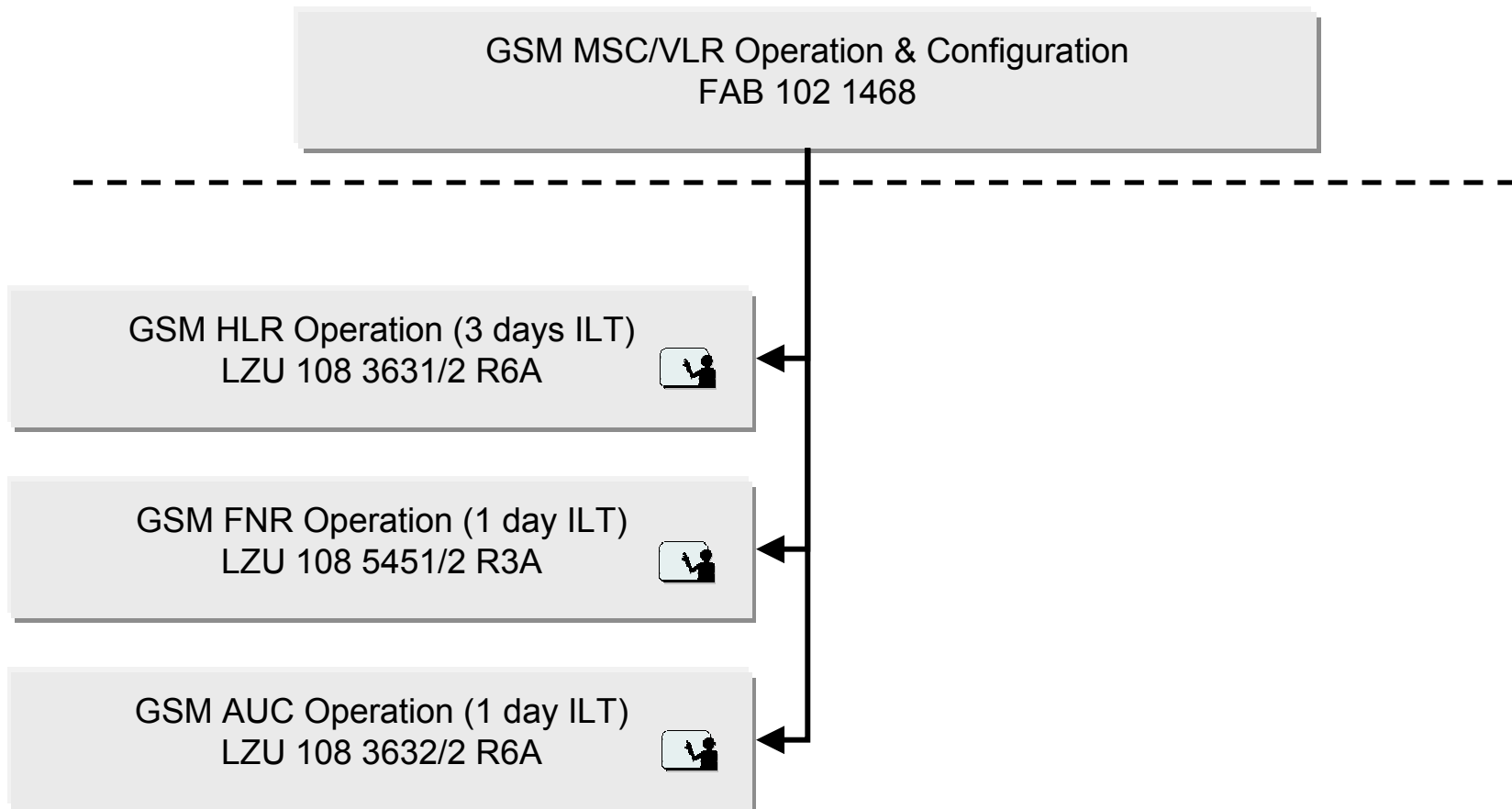

## GSM Core Network Advanced Operation (FAB 102 1470)

### Prerequisite Knowledge

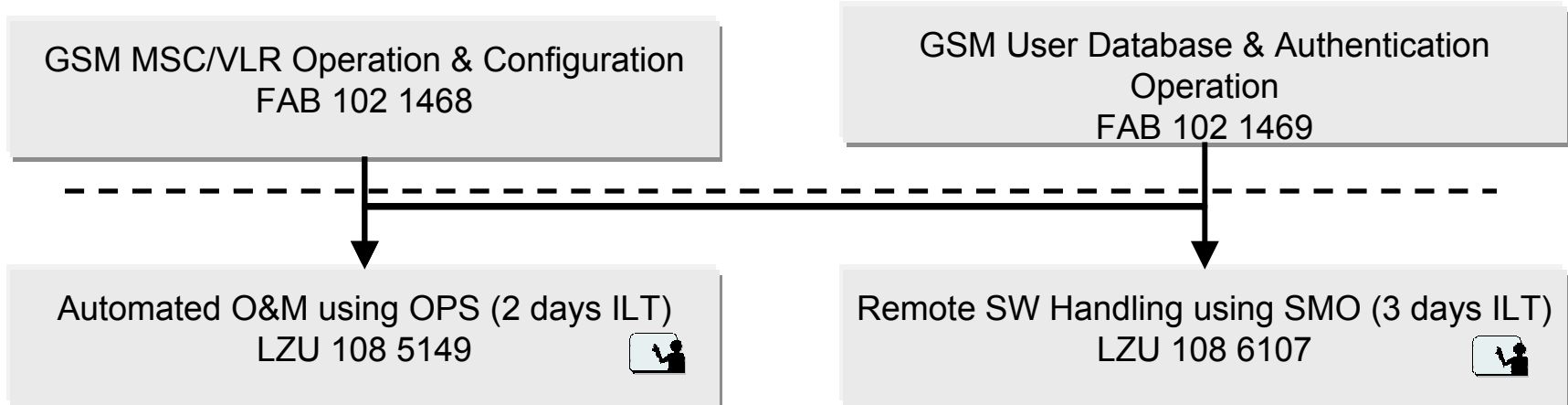

# GSM Mobile Media Gateway (M-MGW) Operation and Configuration (FAB 102 1471)

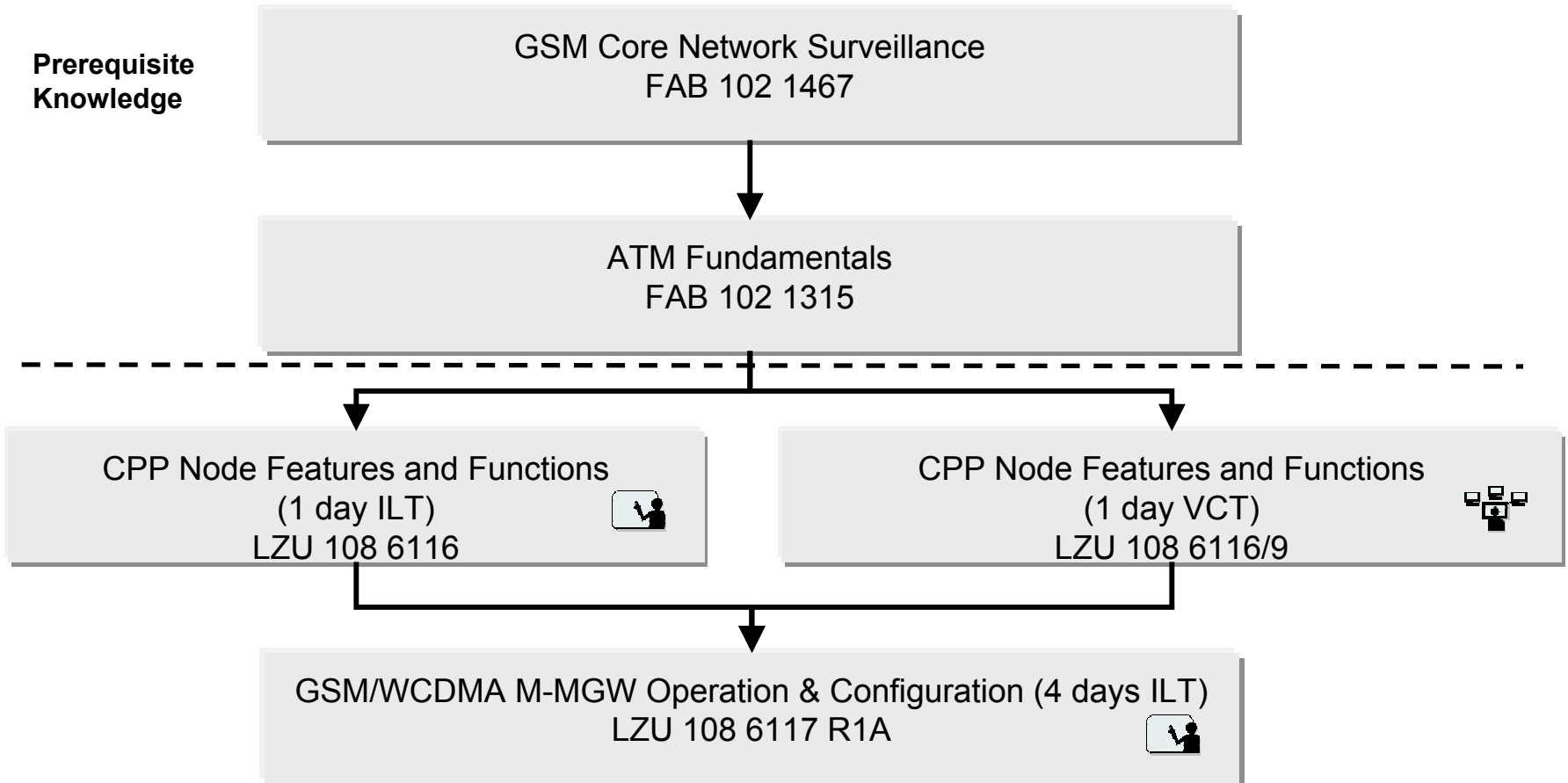

## GSM GSN Operation (FAB 102 1472)

### Prerequisite Knowledge

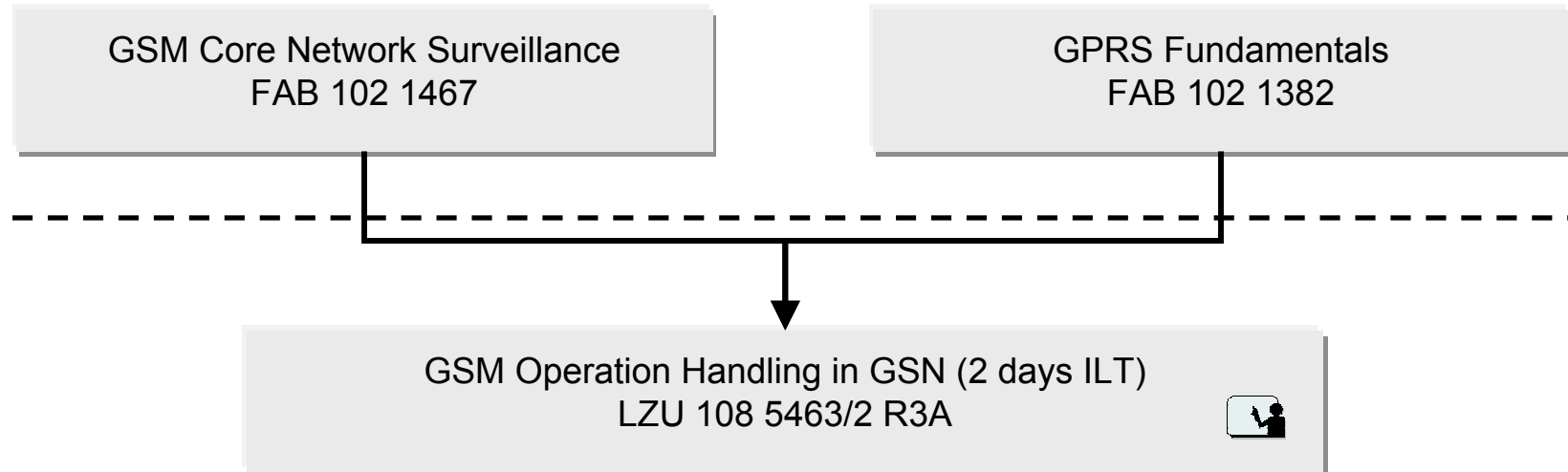

## GSM GSN Configuration (FAB 102 1473)

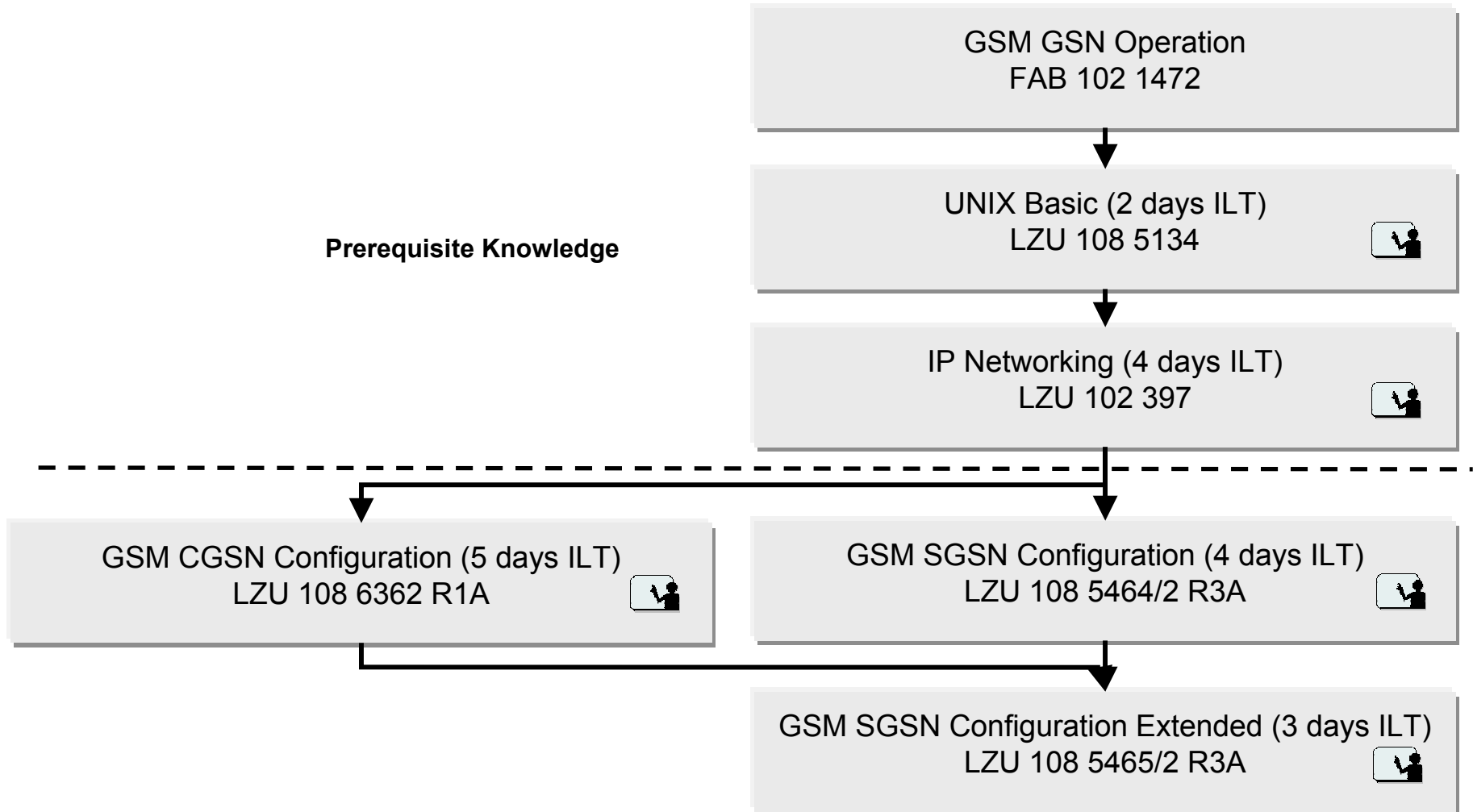

## GSM GSN System Administration (FAB 102 1474)

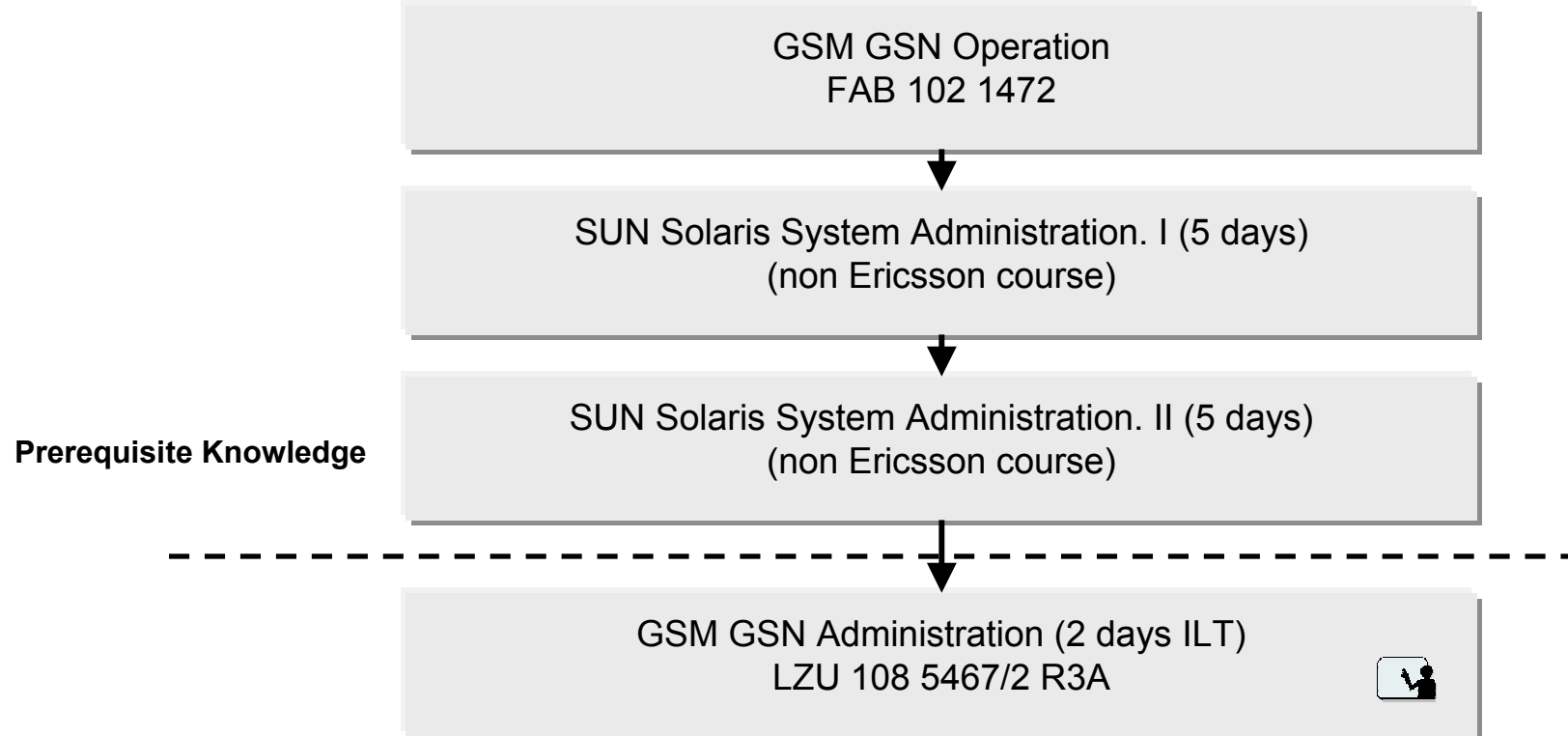

## GSM GSN Trouble Shooting (FAB 102 1475)

### Prerequisite Knowledge

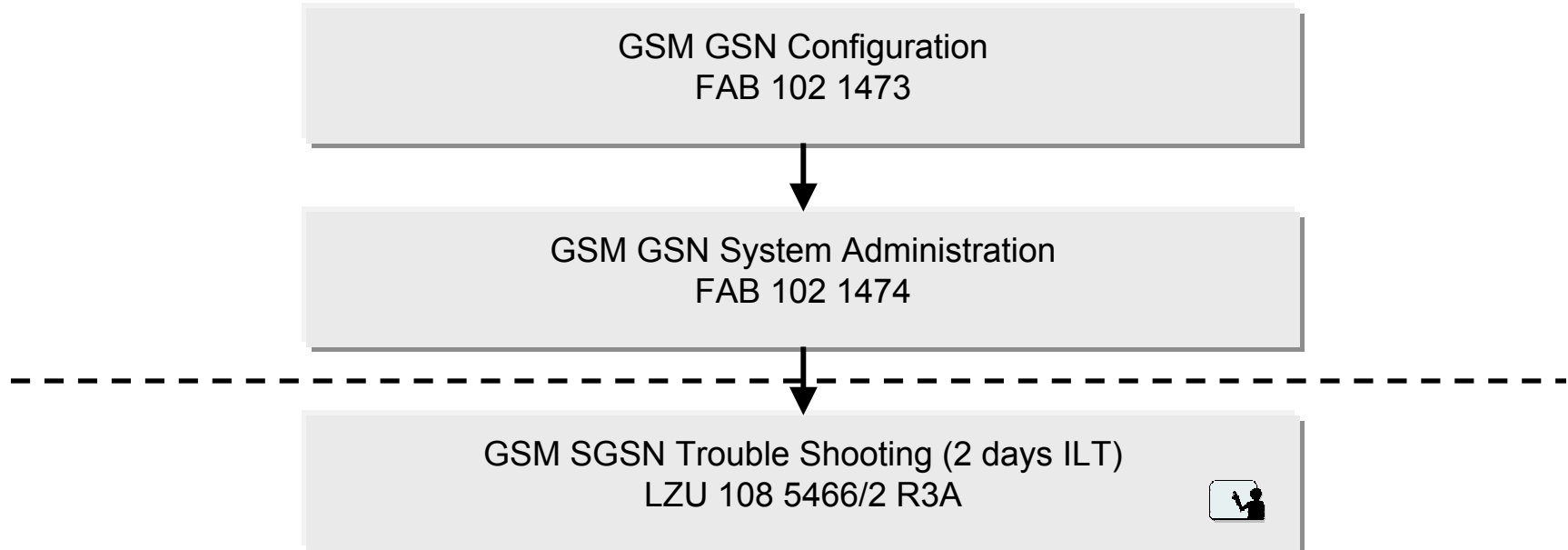

## J20 GGSN Configuration (FAB 102 1360)

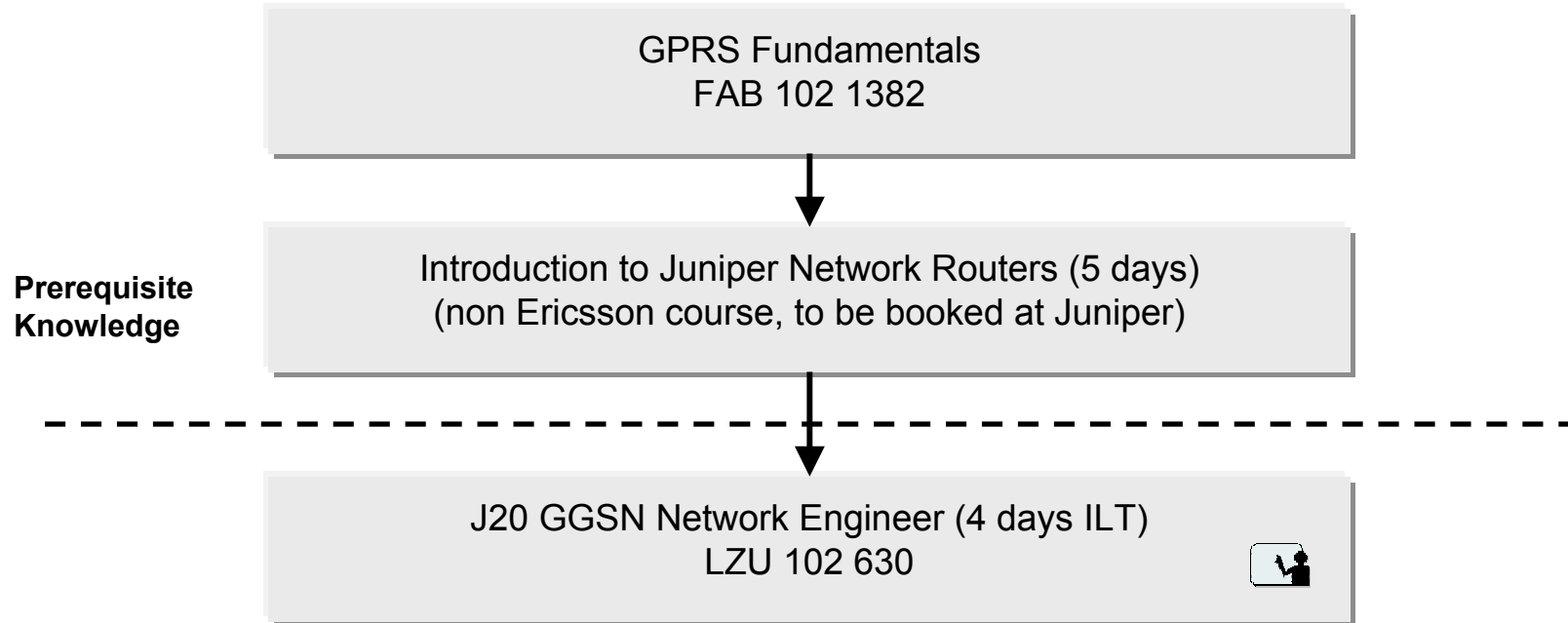

## GSM Core Network Advanced Configuration (FAB 102 1476)

### Prerequisite Knowledge

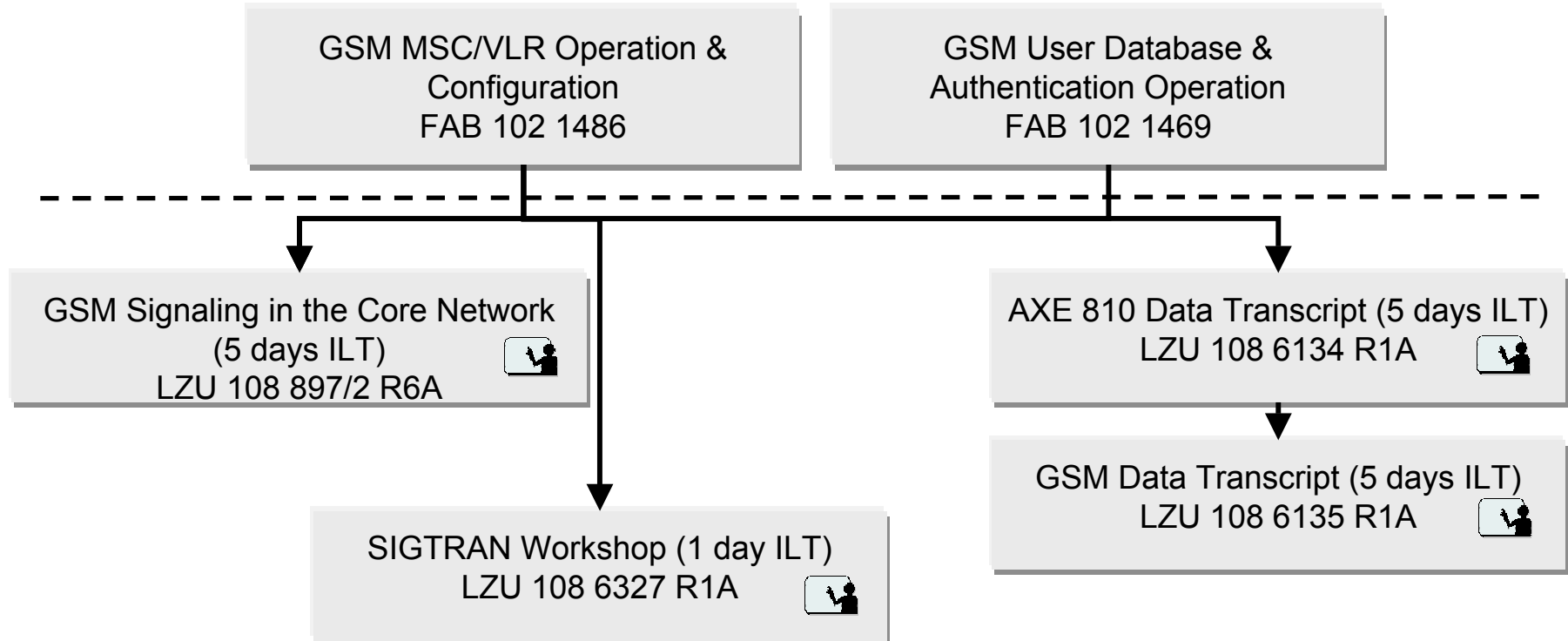

## GSM Layered Architecture Integration (FAB 102 1477)

**Prerequisite Knowledge**

Competence in Core Network Operation and Configuration, equivalent to at least GSM MSC/VLR Operation & Configuration (FAB 102 1468) in a non-layered GSM Core Network, or similar competence

GSM Layered Architecture Network Introduction (2 days ILT)  
LZU 108 6340 R1A 

GSM Media Gateway Operation & Configuration  
FAB 102 1471

And/  
Or

GSM MSC Server Configuration (1 day ILT)  
LZU 108 6363 R1A 

### GSM Layered Architecture Integration, hands-on training:

The integration or migration of a Core Network towards Layered Architecture (Mobile Softswitch) comprises different target groups and requires a variety of different competences. Thus, no single course, covering all target groups and all competences, is offered for the hands-on training part. Competence needs and delivery methods of training depend on the setup of the organisation, business goals and performance goals of the operator, as well as the specific target group. Ericsson Education can create a Learning Solution for this competence area, fitting the different target groups' competence needs according to the operator's goals. For more information on the concept of Learning Solution, please refer to the following link:

[http://www.ericsson.com/products/hp/Learning\\_Solutions\\_pos.shtml](http://www.ericsson.com/products/hp/Learning_Solutions_pos.shtml)

# GSM/WCDMA Core Network Charging Operation (FAB 102 1351)

## Prerequisite Knowledge

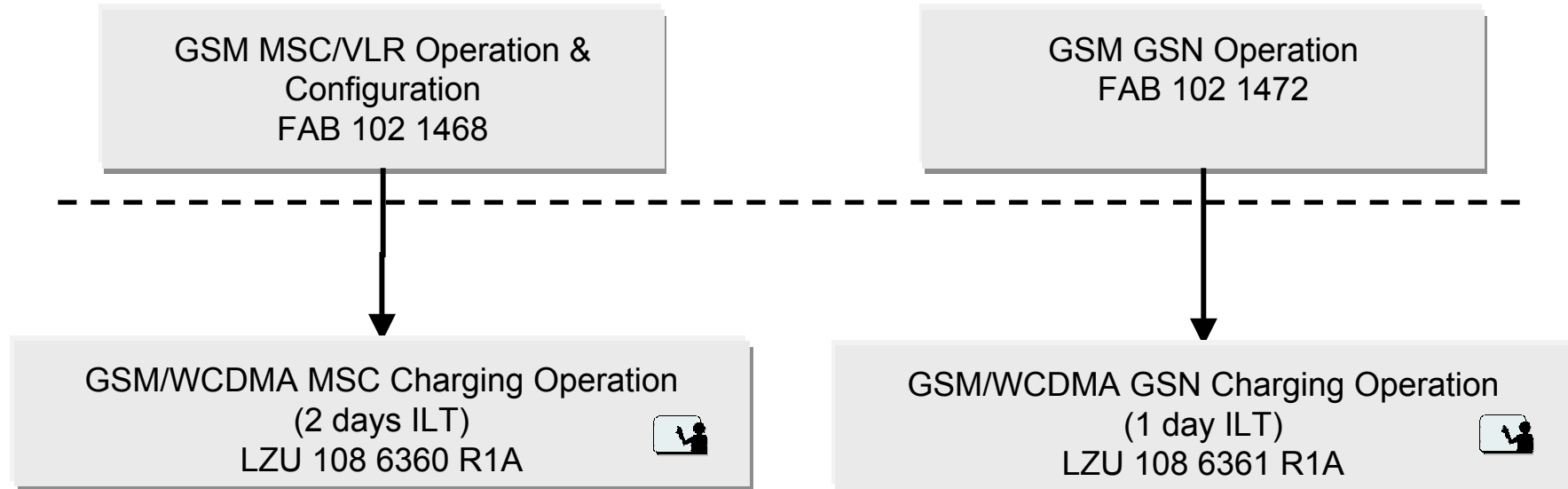

# GSM Core Network

## – Network Development –

## GSM Core Network Statistics Handling (FAB 102 1478)

**Prerequisite Knowledge**

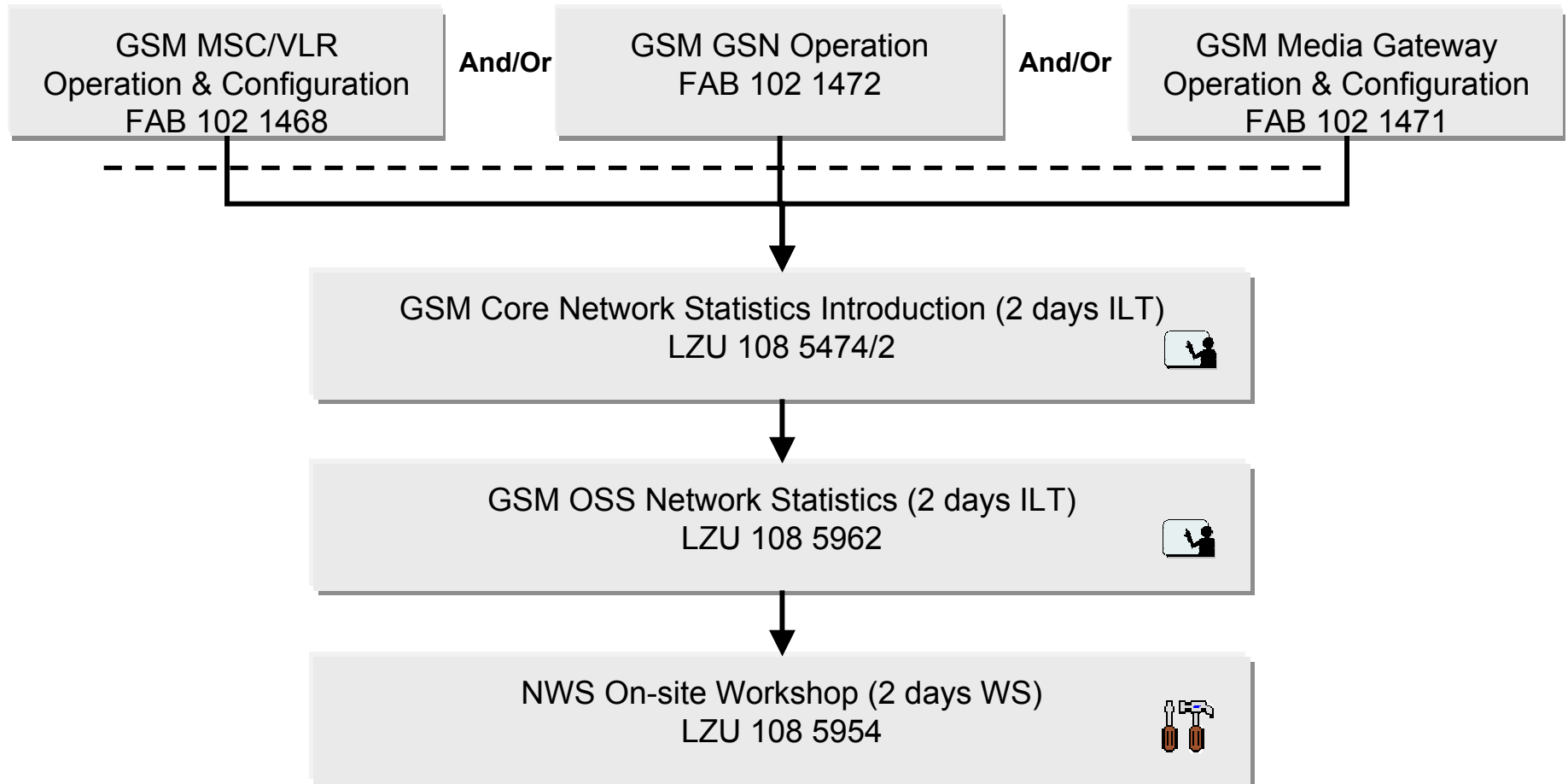

## GSM Core Network Planning (FAB 102 1479)

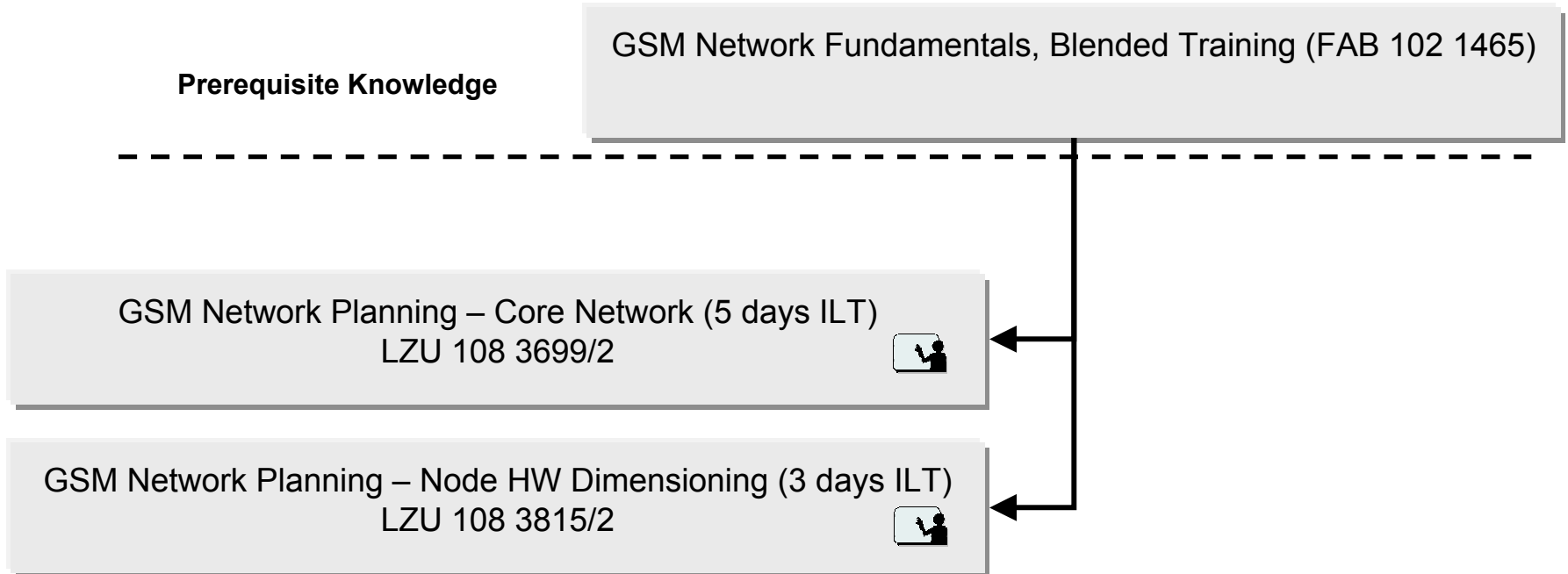

# **GSM Transport Network**

## **- Network Operation and Configuration-**

## AXD 301/305 Field Maintenance (FAB 102 1341)

Prerequisite  
Knowledge

ATM Fundamentals  
FAB 102 1315



AXD 301/305 Maintenance (1 day ILT)  
LZU 108 6130



# AXD 301/305 Network Operation & Configuration (FAB 102 1342)

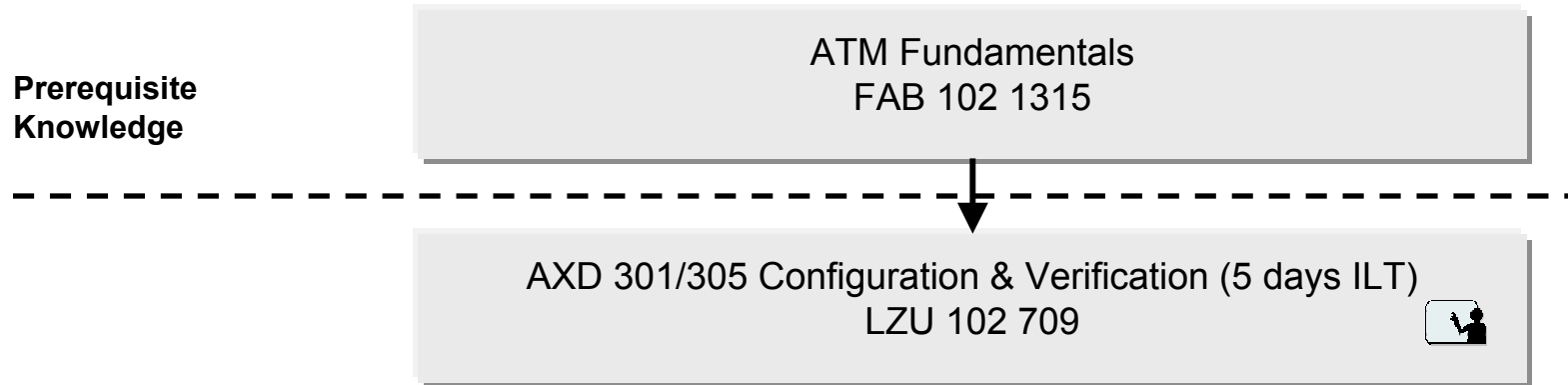

# GSM Network Management

## - Operation -

## OSS RC Introduction (FAB 102 1379)

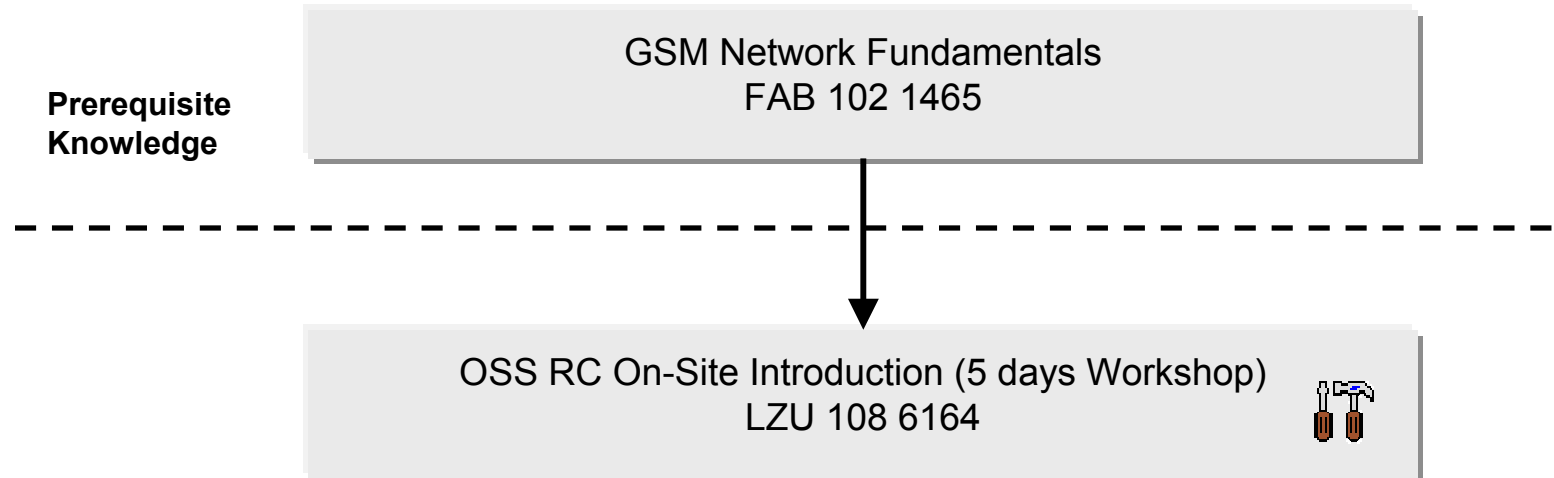

# **GSM Network Management**

## **- System Administration -**

## OSS RC System Administration (FAB 102 1481)

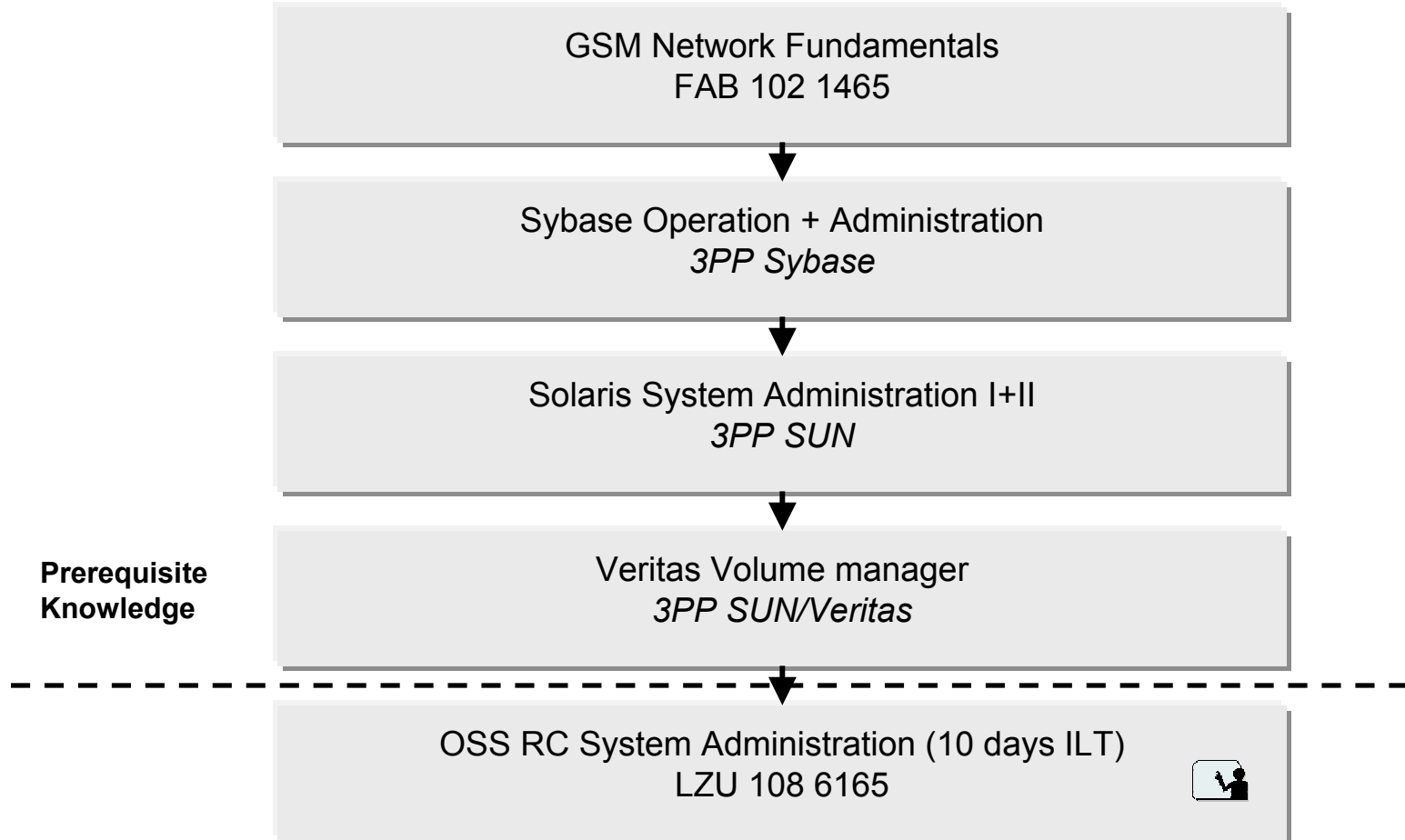

## Related training packages

The following related training packages can be found at

<http://www.ericsson.com/education/development/> :

- GSM RAN R10
- IP Multimedia
  
- The following Education Services can be found at [http://www.ericsson.com/products/services/training/learning\\_solutions.shtml](http://www.ericsson.com/products/services/training/learning_solutions.shtml)
  - Learning Solutions
  - Structured Knowledge Transfer (SKT)



## Name

### Position

**Ericsson AB**

**Business Unit Global Services**

Tel: + area code/ local number

Fax: + area code/ local number

Mob: +area code/ local number

e-mail: [xxx.xxx@ericsson.com](mailto:xxx.xxx@ericsson.com)

[www.ericsson.com/products/services/training.shtml](http://www.ericsson.com/products/services/training.shtml)