

GSM R12 Core Network Training Programs

Package Presentation



Name

Title

Ericsson Global Services

xxxxx.xxxxx@ericsson.com

Why invest in GSM R12 Core Network Package







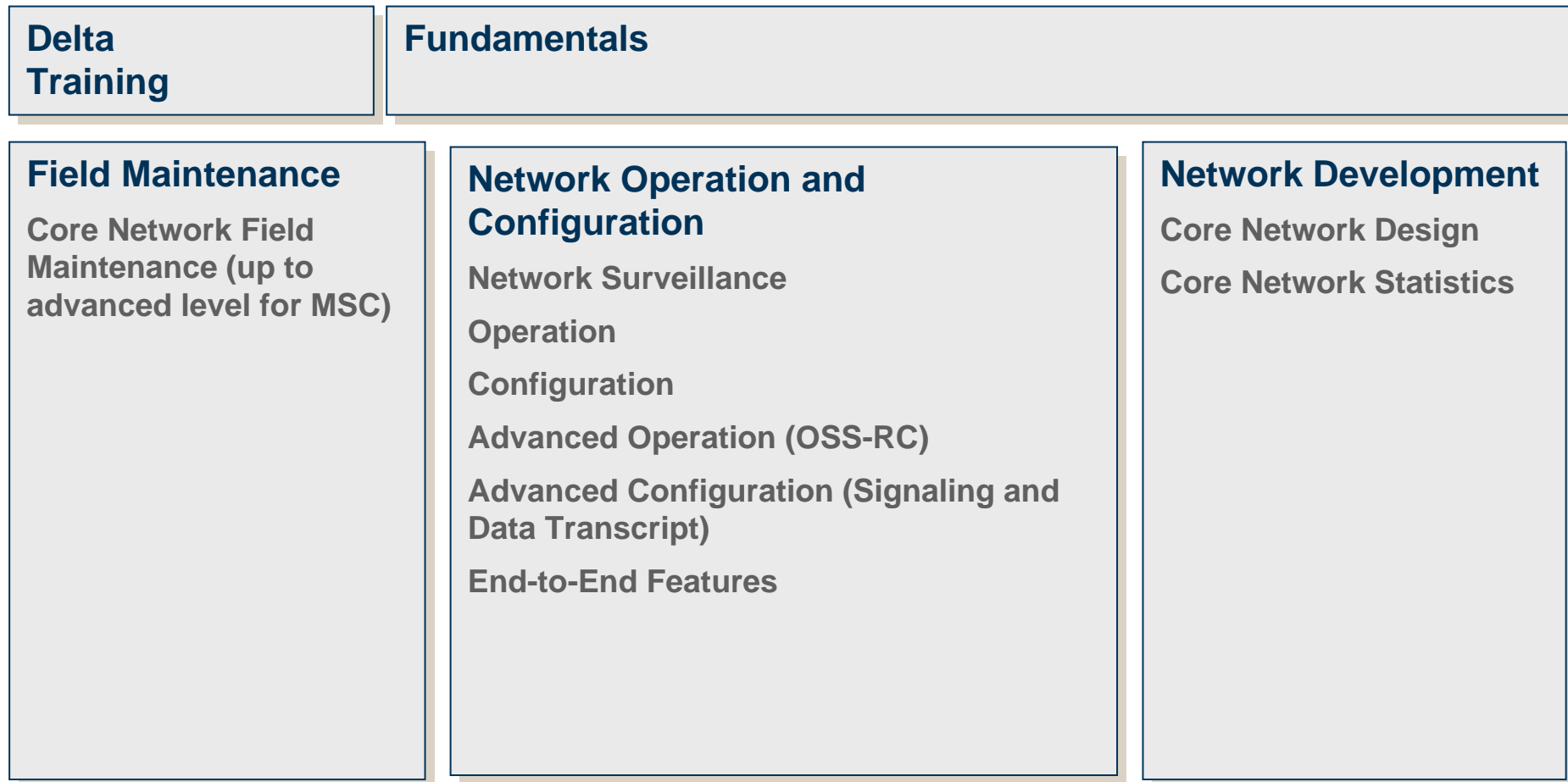

- **The package is divided into modular flows for each work area and each node and platform in the GSM Core Network. Combinations of these flows exactly match the job functions at the operator.**
- **The modularity of the portfolio ensures the shortest time for competence built-up of each target group**
- **The training flows are valid for personnel coming newly into the area of GSM as well as for experienced personnel in need of the “Delta” information for the new release or new functionality.**
- **The training flows provide a career model from basic to very advanced and specialized competence.**
- **The training offering closes competence gaps when going into new areas like MSS, SACC and end-to-end solutions.**

What's in the GSM R12 Core Network Package?

Target Audience & Competence Levels



Supported Service Delivery Methods

Icon	Delivery Method
	Instructor Led Training (ILT)
	Seminar (SEM)
	Workshop (WS)
	Virtual Classroom Training (VCT)
	Web Based Learning (WBL)
	Short Article (SA)
	Streaming Video (SV)
	CD-ROM (CD)
	Structured Knowledge Transfer (SKT)

GSM R12 CORE NETWORK

- DELTA TRAINING -

APZ212 50 and APG40 Delta

(FAB 102 1844 R1A)

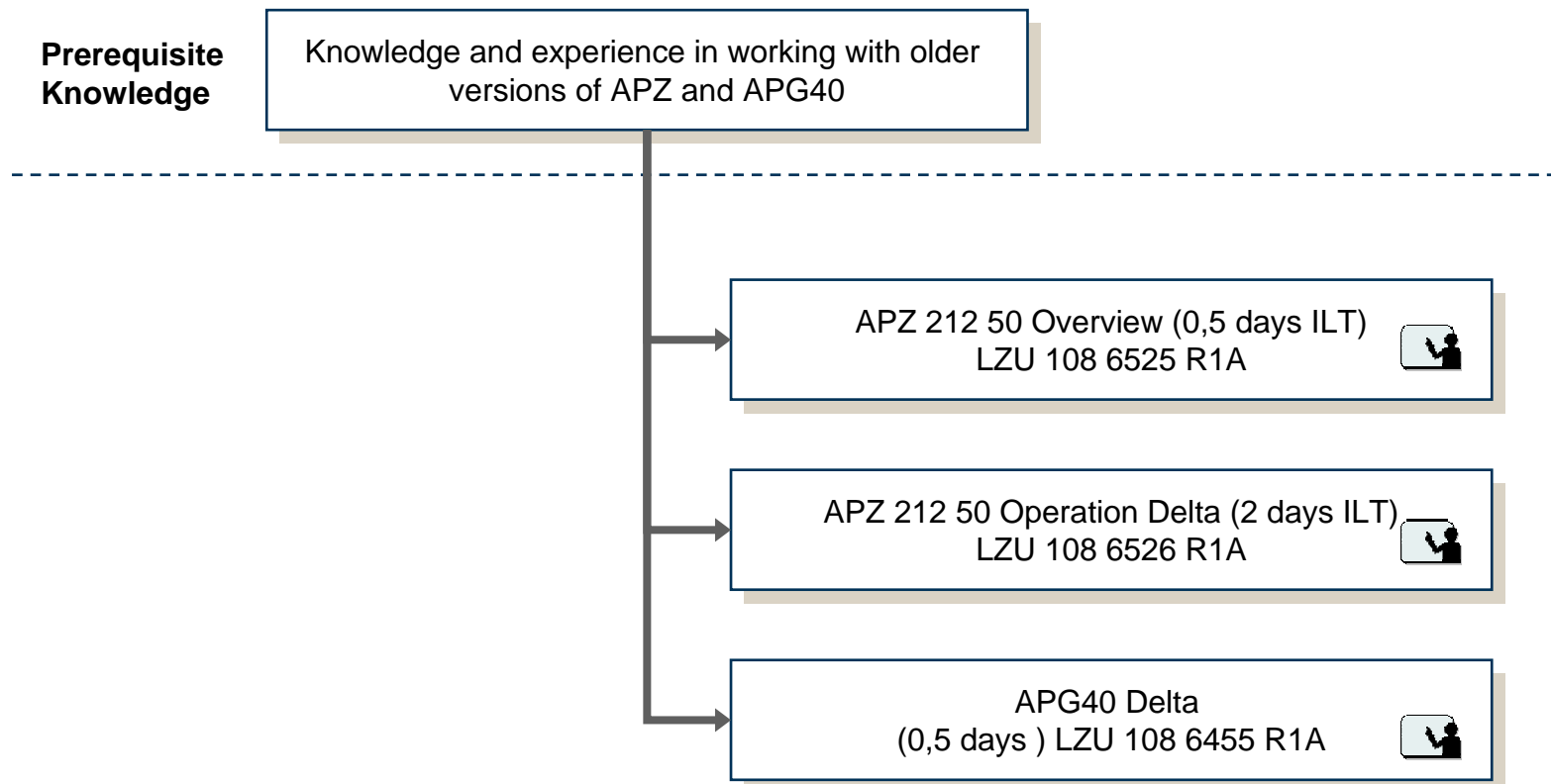

GSM R12/WCDMA R5 Mobile Core Network Delta Training

(FAB 102 1845 R1A)

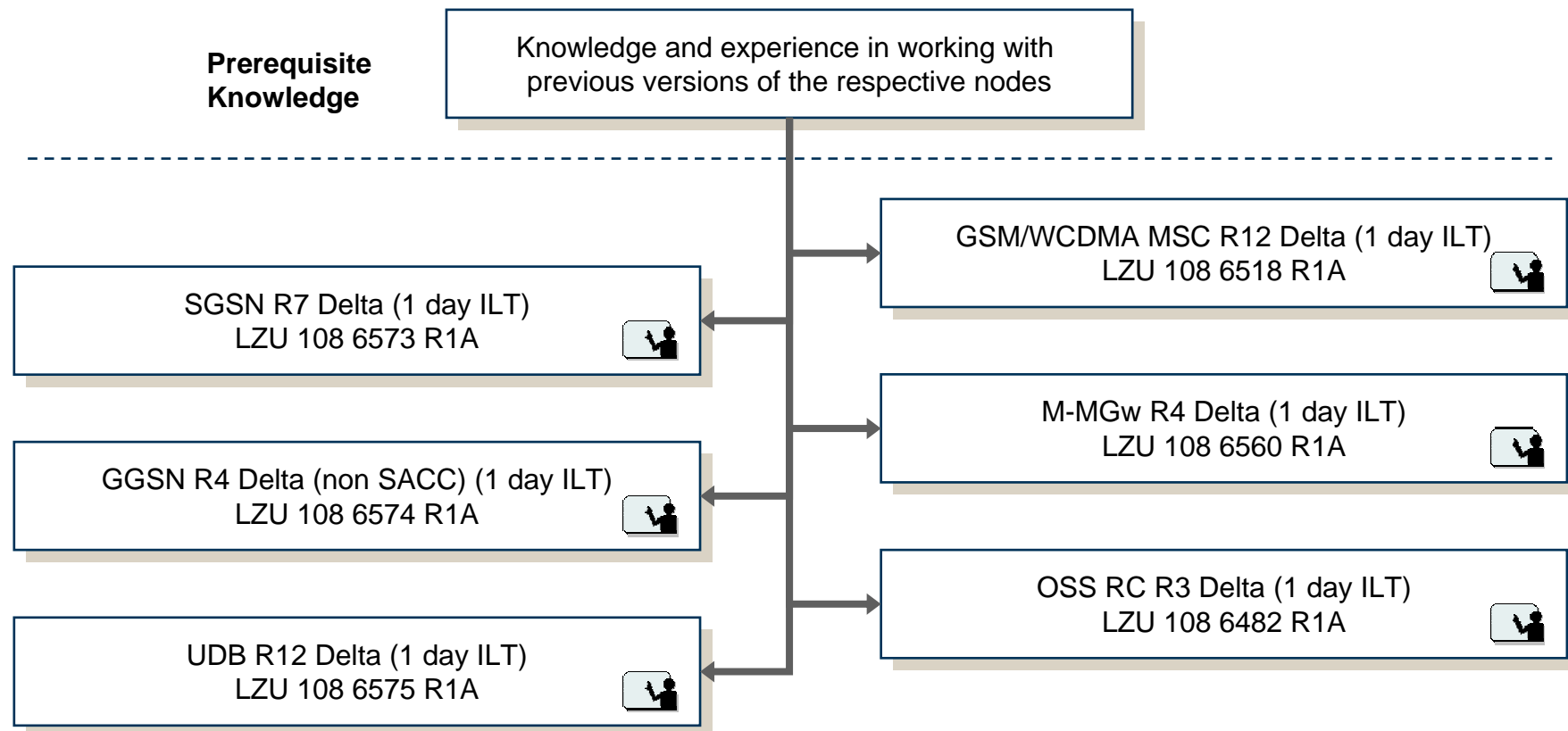

GSM NETWORK

- FUNDAMENTALS -

Introduction to IP Networks, WBL

(FAB 102 1313 R1A)

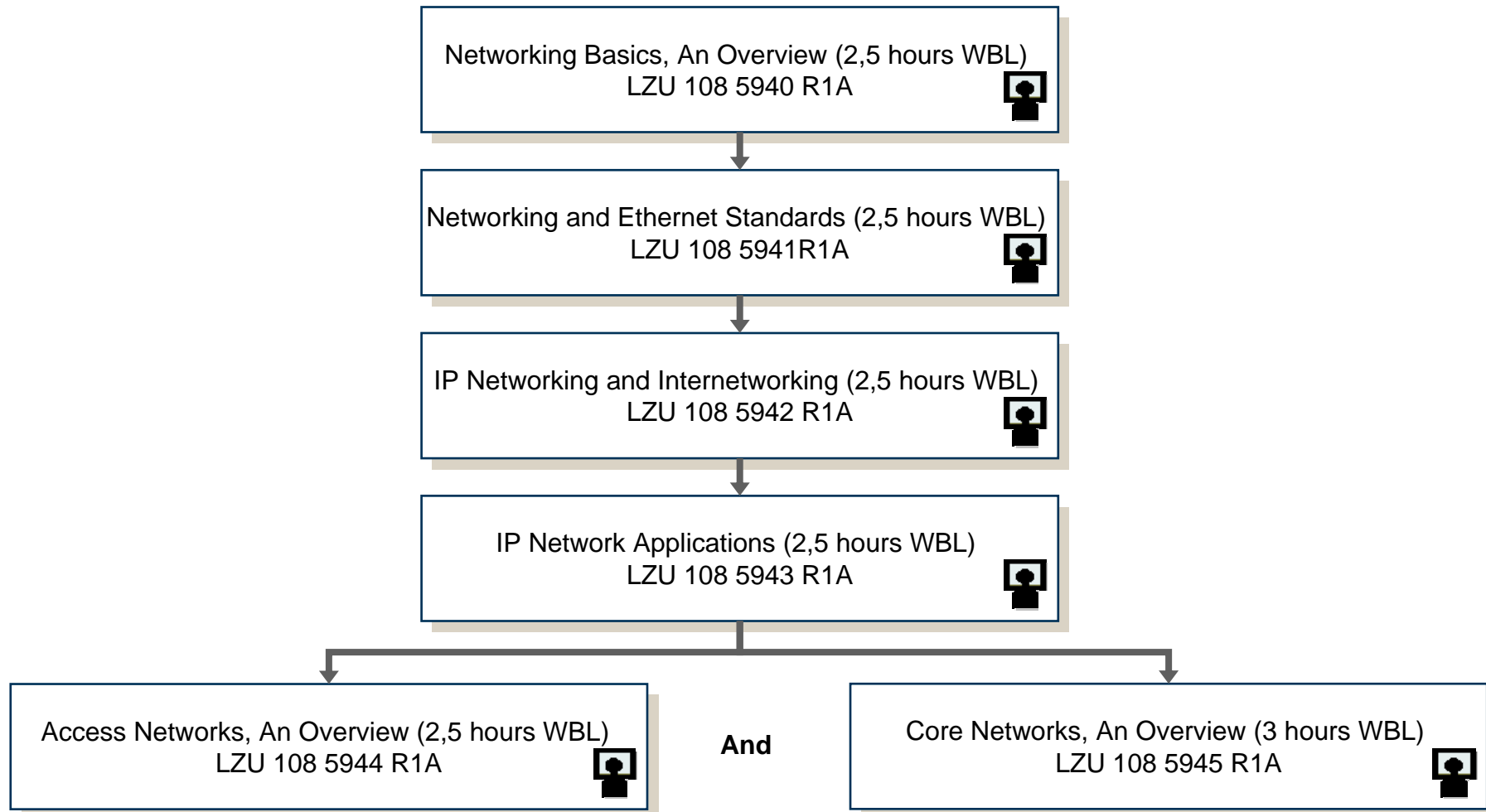

IP Fundamentals

(FAB 102 1314 R2A)

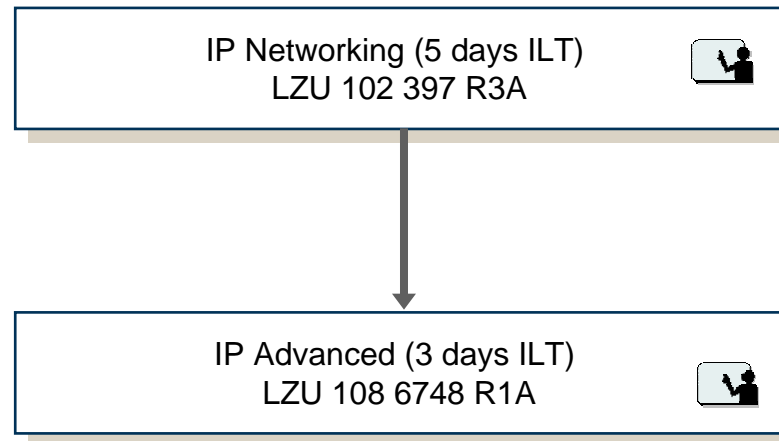

IPv6 Fundamentals

(FAB 102 1383 R1A)

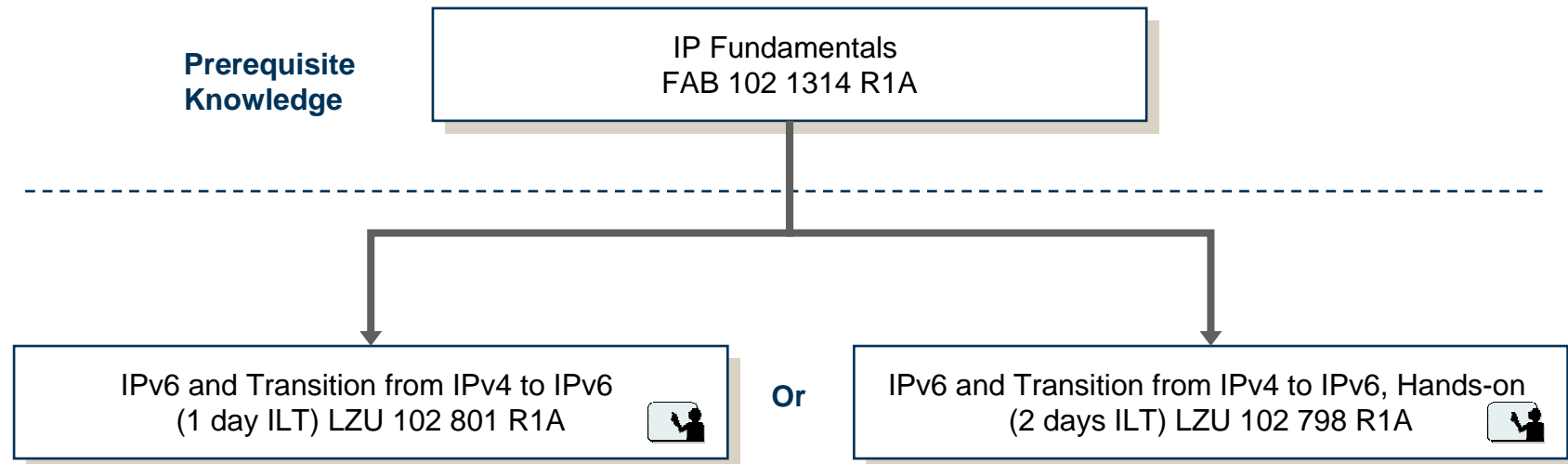

IPv6 Routing Configuration

(FAB 102 1384 R1A)

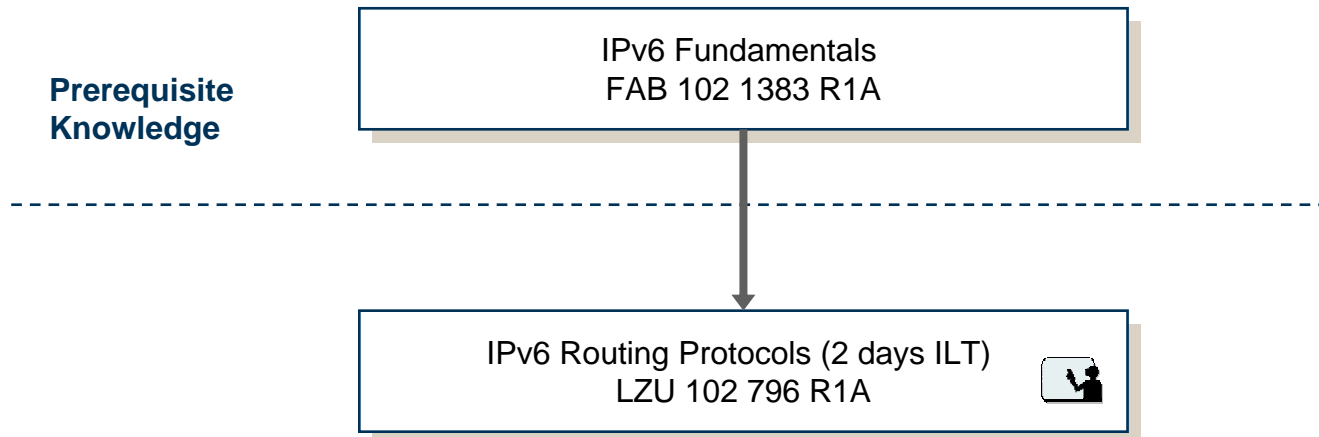

IPv6 Advanced Network Configuration

(FAB 102 1385 R1A)

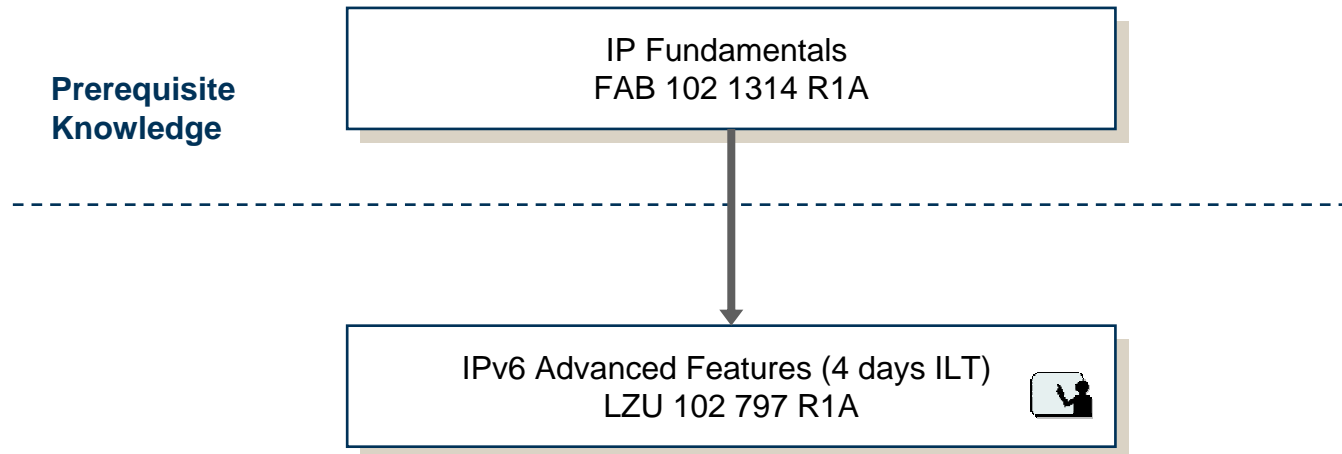

ATM Fundamentals

(FAB 102 1315 R2A)

Prerequisite Knowledge

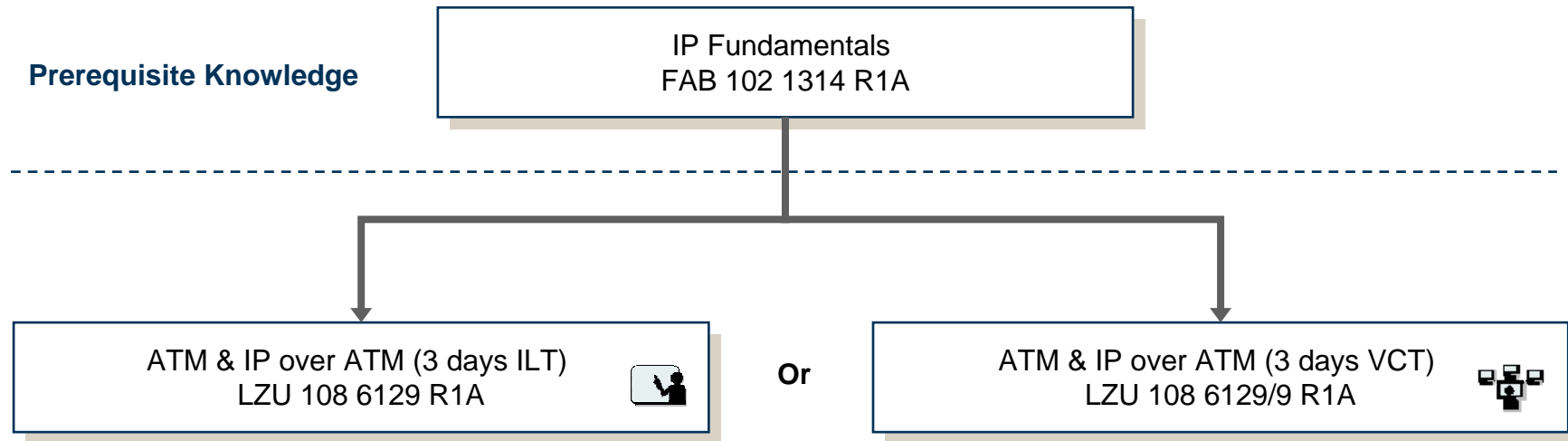

GSM Network Fundamentals, Blended Training

(FAB 102 1465 R1A)

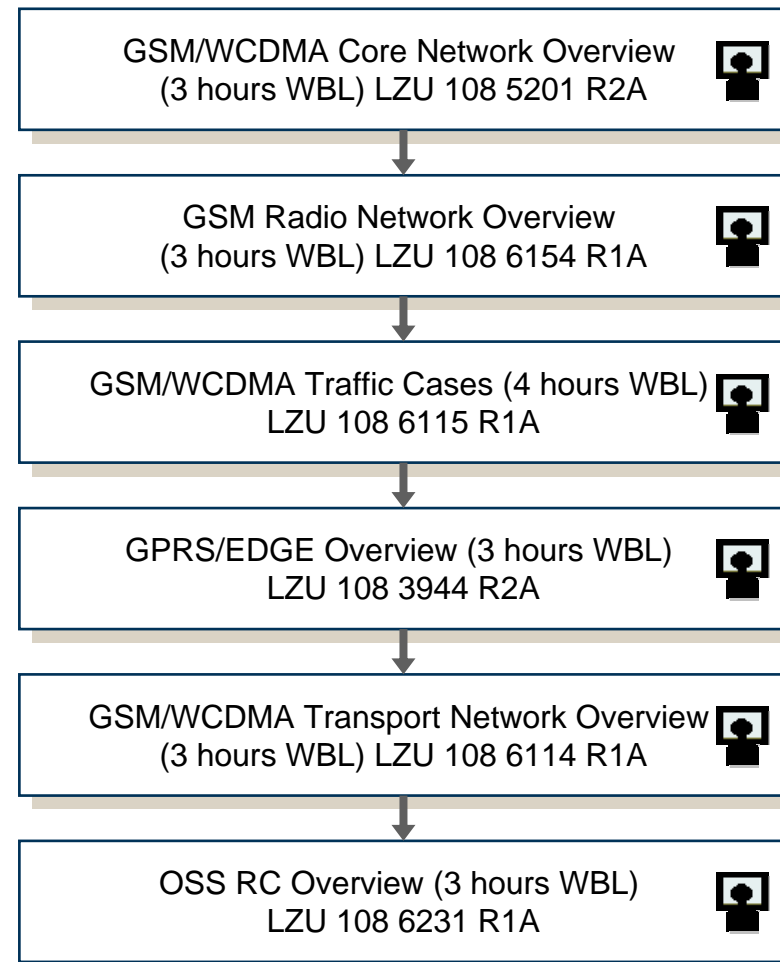
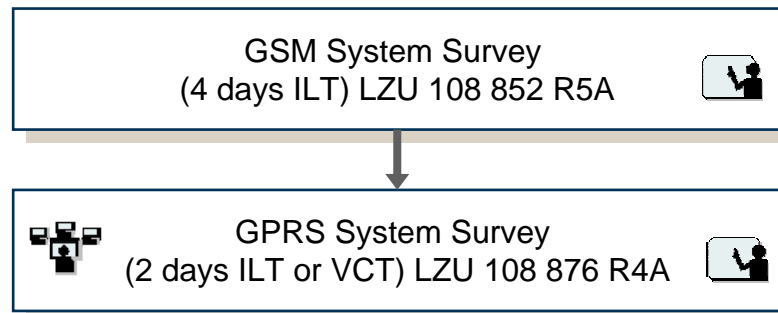

Note: The order of the WBL courses is the recommended one, but in fact the courses could be taken in any order.

GSM CORE NETWORK

- FIELD MAINTENANCE -

GSM Core Network Maintenance

(FAB 102 1466 R2A)

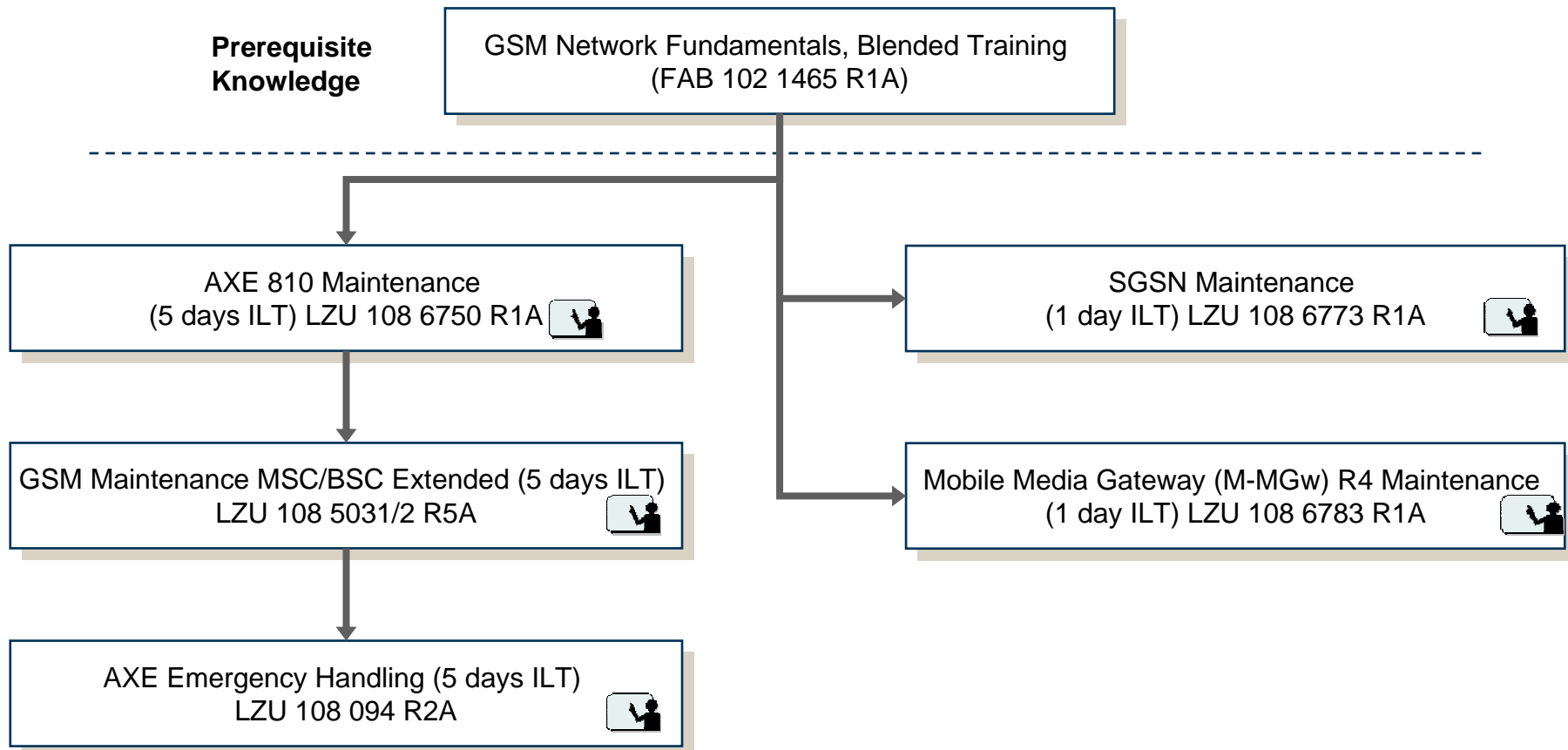

GSM CORE NETWORK

- NETWORK OPERATION AND CONFIGURATION -

APG 40 (NT4) Node Operation & Configuration

(FAB 102 1345 R1A)

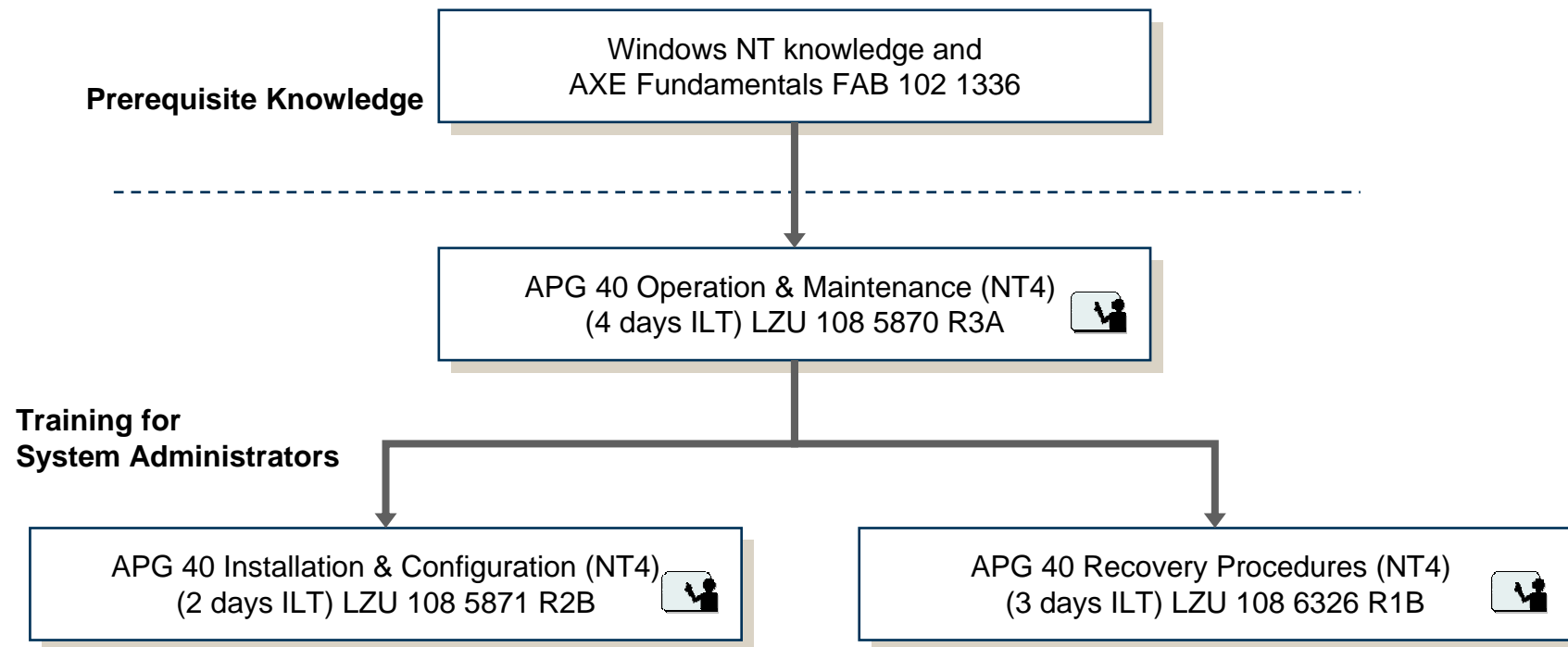

APG 40 (Windows 2003 C2) Node Operation & Configuration (FAB 102 1847 R1A)

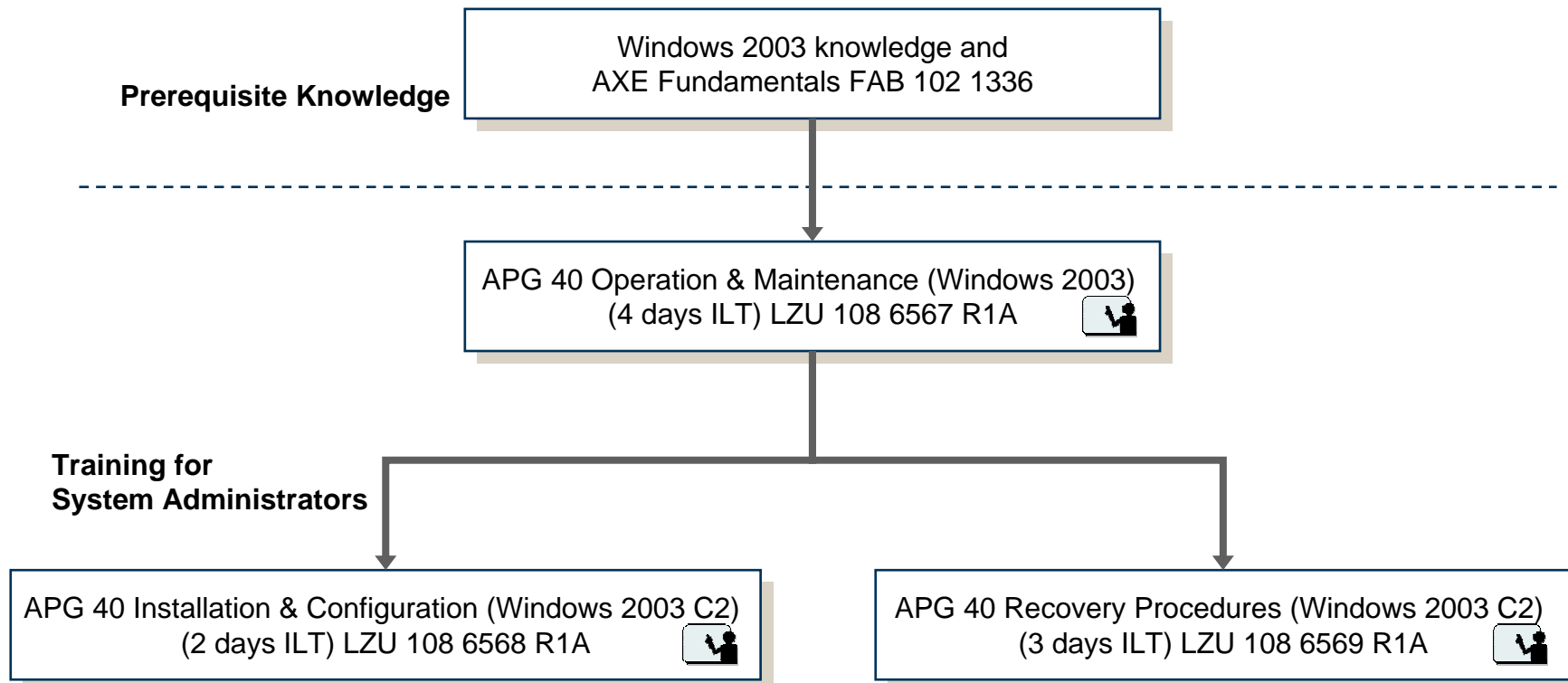

APG 40 (Windows 2003 C4) Node Operation & Configuration (FAB 102 1911 R1A)

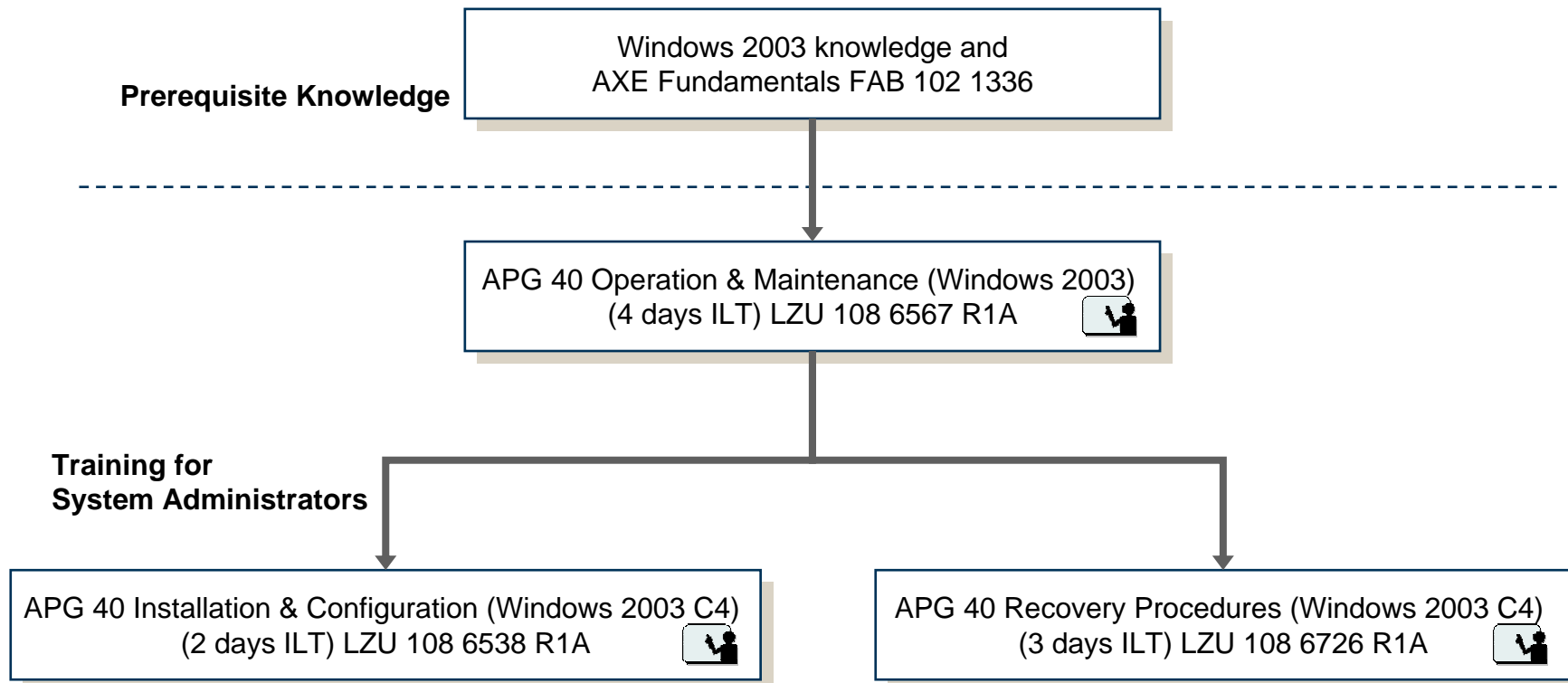

GSM R12 MSC/MSC-S Operation & Configuration

(FAB 102 1850 R1A)

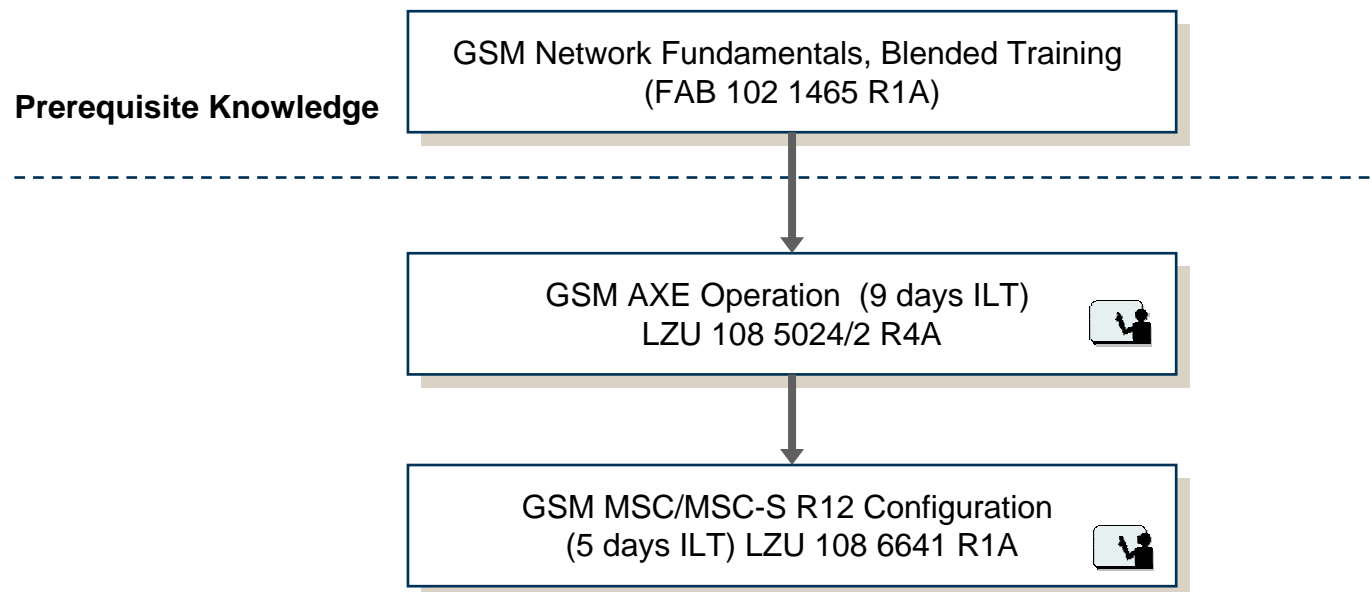

Note: Ericsson Education offers completing the competence development of the operator in the area of operating a WCDMA MSC by delivering a Structured Knowledge Transfer (SKT) Service on-site. For more information on SKT please refer to

<http://www.ericsson.com/products/services/training/skt.shtml>

GSM R12/ WCDMA R5 User Database & Authentication Operation (FAB 102 1849 R1A)

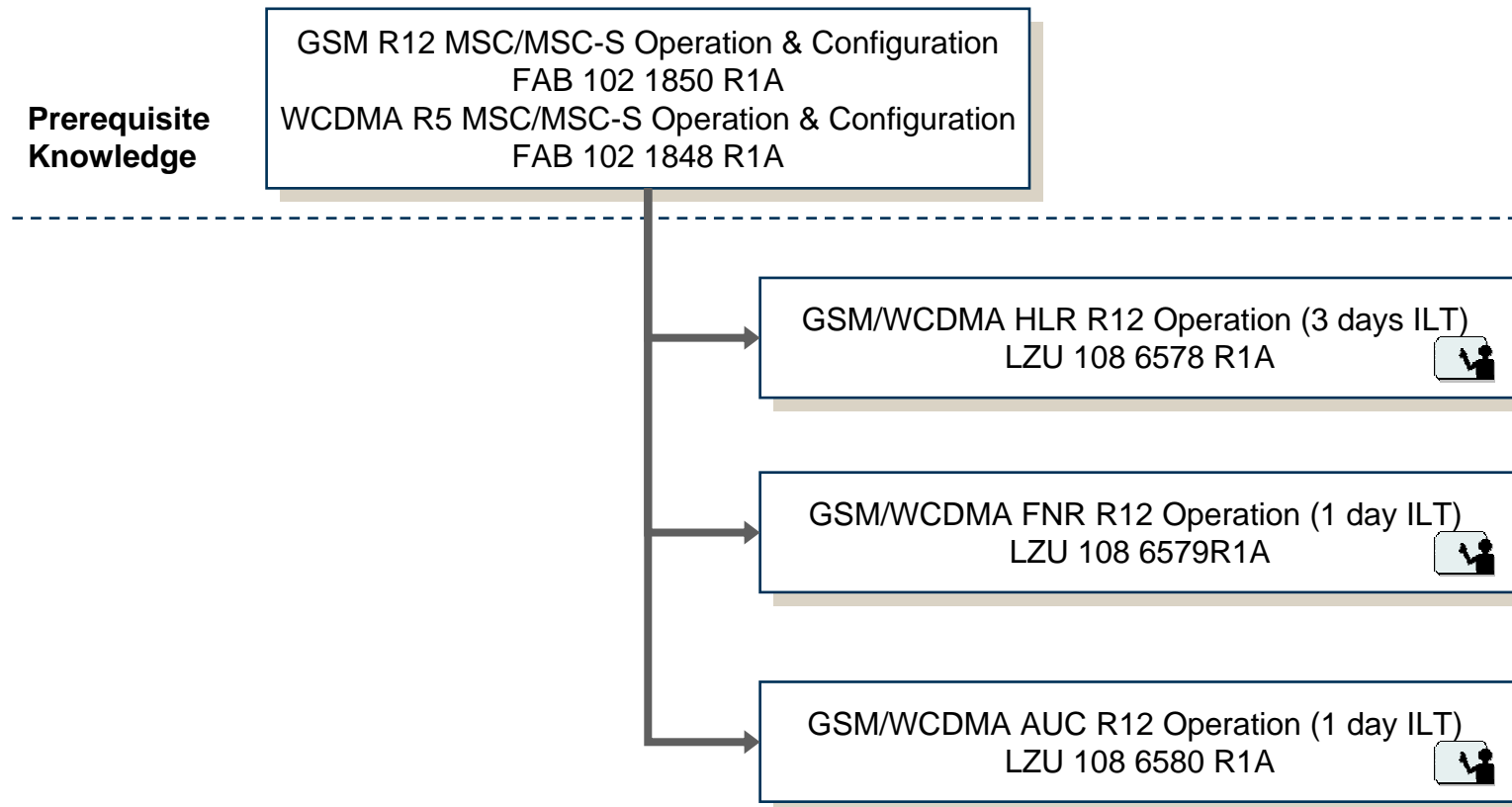

GSM/WCDMA Mobile Media Gateway (M-MGW) R4 Operation and Configuration (FAB 102 1851 R1A)

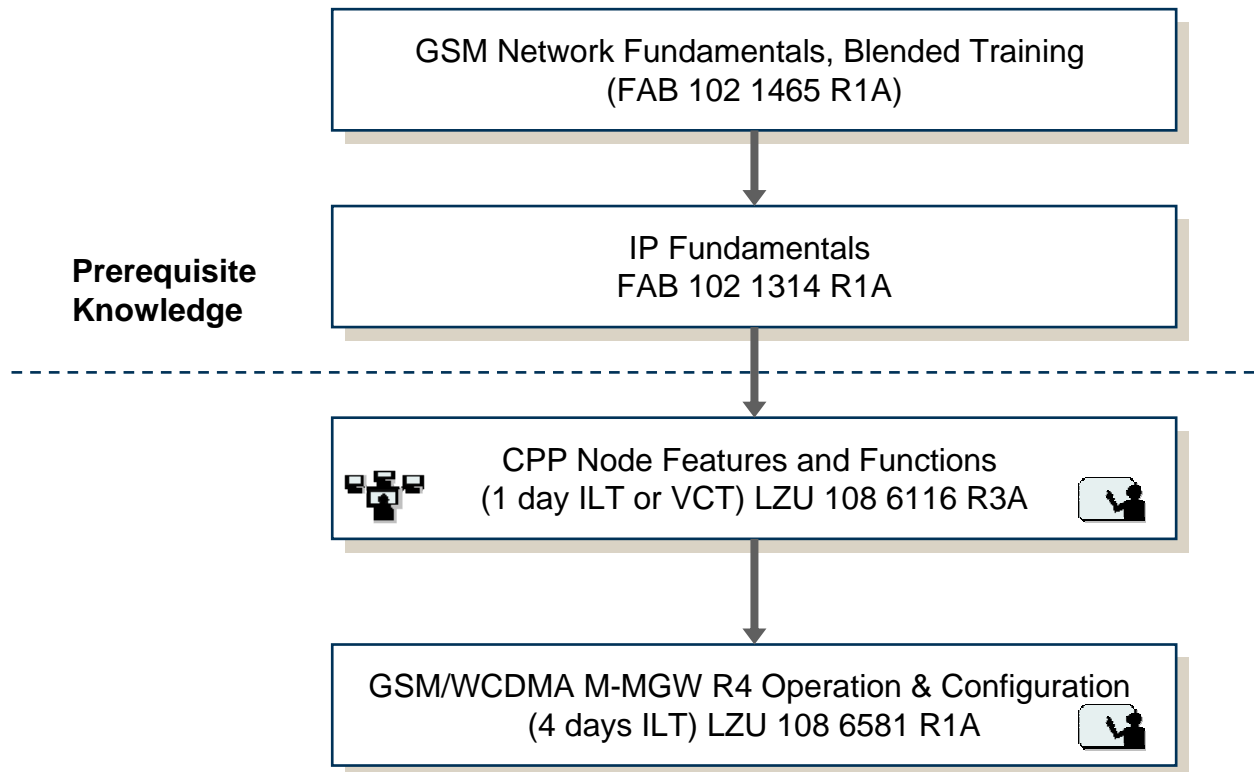

GSM/WCDMA SGSN R7 Operation (FAB 102 1852 R1A)

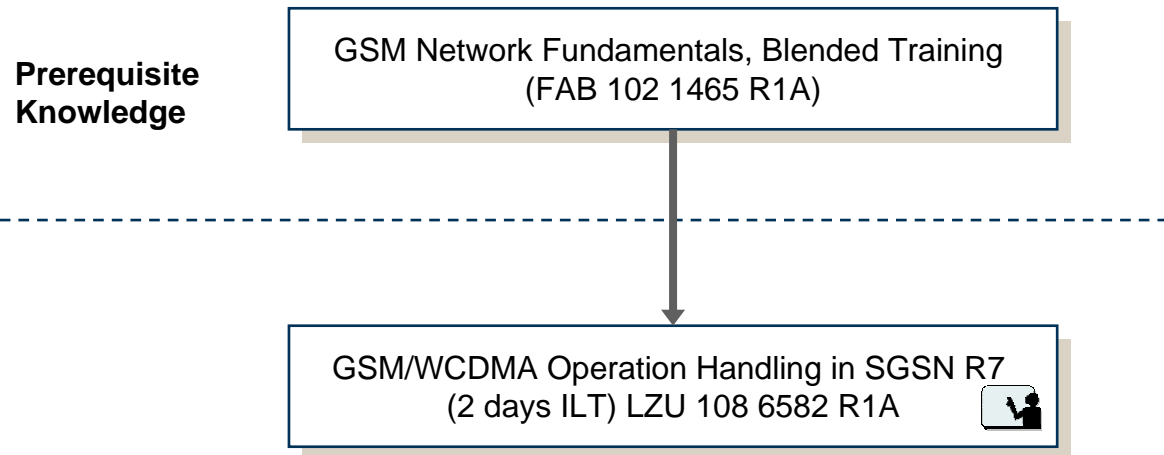

GSM/WCDMA SGSN R7 Configuration (FAB 102 1853 R1A)

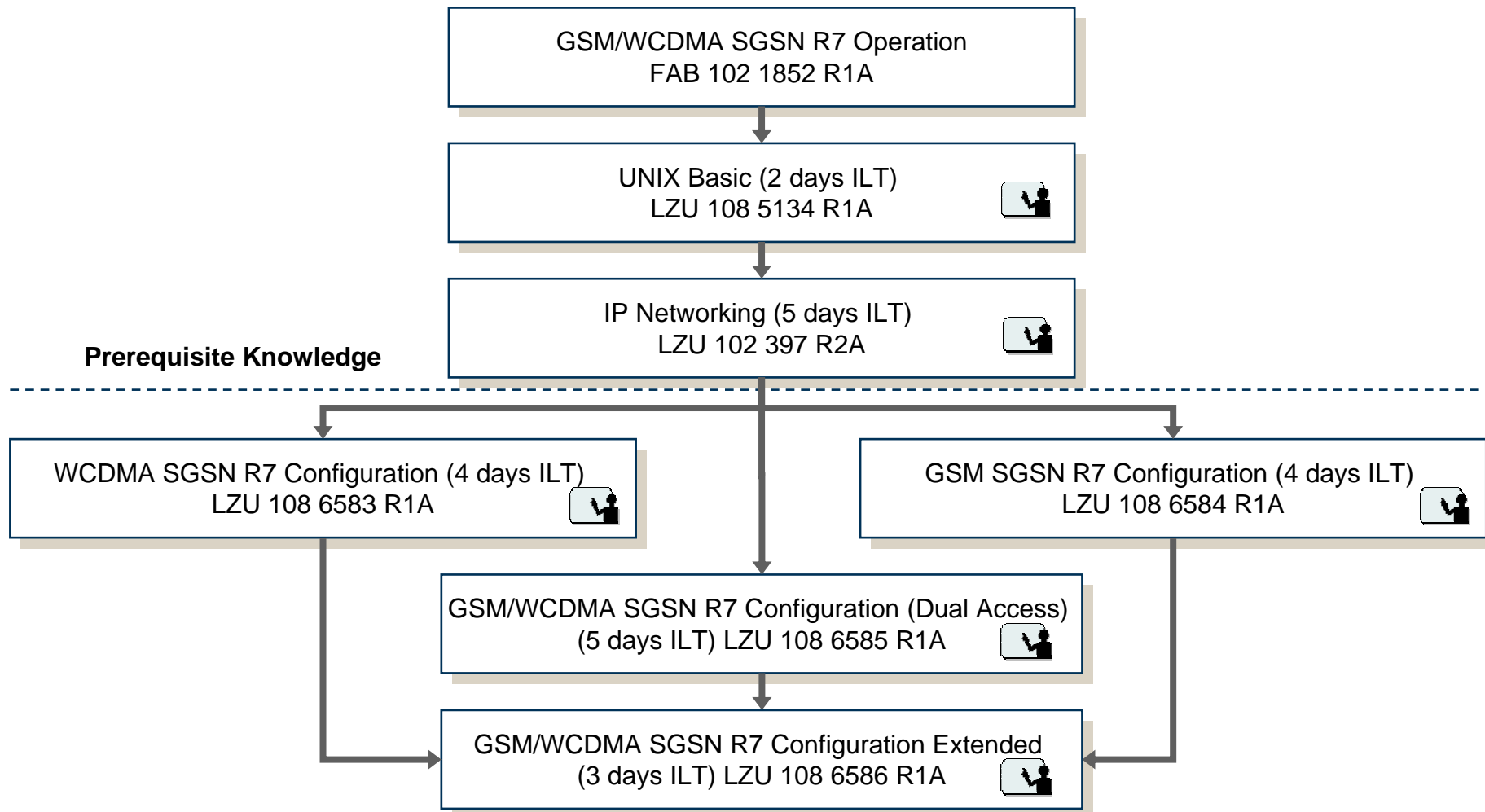

GSM/WCDMA SGSN R7 System Administration (FAB 102 1854 R1A)

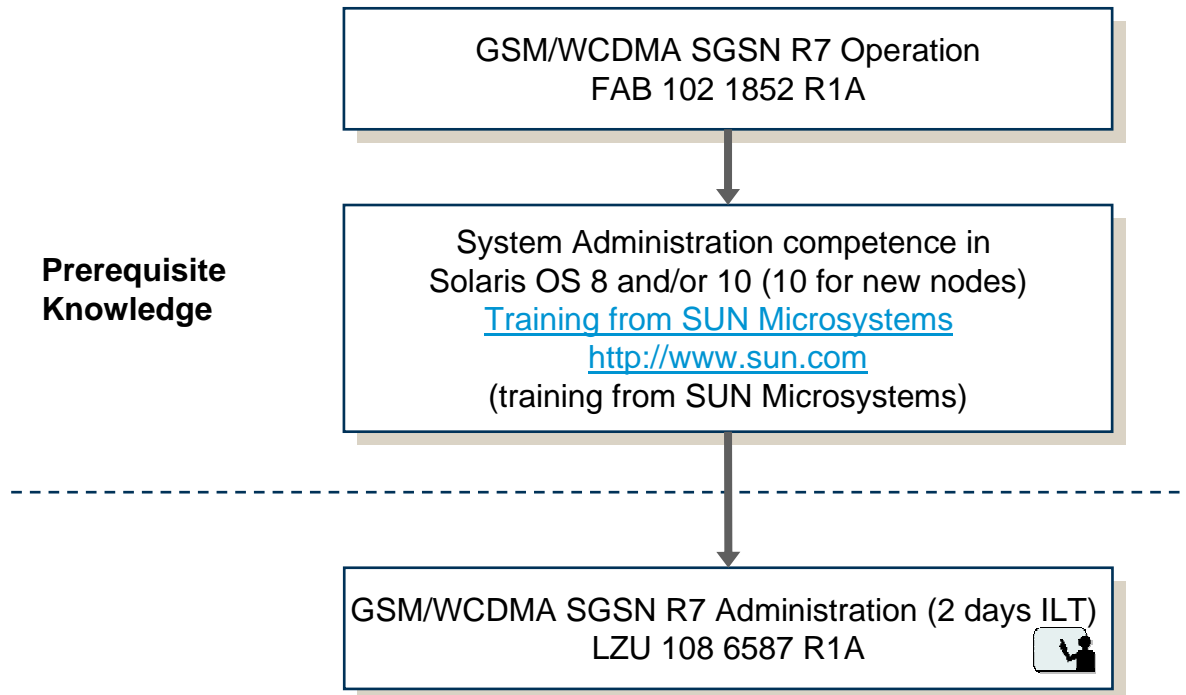

GSM/WCDMA SGSN R7 Trouble Shooting (FAB 102 1855 R1A)

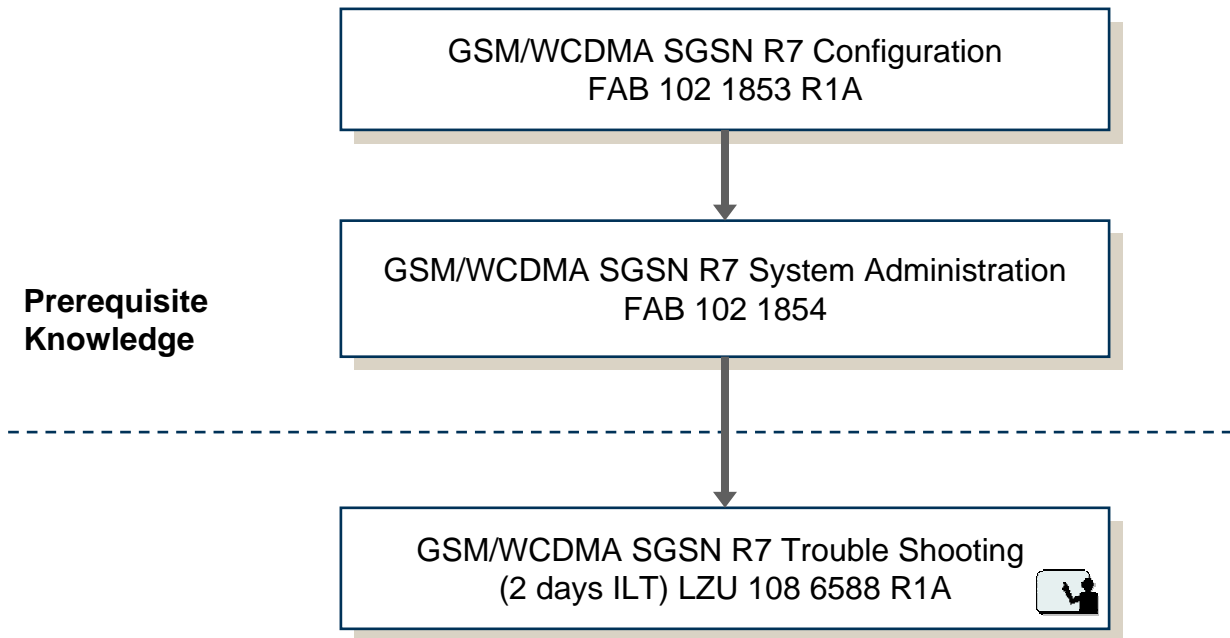

J20 GGSN R3 Configuration

(FAB 102 1842 R1A)

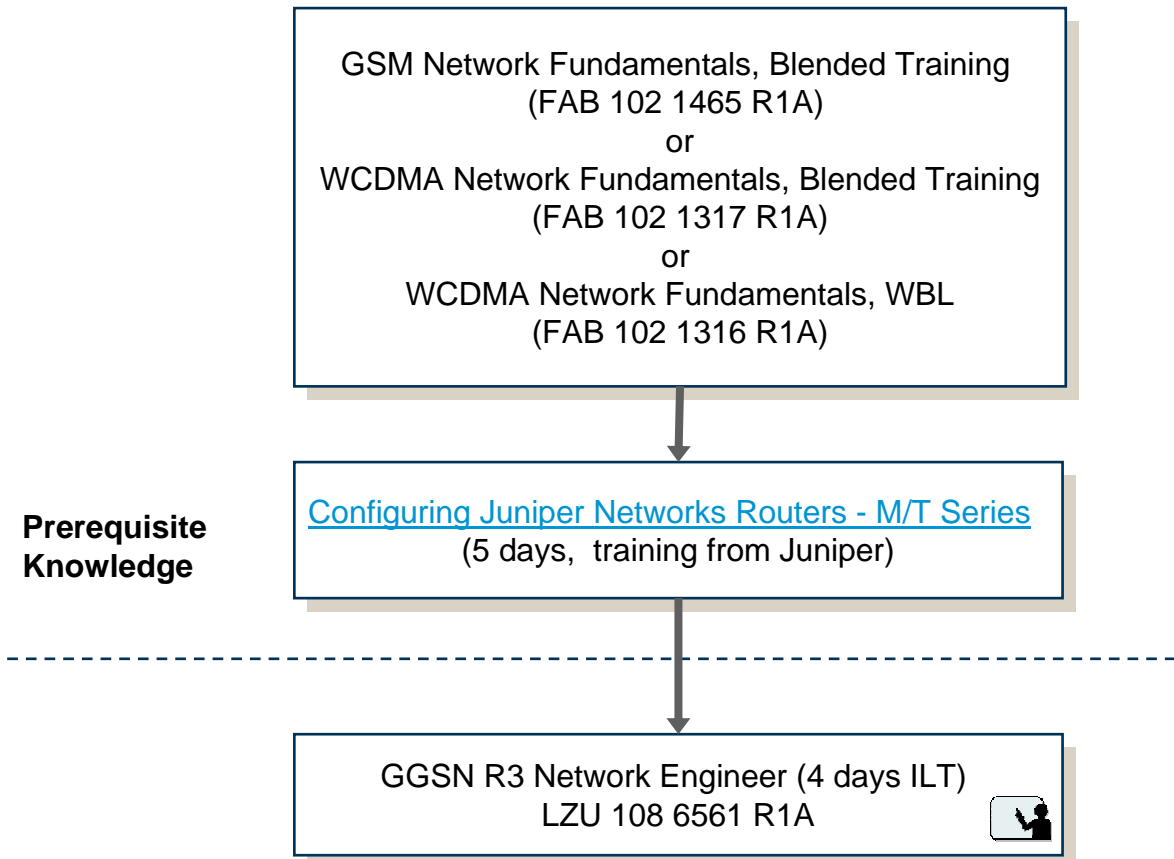

GGSN R4 Configuration

(FAB 102 1856 R1A)

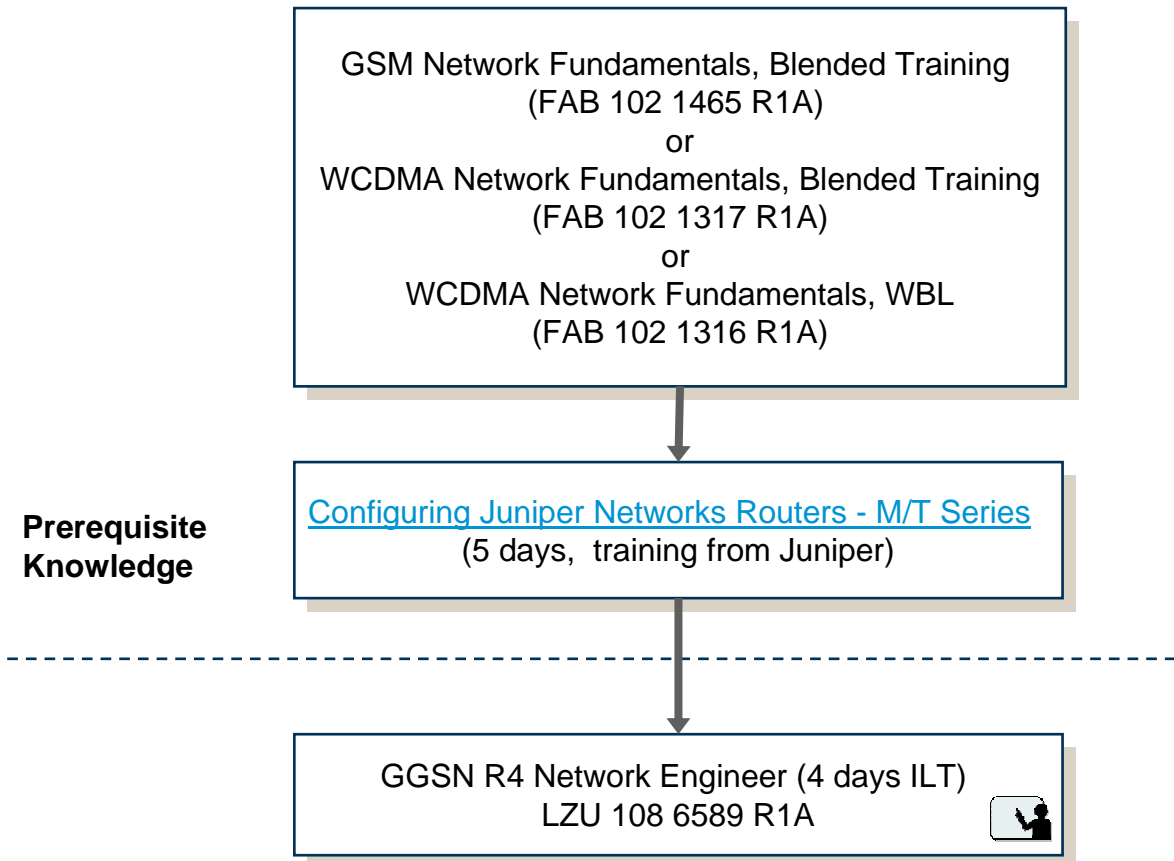

GSM R12 Core Network Advanced Configuration

(FAB 102 1898 R1A)

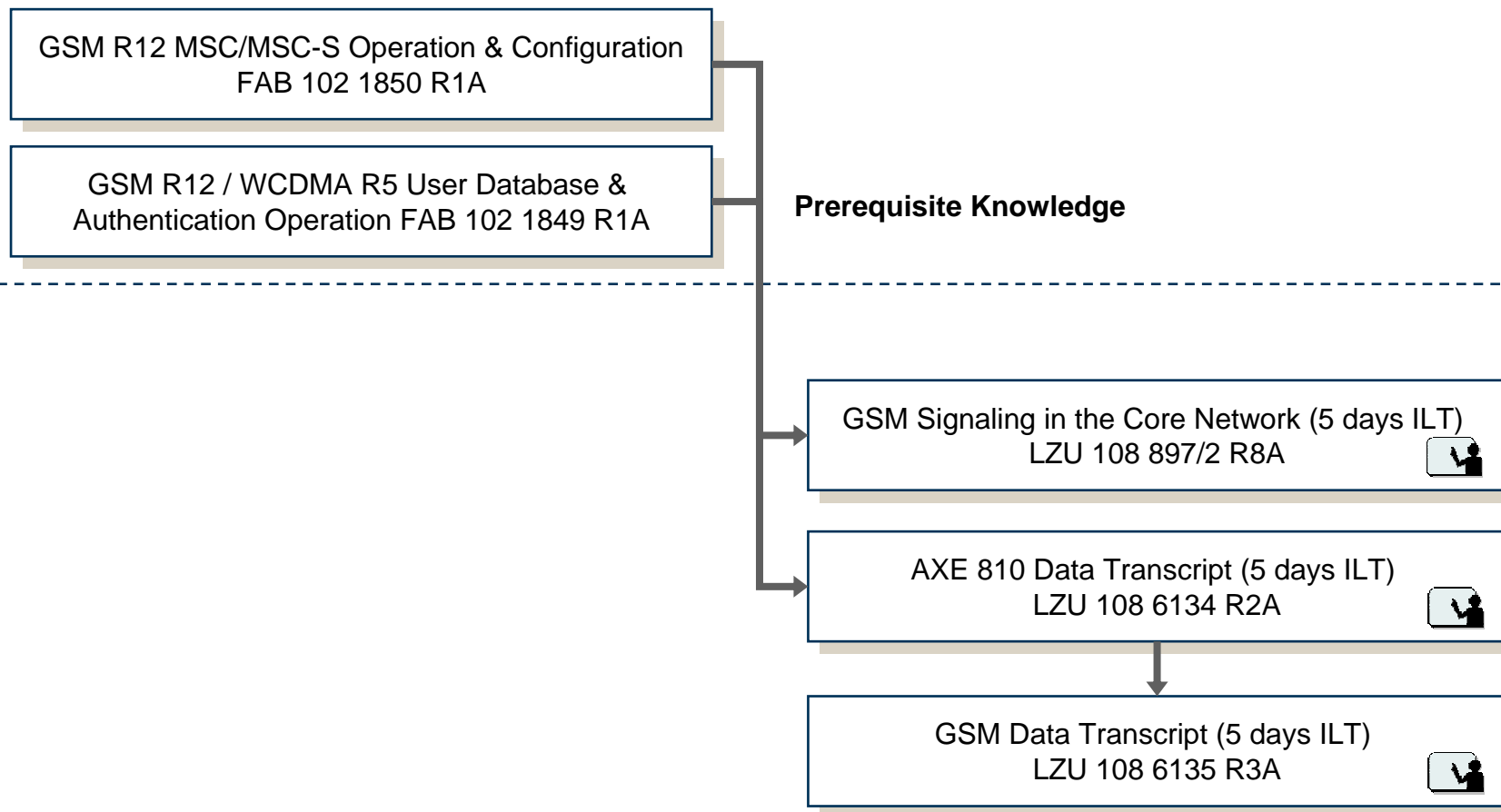

MSS R3.1 Configuration

(FAB 102 1858 R1A)

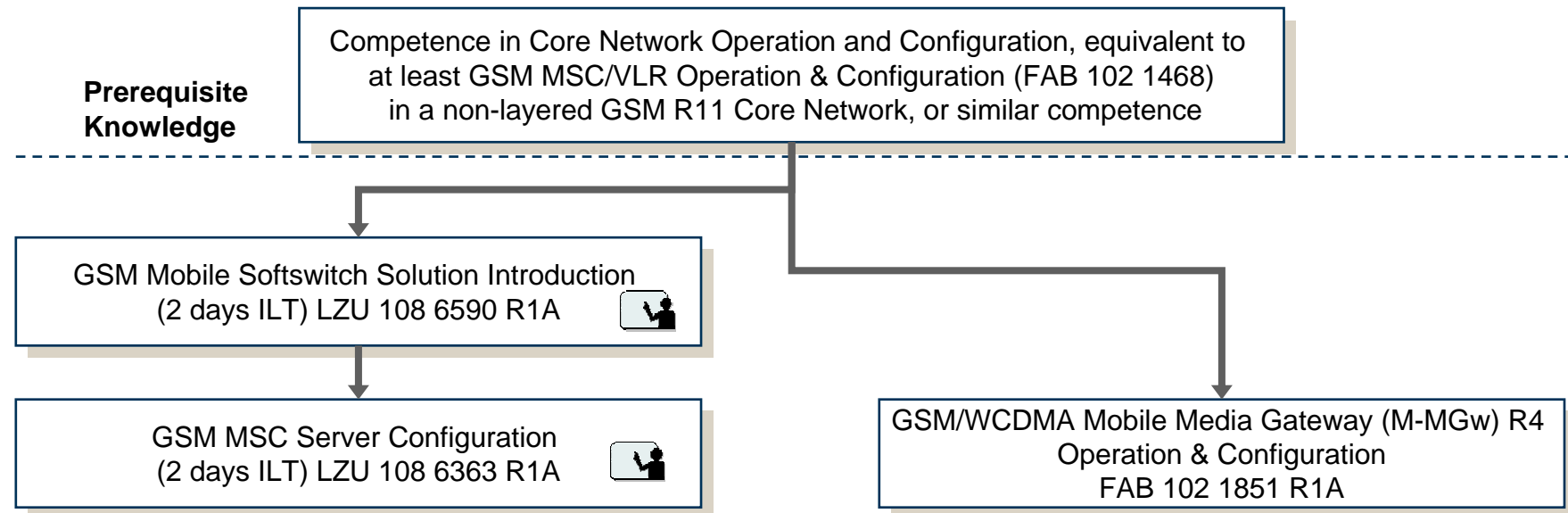

Mobile Softswitch Solution, hands-on training:

The integration or migration of a Core Network towards Mobile Softswitch Solution (Layered Architecture) comprises different target groups, depends on the setup of the organization, business goals and performance goals of the operator, and requires a variety of different competencies. Thus, no single course, covering all needs is offered for the hands-on training part. Ericsson Education offers Learning Solution for best fitting the different target groups' competence needs according to the operators' goals. For more information on the concept of Learning Solution, please refer to the following link:

http://www.ericsson.com/products/hp/Learning_Solutions_pos.shtml

MSS R4.0/R4.1 Configuration

(FAB 102 1859 R1A)

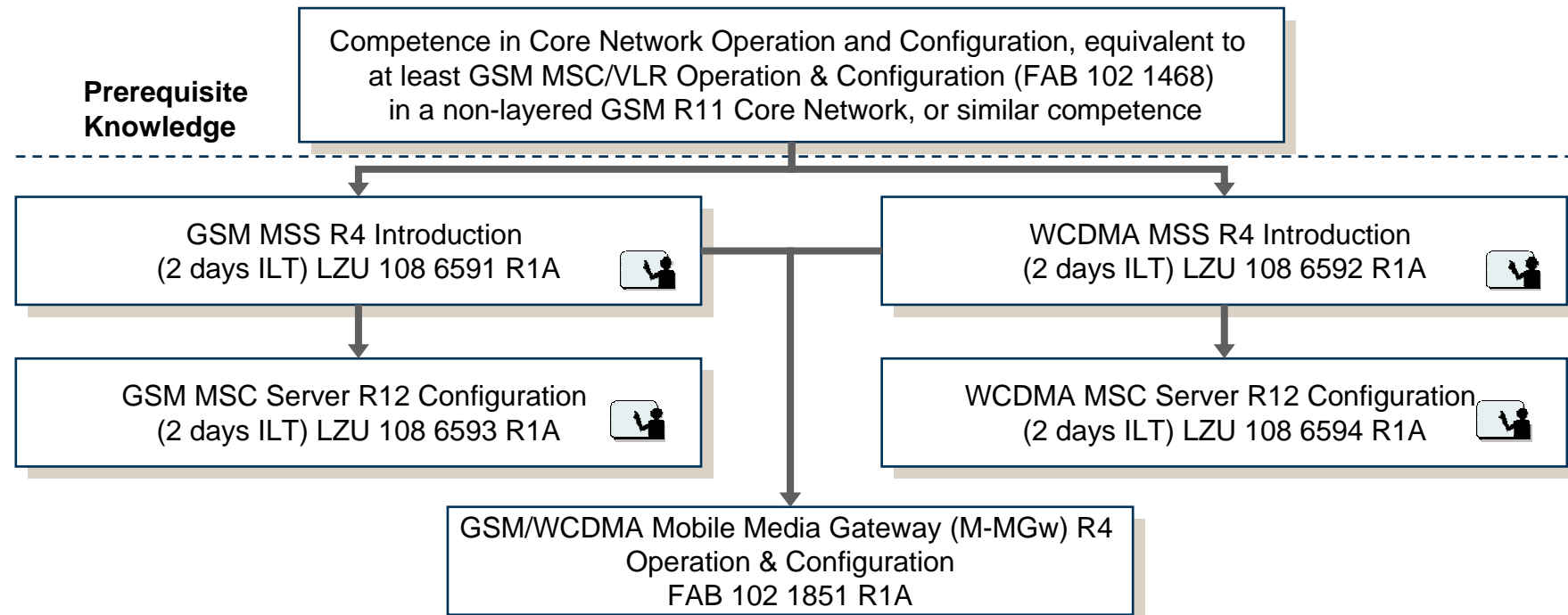

Mobile Softswitch Solution, hands-on training:

The integration or migration of a Core Network towards Mobile Softswitch Solution (Layered Architecture) comprises different target groups, depends on the setup of the organization, business goals and performance goals of the operator, and requires a variety of different competencies. Thus, no single course, covering all needs is offered for the hands-on training part. Ericsson Education offers Learning Solution for best fitting the different target groups' competence needs according to the operators' goals. For more information on the concept of Learning Solution, please refer to the following link:

http://www.ericsson.com/products/hp/Learning_Solutions_pos.shtml

GSM R12 End-to-End Feature Solutions (FAB 102 1899 R2A)

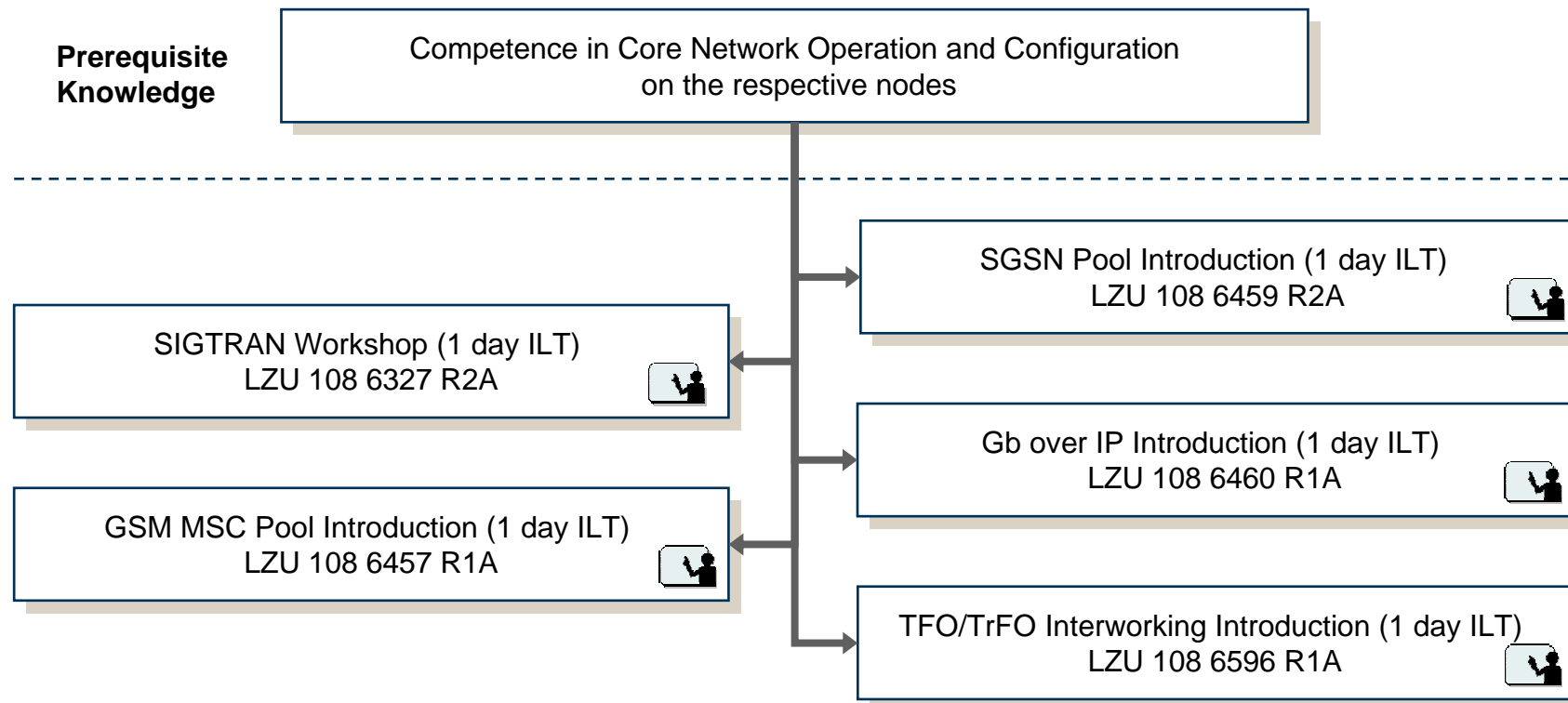

GSM R12 / WCDMA R5 Core Network Charging Operation

(FAB 102 1866 R1A)

Prerequisite Knowledge

GSM R12 MSC/MSC-S Operation & Configuration
FAB 102 1850 R1A Or
WCDMA R5 MSC/MSC-S Operation & Configuration
FAB 1021848 R1A

GSM/WCDMA SGSN R7 Operation
FAB 102 1852 R1A

GSM/WCDMA MSC R12 Charging Operation
(2 days ILT) LZU 108 6597 R1A 

GSM/WCDMA SGSN R7 Charging Operation
(0,5 days ILT) LZM 112 405 R1A 

GSM CORE NETWORK

- NETWORK DEVELOPMENT -

GSM R12 Core Network Statistics Handling

(FAB 102 1900 R1A)

Prerequisite Knowledge

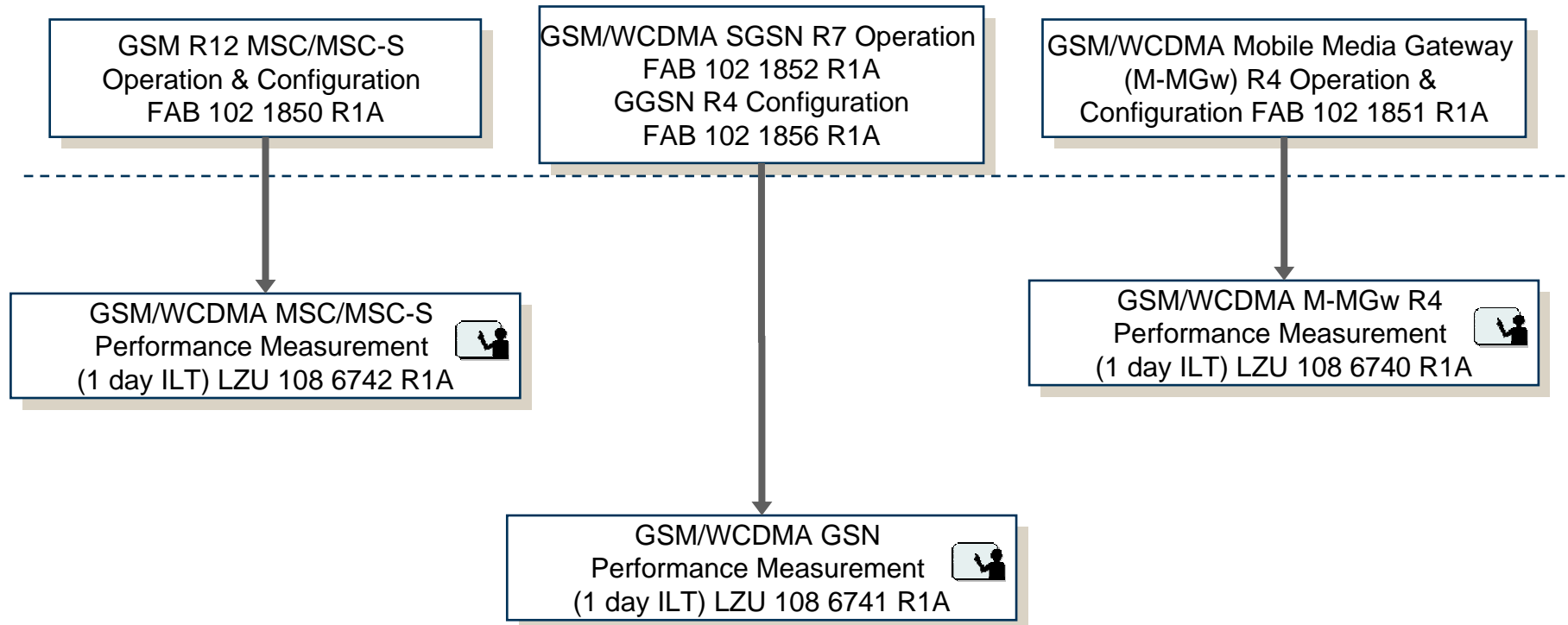

GSM R12 Core Network Planning

(FAB 102 1901 R1A)

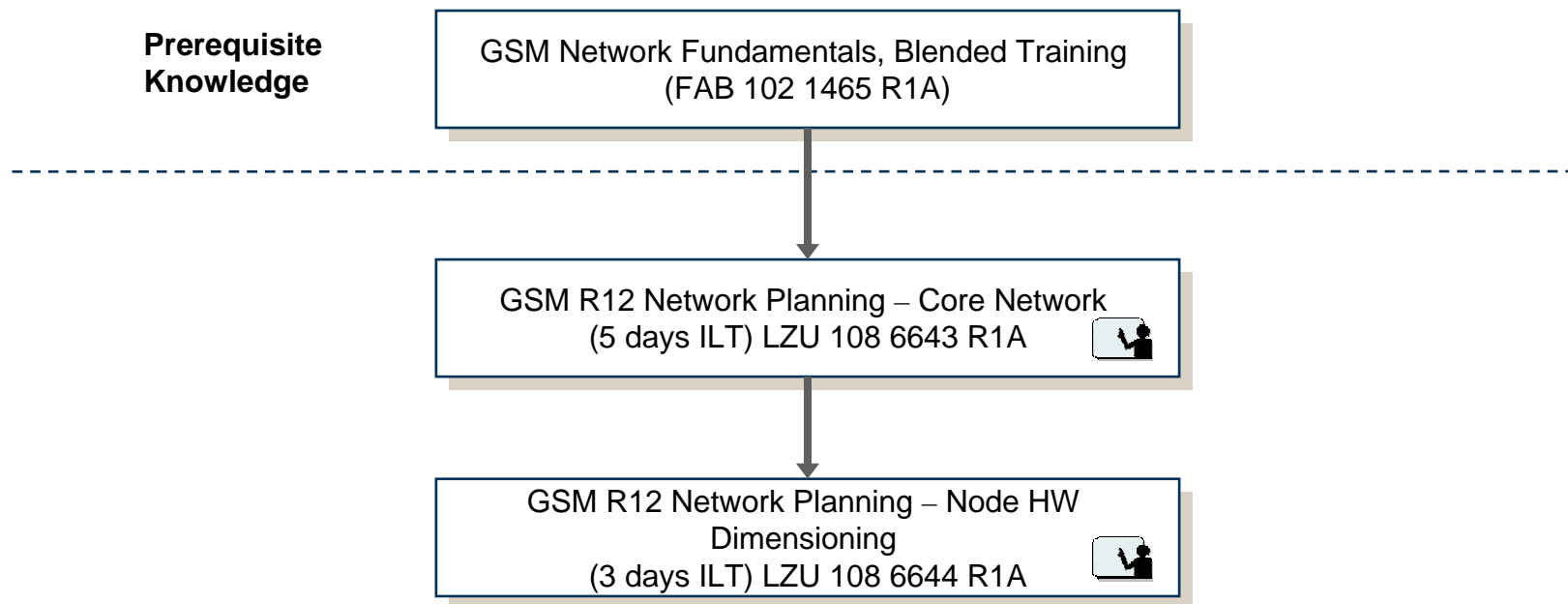

GSM TRANSPORT NETWORK

- NETWORK OPERATION AND CONFIGURATION-

AXD 301/305 Field Maintenance

(FAB 102 1341)

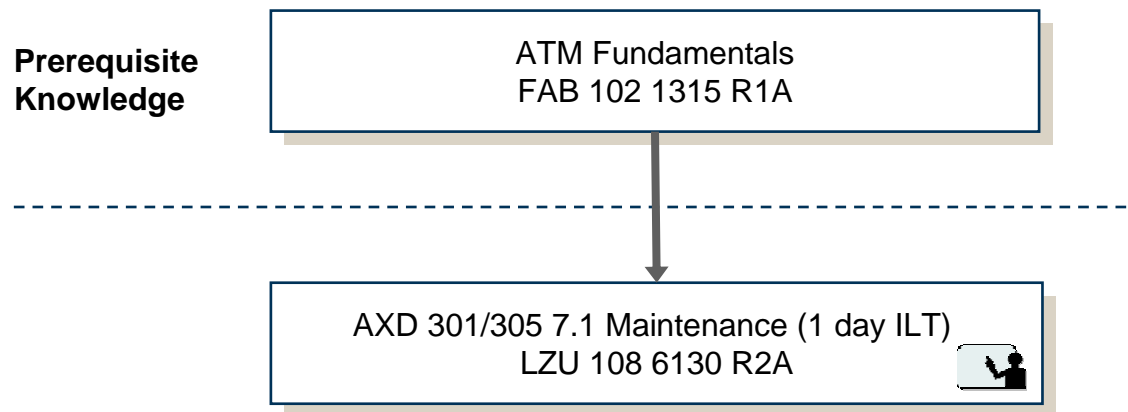

AXD 301/305 Network Operation & Configuration

(FAB 102 1342)

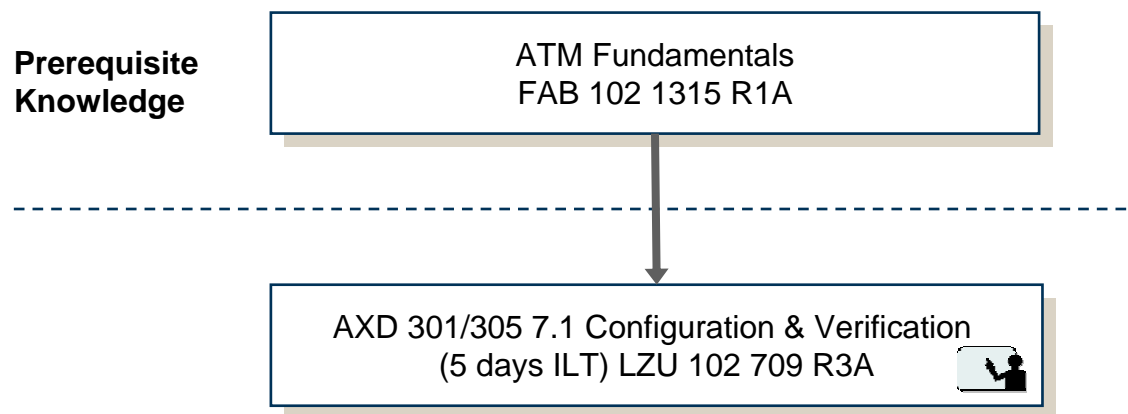

Related training packages

The following related training packages can be found at <http://www.ericsson.com/education/development/> :

- GSM RAN R12
 - WCDMA R5 Core Network
 - Ericsson IP Multi Media Subsystem (IMS) Solutions
 - Charging System 3.0
 - Mobile Packet Backbone Network (M-PBN)
 - Service Aware Charging and Control (SACC)
-
- The following Education Services can be found at http://www.ericsson.com/products/services/training/learning_solutions.shtml
 - Learning Solutions
 - Structured Knowledge Transfer (SKT)



Name

Position

Ericsson AB
Business Unit Global Services

Tel: + area code/ local number

Fax: + area code/ local number

Mob: +area code/ local number

e-mail: xxx.xxx@ericsson.com

www.ericsson.com/products/services/training.shtml

ERICSSON 

TAKING YOU FORWARD