



[ericsson.com/
microwave-outlook](https://ericsson.com/microwave-outlook)

Ericsson Microwave Outlook

October 2019

Enhancing 5G with microwave

To meet the rapid deployment of 5G around the globe, it is evident that a variety of transport solutions are required in order to fulfill the needs of communications service providers.

Contents

03	Handling the capacity evolution
05	The latest on spectrum
07	Lessons learned from a decade with E-band
10	Demystifying MIMO for microwave
13	Breaking the 100Gbps barrier

The international rollout of 5G is progressing much more quickly than anticipated and the necessity for high capacity backhaul and fronthaul has never been more apparent. Suburban and urban high capacity sites in 2022 will require capacities of up to 2 and 10Gbps respectively, while towards 2025 we will see examples of sites stretching between 5 and 20Gbps. Microwave is already well positioned to support all backhaul capacity needs using standalone E-band or multi-carrier solutions. In regards to fronthaul, microwave can act as a complement to fiber for antenna site capacities in a range of 10Gbps in 2019 and 25Gbps by 2022.

Now that commercial 5G services have gathered a strong global momentum, the dust settles on future spectrum use. Some backhaul frequency bands will eventually be transitioned to 5G access use, such as 26GHz in Europe. In contrast, the E-band and 32GHz band are acknowledged as essential for the backhaul of 5G. The solutions which are viable for each service provider and country are dictated by microwave spectrum availability, which in turn impacts both capacity and the total cost of ownership. In order to enable higher capacities in both traditional spectrum and E-band, access to wider bandwidths is important. Without this, more complex and spectrum-efficient solutions are required. MIMO is an important enabler for countries with limited spectrum availability to reach high capacity links of 1Gbps and beyond. By using MIMO and E-band radios,

Deutsche Telekom and Ericsson were able to smash the 100Gbps barrier during a trial in Athens, Greece. With optimal antenna arrangement, the trial achieved 139Gbps over 1.5km, with high availability and low latency. Such microwave links will be ideal as cost- and time-efficient complements to optical fiber for closure and redundancy of metro and core fiber rings, fiber extension applications, campus and enterprise connections and backups to existing high-capacity fiber links. As a result of technological developments, we expect that the first 100Gbps links will be deployed in 5 to 8 years, depending on the market demands.

After almost a decade of experience in commercial E-band deployment, we have gained a number of insights to assist in E-band's future usage. For example, we foresee an increased use of E-band for longer hops, even if that means accepting a slightly lower availability. The widespread use of E-band increasingly supports our prediction that E-band will account for 20 percent of all new microwave links by 2025.

It is evident that microwave is well prepared for the network evolution of 5G and beyond.

Key contributors

Executive Editor:	Git Sellin
Editor:	Maria Edberg
Articles:	Magnus Berggren, Jonas Edstam, Dennis Eriksson, Jonas Flodin, Jonas Hansryd, Andreas Olsson, Mikael Öhberg
Co-written article:	Dimitris Siomos (Deutsche Telekom)

Handling the capacity evolution

The 5G train is running faster than expected. The need for high capacity backhaul and fronthaul is becoming even more important and microwave is well positioned.

As seen in the June 2019 edition of the [Ericsson Mobility Report](#), the 5G rollout is happening quicker than expected. The LTE and 5G New Radio (5G NR) expansion will continue in terms of both capacity and coverage. LTE coverage will reach 90 percent and 5G coverage 45–65 percent (depending on deployments in the existing LTE band) by 2024 across the globe.

The increase in backhaul capacity per site when introducing 5G NR depends on several considerations, such as technology (e.g. MU-MIMO), 5G NR spectrum (low, mid and high band) and potential underlying small cells within its coverage area. The upper table in Figure 1 is a forecast of the backhaul capacity per site, with the predictions for 2022 and towards 2025 that support the rollout of 5G NR. The figures for 2019 show a slight increase for both urban sites and suburban high capacity sites due to LTE capacity upgrades in the networks. The low capacity figures represent around 80 percent of all sites, while the high capacity figures represent only a small percentage. Suburban and urban high-capacity sites in 2022 will require capacities up to 2 and 10Gbps respectively, while towards 2025, we will see examples of sites stretching between 5 and 20Gbps respectively. Microwave is well positioned and can already today support all these capacity scenarios, using standalone E-band or multi-carrier solutions within the band and/or across several bands, such as E-band in combination with 18GHz.

Fronthaul is the connection between the digital unit and the antenna, which are the Common Public Radio Interface (CPRI) and evolved CPRI (eCPRI) interfaces, as seen in Figure 2. These interfaces require higher bandwidths and very low latency compared to Next Generation (NG) or F1 interfaces. Microwave is a complementary technology for fronthaul, when fiber is not a viable solution.

Figure 1: Capacity forecast

Backhaul capacity per site

	2019 Low – high cap. sites	2022 Low – high cap. sites	Towards 2025 Low – high cap. sites
Urban	250Mbps – 2Gbps	450Mbps – 10Gbps	600Mbps – 20Gbps
Suburban	100Mbps – 500Mbps	200Mbps – 2Gbps	300Mbps – 5Gbps
Rural	50Mbps – 150Mbps	75Mbps – 350Mbps	100Mbps – 600Mbps

Fronthaul capacity per site

	2019	2022	Towards 2025
Antenna site	up to 10Gbps	up to 25Gbps	up to 100Gbps

Source: Ericsson (2019)

The capacity per antenna site is the capacity of the connection to the digital unit, either on the same site or at a C-RAN site. An antenna site can also be an offshoot from a D-RAN site, typically as a small cell or street macro deployment. Microwave can be used at the antenna site when capacities are in the range of 10Gbps in 2019 and 25Gbps towards 2022. The introduction of eCPRI will enable the use of standard packet E-band radios. E-band can already support low capacity antenna sites, with the potential to reach beyond 100Gbps in the future; other fronthaul use cases might also be applicable.

Figure 2: Simplified RAN architecture

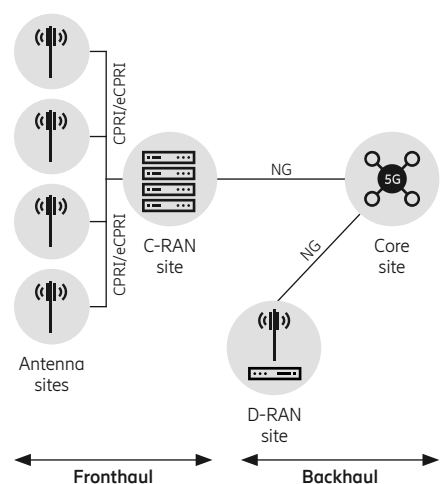
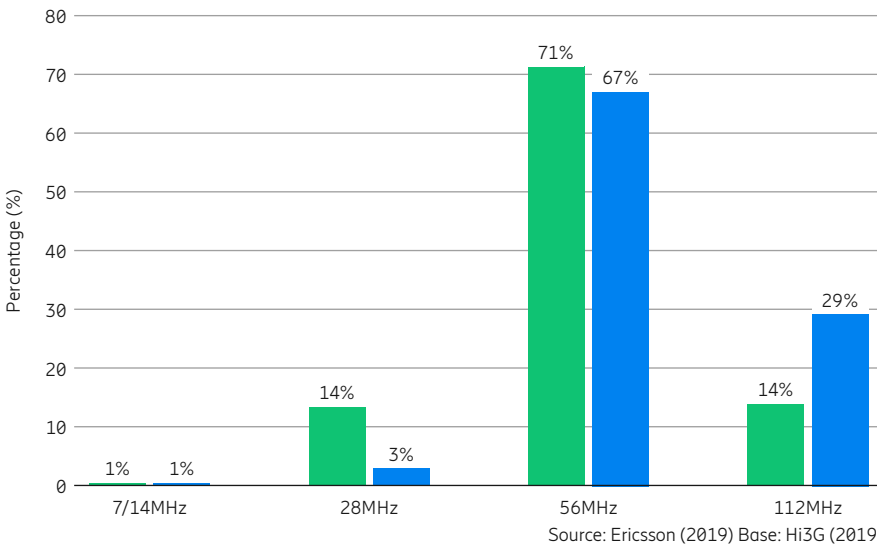

Figure 1 states the expected future capacities, but it is important that we know how service providers are currently handling the capacity evolution with microwave links. We have examined two very different regions – the Scandinavian countries and India. As a Scandinavian service provider exemplified by Hi3G in this paper, both traditional bands

(6, 7, 8, 10, 11, 13, 15, 18, 23, 26, 28, 32, 38 and 42GHz) and E-band are available, while in India, only 7, 13, 15, 18 and 23GHz can be used. Moreover, in Sweden, link-by-link licensing is normally used (with a few exceptions) for both traditional bands and E-band, while service providers only pay a small fee per carrier, irrespective of the frequency band or channel bandwidth.

In Denmark, traditional bands and E-band are link-by-link and the spectrum fee is proportional to the channel bandwidth. In India the spectrum is block licensed per circle, per 28MHz channel. All these differences result in totally different strategies and solutions for microwave links in their networks.

Figure 3: How a Scandinavian service provider expands capacity in traditional bands



Traditional frequencies available in Scandinavian countries: 6, 7, 8, 10, 11, 13, 15, 18, 23, 26, 28, 32, 38 and 42GHz

~30%

The share of links using 112MHz has doubled in one year to 30 percent.

Figure 3 shows a clear trend in Scandinavian countries when comparing 2018 with 2019. Moving from narrow channels to 112MHz channels, with or without XPIC, means a migration to more than 1Gbps using one or two carriers on traditional bands. For this particular Scandinavian service provider, 29 percent of all traditional links are 112MHz in 2019. Combined with the introduction of E-band links in their network,

as seen in Figure 4, we can see that 70 percent of E-band links are designed for 3Gbps or more. By comparing the E-band strategies of Sweden and Denmark, there is a majority of 250 and 500MHz links for Denmark, with wider channels for Sweden. This is largely due to the different spectrum fee strategies in each country.

In comparison, an Indian service provider only has a few bands to use

and only 28MHz channels. They need to use multi-carrier solutions to meet high capacity links of 1Gbps and beyond, which means more complex site solutions, such as quadruple carriers and using MIMO.

It is evident that the spectrum and availability of wider channels, including E-band, simplifies the migration towards increased capacity in a network with single carrier and dual carrier multi-band solutions.

Figure 4: A Scandinavian service provider expanding capacity with E-band

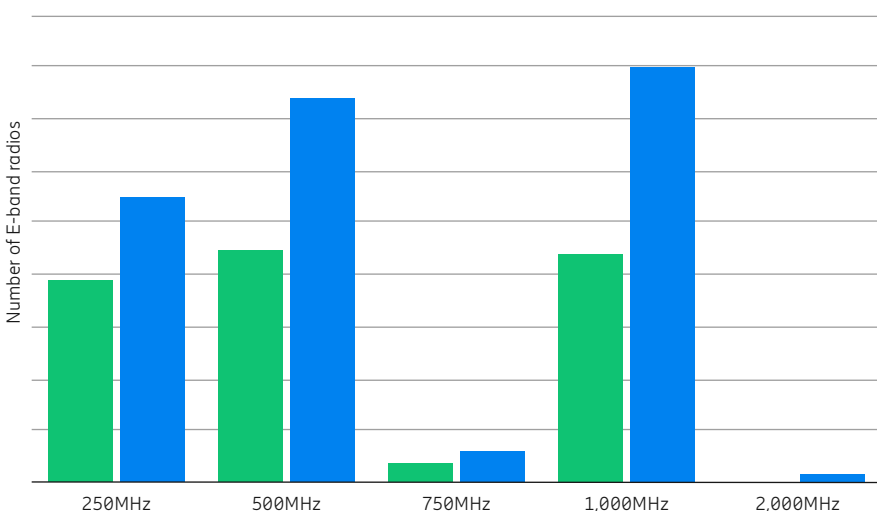

Number of E-band hops increased by 64 percent from 2018 to 2019.

≥ 3Gbps

There is 3Gbps or greater capability in more than 70 percent of E-band links.

Source: Ericsson (2019) Base: Hi3G (2019)

The latest on spectrum

With the strong global momentum for commercial 5G services, the dust settles on future spectrum use. Some backhaul frequency bands will transition to 5G access use, while E-band and 32GHz band are essential for the backhaul of 5G.

In country after country, 5G networks are being switched on and by 2024 they are expected to carry 35 percent of the global mobile data traffic.¹

New spectrum in high, mid and low frequency bands are being planned and awarded in an ever-increasing number of nations. Subsets of the new bands are often made available on a national level, to stepwise transition existing users (such as satellite, broadcasters, fixed wireless or others) from the band. In addition, all 3GPP bands in use for current mobile generations will eventually be considered for 5G services. An even faster rollout of 5G coverage can be supported by deployments of 5G in the same spectrum as 4G, enabled by a technological advancement known as spectrum sharing.

Microwave backhaul is used extensively in many frequency bands above 6GHz

and will remain an essential transport medium for 5G. Some of these bands will increase in backhaul use, while others will eventually transition to 5G NR access. The timing of the transition will vary, as the best use of each band will change over time in different countries. In addition to the 5G spectrum plans of pioneering countries, the International Telecommunication Union's (ITU) World Radiocommunication Conference (WRC-19) in November 2019 will identify which bands in the 24–86GHz range suit 5G.

The US takes the lead in high band 5G

The ranges 24.25–29.5GHz and 37–43.5GHz are specified by 3GPP for 5G NR. The United States is leading the efforts on 5G NR use in high bands, with 4GHz of total bandwidth being released

in the 24, 28, 37 and 39GHz bands. Other leading countries are Korea, which has released 2.4GHz in the 28GHz band, and Japan, which has released 1.6GHz in the 28GHz band. In Europe, the 26GHz band (24.25–27.5GHz) is the pioneering high band, with some countries expected to release a 1GHz subset as a first phase.

Europe is also interested in the 42GHz band, since the 38GHz band is too heavily used for microwave backhaul and also intended for satellite use. Work to harmonize the 42GHz band for 5G is expected to start immediately after WRC-19. China has indicated interest in the 24.75–27.5GHz band and the 37–43.5GHz range. A global overview of decisions and indications for the 26 and 28GHz bands is shown in Figure 5.

Figure 5: 26 and 28GHz bands being decided or considered for 5G NR

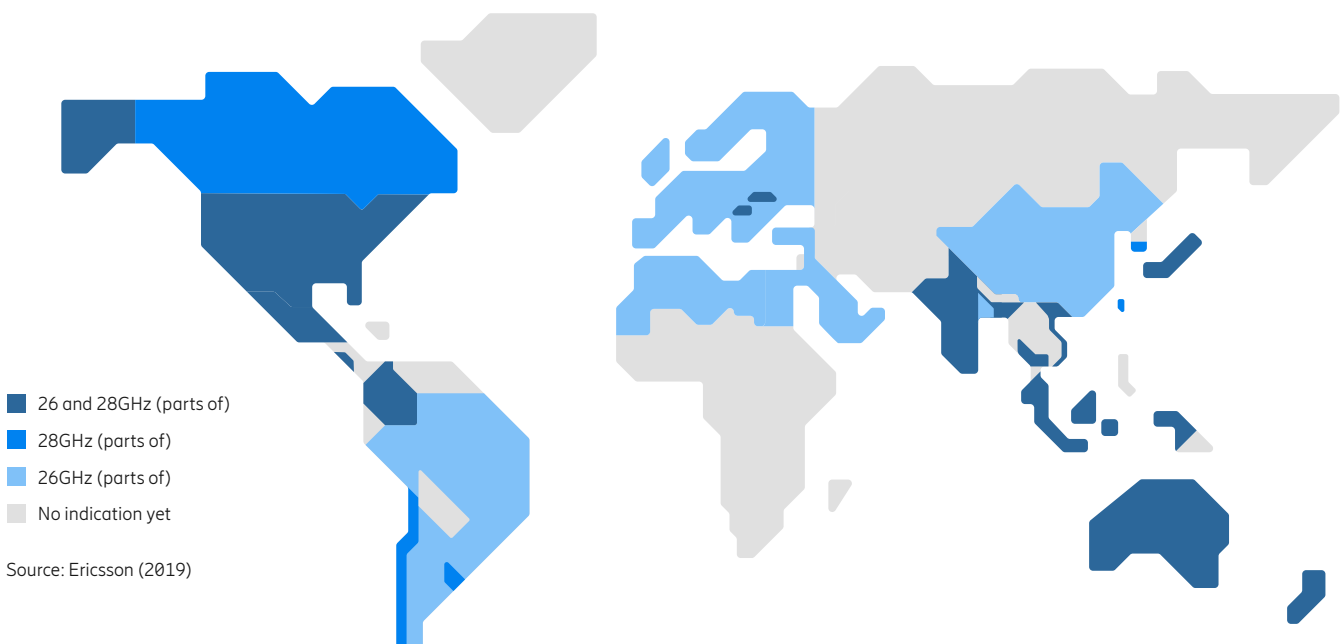

¹Ericsson Mobility Report (June 2019): www.ericsson.com/en/mobility-report

Figure 6: The momentum of E-band backhaul



France

5 percent of all hops
1.8km average distance

Source: Ericsson (2019)

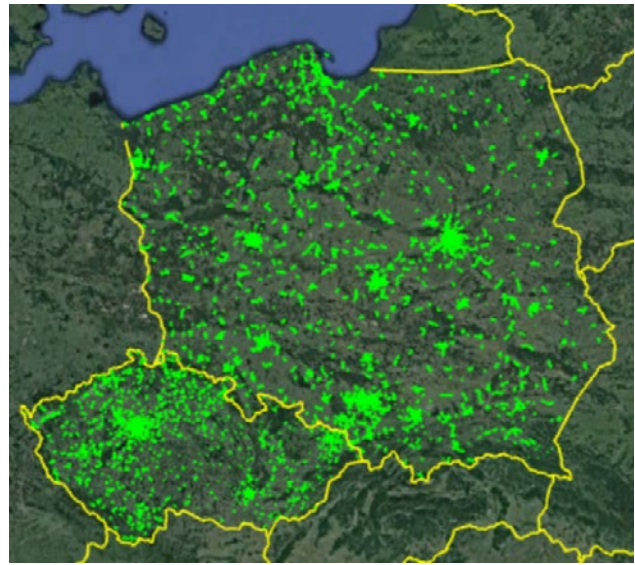

Czech Republic

20 percent of all hops
1.6km average distance

Poland

20 percent of all hops
2.8km average distance

— E-band hops

Essential frequency bands for backhaul

The E-band (71–76GHz paired with 81–86GHz) is becoming an essential backhaul band of high global alignment. Its use has grown rapidly over the last couple of years, especially in countries with an attractive spectrum license fee. For example, in Poland and the Czech Republic, about 20 percent of all hops are now in E-band (Figure 6). In preparation for 5G, transport networks will be upgraded to support higher capacities. Fiber penetration will increase, and the E-band is the widely recognized frequency choice for 5G transport in urban and suburban areas. This will facilitate the transition of backhaul from bands now being designated for 5G NR use, such as 26GHz in Europe. The E-band has been studied for 5G NR access use, but this no longer has any support. However, it has been acknowledged as essential for backhaul use. The 32GHz band (31.8–33.4GHz) has also been deemed unsuitable for 5G NR, and instead it is a strong candidate to become a global backhaul band.

E-band and 32GHz band are acknowledged as essential for the backhaul of 5G.

Scattered view and use of the 60GHz band

The backhaul usage in the 57–66GHz band is very limited. The band's status has been immature, with subsets licensed for backhaul in some countries, while in other countries it is designated for license-exempt technology agnostic use. The whole band is unlicensed in the United States, with rules to limit the probability of interference for wireless configurations with everything from omni to high directivity antennas. In Europe, the rules were changed in June 2019 to allow similar license-exempt use as the United States. These rules are expected to keep the probability of interference between applications low. However, high reliability usage is not recommended, as high quality cannot be guaranteed in license-exempt bands.

The 66–71GHz range has been studied for 5G ahead of the WRC-19 and is generally seen as well suited. However, there are some different national and regional opinions on the licensing and use of the band. For example, 64–71GHz was added to form a 57–71GHz band for unlicensed use in the United States. In Europe, there is desire that the 66–71GHz band, while supported for 5G, should also be made available for other wireless access technologies on an equal basis. 3GPP is expected to specify 5G NR for the 57–71GHz band in a few years.

The 6–24GHz range, an asset for the future

Looking to the future, discussions have now started on new 5G bands in the 6–24GHz range. For example, China is planning to study the 6GHz band for licensed 5G. Frequency bands below 10GHz are essential for long-range backhaul. However, these are sparsely deployed and, as a result, there is locally unused spectrum. The opportunity to introduce license-exempt, technology neutral, wireless access is being studied in both the United States and Europe for parts of the 6GHz band, with the requirement that there is no harmful interference for backhaul use. 3GPP also specifies the 6GHz band for unlicensed NR.

Spectrum is a finite resource and more efficient use will be needed in the future. There are large variations in the use of backhaul bands in different locations, countries and regions, depending on the demand and the most valuable use of spectrum in each location. In the future, we will see some nations decide to use a band for 5G NR, while others use it for backhaul. Some countries might even decide to use a band for 5G NR in urban areas, but for backhaul in rural areas.

Although the use of microwave backhaul is increasing globally, the need for much more bandwidth per hop is the main spectrum challenge. Wide frequency bands supporting short, mid and long-range backhaul are essential, along with continued technological innovations. The possibility to use more spectrum by sharing it with other radio services could also be a future opportunity.

Lessons learned from a decade with E-band

E-band is increasing in importance with the arrival of 5G and its demand for high capacity. During the recent years of commercial deployment, a number of insights have been gained that will facilitate the future use of E-band.

Many operators are facing a need to update their backhaul network to meet the capacity requirements of a 5G rollout. The RAN capacities in a 5G network, especially in urban/suburban environments, increase the need for backhaul equipment capable of handling multi-gigabit traffic in a cost-efficient way. With limited spectrum in the traditional frequency bands, the attention directed towards E-band is

constantly increasing. The technology has been successfully proven in several countries for a number of years and will increasingly be needed to boost capacity in urban sites, along with multi-band booster (MBB) combinations in suburban sites. As can be seen in Figure 7, the momentum of E-band is in full swing. In 2018 there were 14 times more E-band radios sold globally compared to 2011.

As the worldwide 5G rollout drives the need for cost-efficient backhaul capacity and E-band becomes available in more countries, the curve is expected to become even steeper. With this continued growth in mind, 20 percent of new deployments are estimated to be E-band by 2025.

From a decade of both standalone and multi-band E-band deployment, there are three main lessons to be drawn.

Figure 7: Growth of E-band radios from 2010–2018 and predicted for 2019–2025

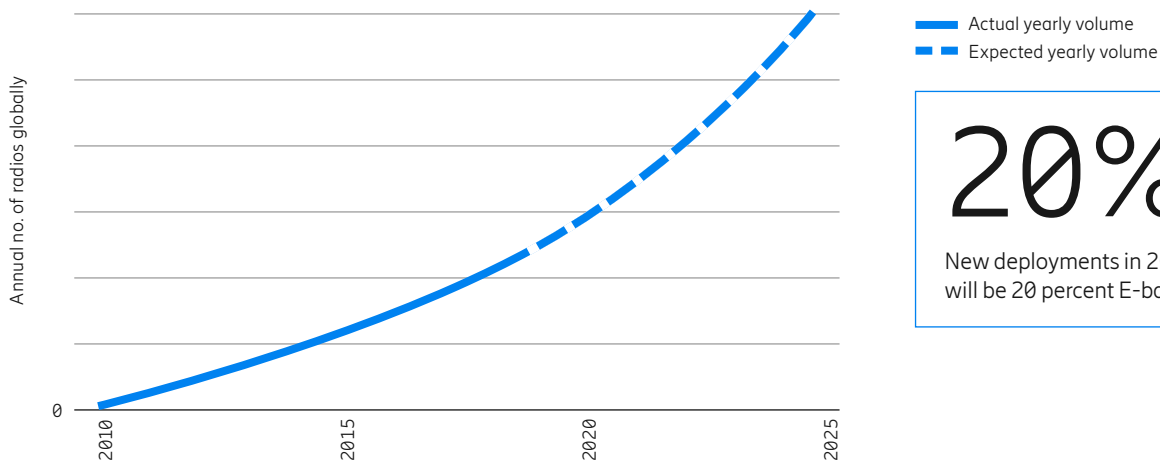

— Actual yearly volume
 - - - Expected yearly volume

20%
 New deployments in 2025 will be 20 percent E-band.

Source: Ericsson (2019)

1. Reality matching predicted availability

For deployment of E-band radios in a network, the MBB concept is one of the key strategies. The obvious benefits are that it increases the capacity of an existing hop or stretches the hop length of the E-band. The trade-off in all of this is the availability of the E-band.

Figure 8 shows the availabilities for an 18GHz radio and an E-band radio, measured over 12 months in Gothenburg,

Sweden (Rain zone E, ITU-R 837-1). The hop is a 7km long MBB configuration, using a combination of an 18GHz radio with a 28MHz channel and an E-band radio with a 125MHz channel. The 18GHz radio had consistent traffic during the 12-month period and the E-band radio remained at maximum modulation and capacity for more than 98 percent of the time. The E-band link contributed to the total capacity 99.93 percent of the time.

When using an E-band radio with a 500MHz channel, the corresponding values for the E-band’s maximum modulation are just short of 98 percent, and the E-band is contributing close to 99.83 percent of the time. From a capacity perspective, it means that the hop never drops below 175Mbps and 99.93/99.83 percent of the time the E-band kicks in and boosts the hop with up to 17 times the capacity.

Figure 8: Availability and performance for a multi-band booster hop measured over 12 months

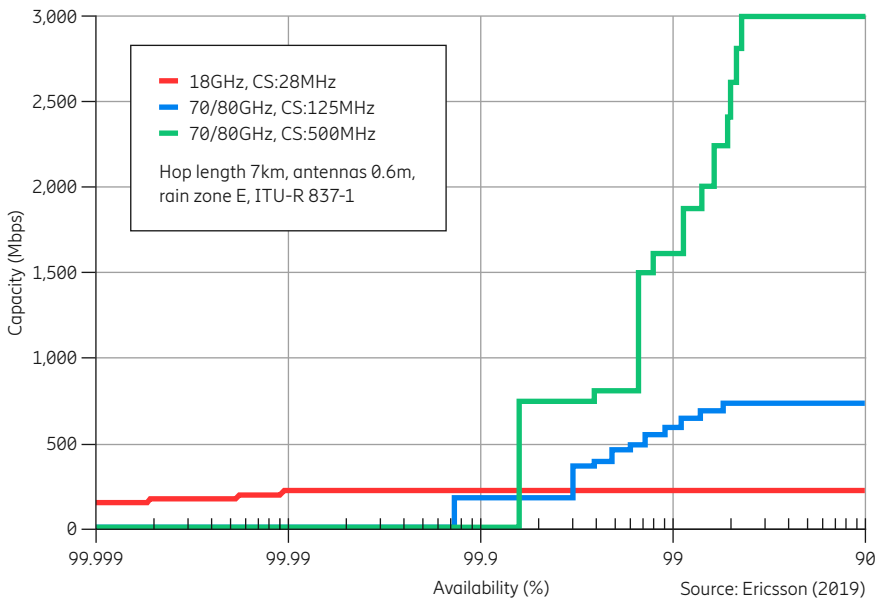

>99.9%

The E-band link contributed to the total capacity 99.93 percent of the time when the hop length is at 7km.

2. Longer hops win over high availability

One perceived drawback of any E-band deployment has been the idea of big limitations when it comes to hop length: that it is only applicable for one, maybe two kilometers. In Poland, where E-band penetration now exceeds 20 percent (as of May 2019), the service providers have chosen a method which allows for very long E-band hops. This distribution of hop lengths can be seen in Figure 9. Hops that are between 2 and 5km stand for 22 percent of the total, and as many as

11 percent of the hops are 6km or longer. In fact, 154 hops are 10km or even longer.

The distances where standalone E-band is used and where MBB hops begin to be introduced varies between service providers. Some start to deploy MBB at 3.5km and some wait until the distance is as long as 5km. The way to do this is to adjust the availability requirements of the E-band, in both standalone and MBB configurations.

Figure 10 shows 7 lengthy live hops, ranging from 4.1 to 12km in length (note: all are in different locations in

Poland with different rain intensity and vendor equipment) and the corresponding availability figures achieved for each modulation. By stepping away from the historical requirement of ‘five nines’, these impressive lengths have been achieved.

It is evident that E-band is a more viable solution for longer hops than previously expected and that Polish service providers have started to move towards a more packet-based approach to network planning, thus expanding the use of E-band radios.

Figure 9: E-band microwave hops deployed in Poland, split by distance

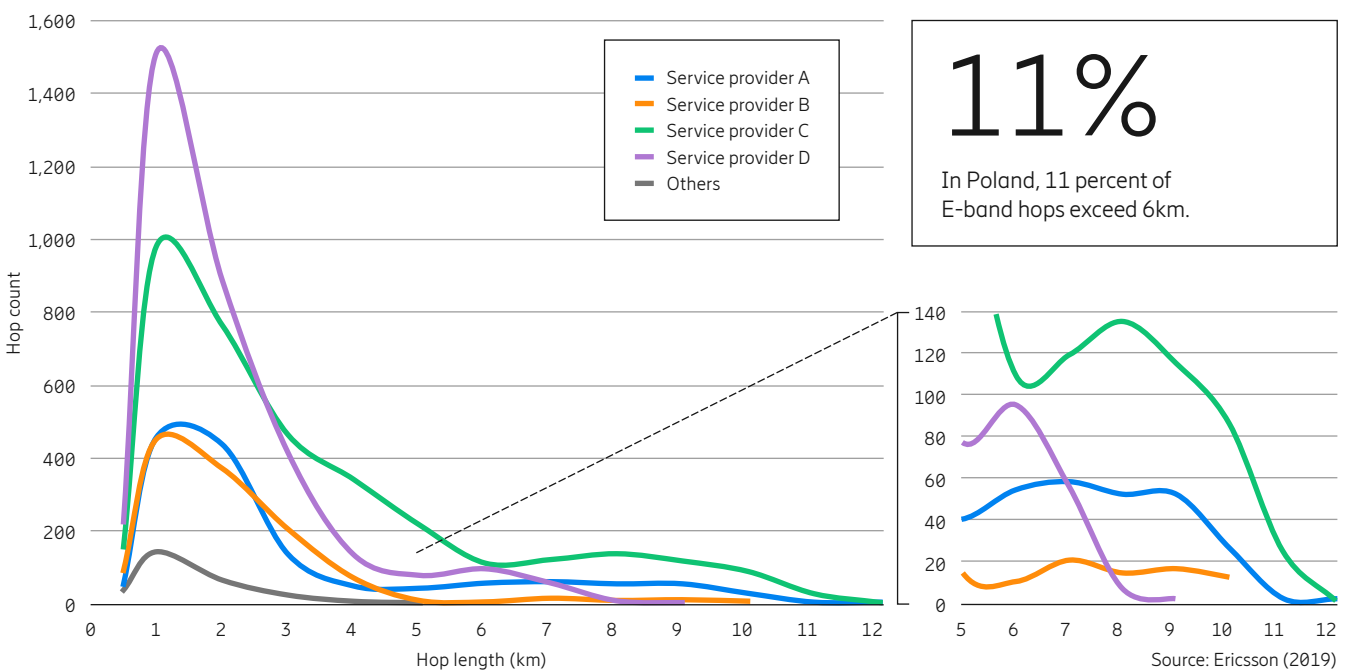

11%

In Poland, 11 percent of E-band hops exceed 6km.

Figure 10: Live data for multi-band booster E-band hops in Poland, availability for various modulations

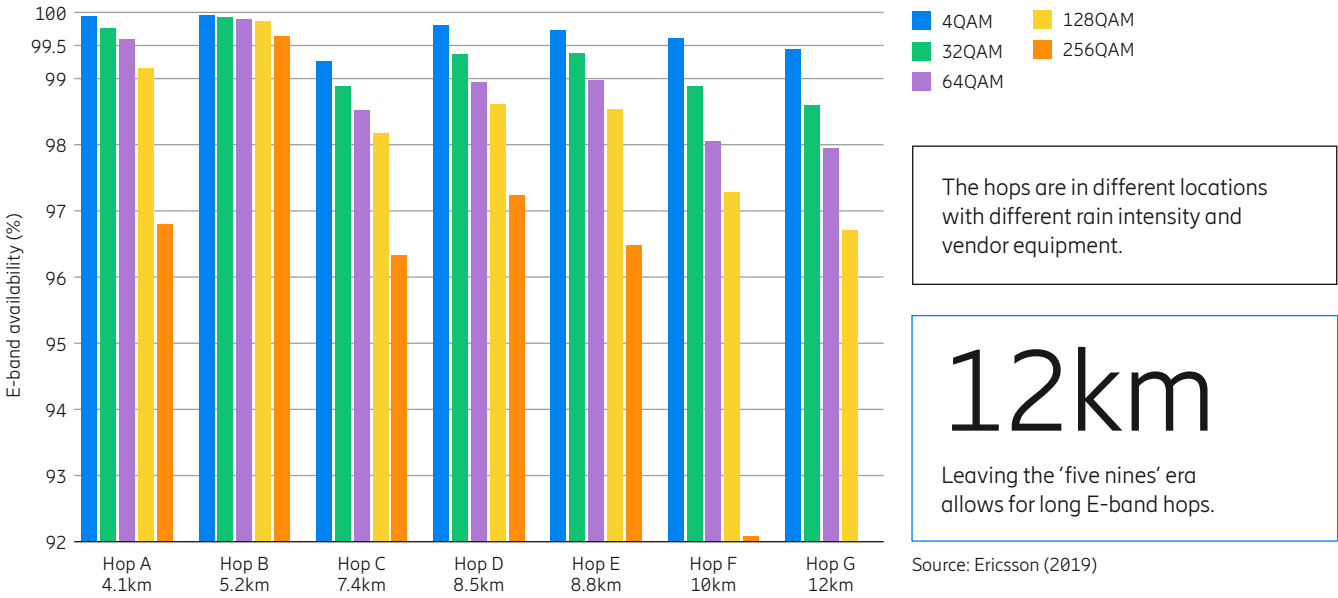

3. Accurate alignment is growing in importance

Point-to-point microwave links use high-gain antennas in the 30 to 50dBi range, corresponding to a half-power beamwidth (HPBW) of 5 and 0.5deg respectively. The lower gain limit is set by interference and frequency reuse, while the upper limit is set by practical limitations on alignment and stability. The gain distribution in different frequency ranges can be found in Figure 11. In the traditional bands (between 6 and 42GHz) the average gain distribution is in the 37 to 41dBi range, with the bulk well below 45dBi. Millions of such antennas have been installed. Only a small percentage of the installations have used very high gain antennas close to the upper 50dBi limit. It is understood

that extra attention and skilled installers have been needed on a few links. With the introduction of E-band, the distribution looks very different, with most links having an antenna gain above 45dBi (HPBW 1deg) and with an average as high as 48dBi. This means alignment skills are needed on many more links and the importance of stable masts also becomes more apparent. The main reasons for the high share of very high gain antennas in E-band are:

- Many E-band links deployed so far have replaced an existing link in a traditional band to save spectrum cost. With a pre-defined hop length, the gain needs to be maximized in order to minimize the impact on availability at the higher frequency.

- The same gain can be achieved with half the antenna diameter when the frequency is doubled. With an antenna as small as 0.6m in diameter a gain of 50dBi can be achieved at E-band. This is the most popular size in traditional bands, and is consequently being selected also for E-band.
- The regulations in some markets require a relatively high minimum gain.

In a future with denser networks and shorter hops, along with increased radio output power, the E-band average gain will go down. This will simplify those types of installations. On the other hand, E-band will also be used for even longer hops than today. If the gain increases beyond 50dBi then self-alignment and mast sway compensation will be mandatory.

Figure 11: Antenna gain distribution per frequency range, deployments 2014–2018

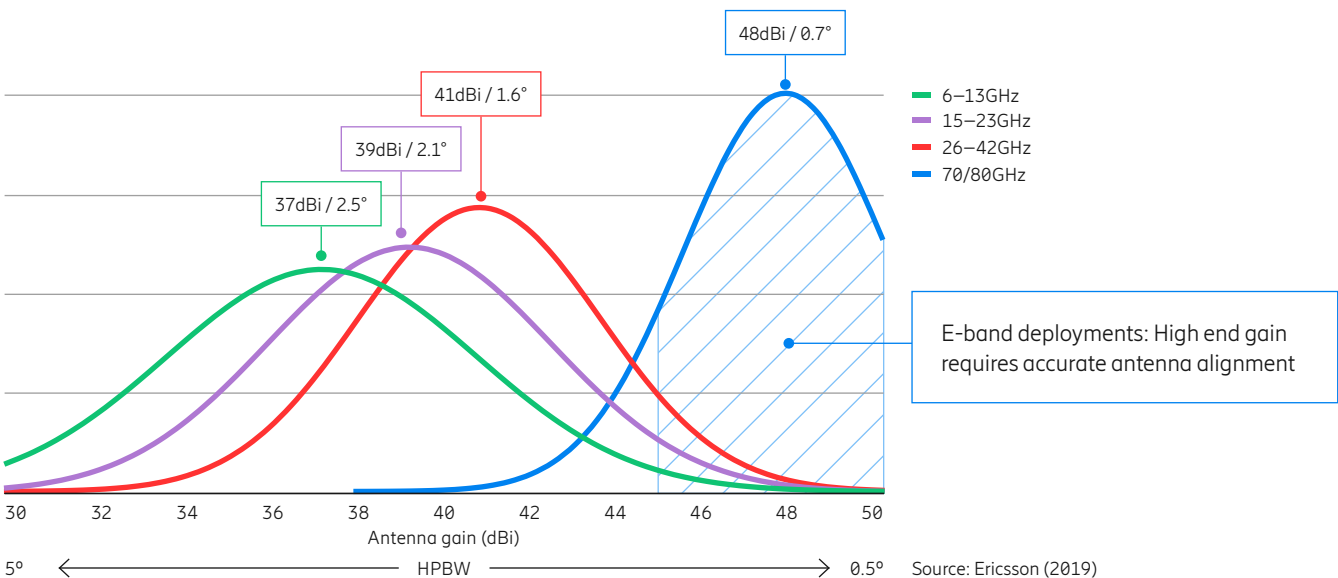

Demystifying MIMO for microwave

MIMO is an attractive solution for increasing spectral efficiency when spectrum is a scarce resource. It is instrumental for future implementations of 100Gbps over microwave. However, there are many things to consider in order to reach the optimal MIMO installation.

Multiple-Input Multiple-Output (MIMO) is a well-established antenna technology for enhancing spectral efficiency and/or reliability in wireless communication, and is being successfully used in 3GPP and Wi-Fi technologies. In a MIMO system, multiple antennas are deployed at both the transmitter and receiver side of a link. The multiple antennas can be used for either: 1) increasing the spectral efficiency (bps/Hz – bits per second and Hz) of the link by transmitting multiple data streams over the channel (also called spatial multiplexing) or 2) increasing the reliability of the link by exploiting the diversity gain introduced by the use of multiple antennas (also called spatial diversity).

A MIMO channel can be decomposed into multiple Single-Input Single-Output (SISO) channels over the same time and frequency. These channels are sometimes referred to as sub-channels of the overall MIMO channel. It is the use of these sub-channels in parallel over the same time and frequency channel that provides spatial multiplexing in MIMO.

For example, a properly designed MIMO system with 8 transmit and 8 receive antennas (8x8 MIMO) will have 8 sub-channels for spatial multiplexing. In other words, the 8x8 system will have up to 8 times the capacity of a single antenna system. For example, assuming that 6 bits per data symbol (64 QAM) is used in an 8x8 MIMO system over an E-band signal bandwidth of 2.25GHz – the overall rate will be 6 (bits per symbol) x 8 (data streams) x 2.25 (GHz) = 108Gbps. Through this, MIMO acts as an enabler for reaching 100Gbps and beyond.

In general, there is a trade-off between spatial multiplexing and diversity gain, meaning that one typically chooses which to prioritize. For example, in microwave long-haul links, spatial diversity receivers are commonly used to combat multipath fading, therefore offering protection to critical backhaul links. In a spatial diversity system, the data information is conveyed over different sub-channels, which increases the link protection as it is unlikely that all

sub-channels will fade at the same time. This also means that a spatial diversity system typically has increased availability of a certain data rate compared to a non-diversity system. In contrast to spatial diversity, a spatial multiplexing system instead uses all of the sub-channels to transmit multiple data streams in order to increase the spectral efficiency of the link. High spectral efficiency is important when spectrum is a scarce resource, which makes MIMO an attractive solution.

Principles of MIMO for microwave

The main intention in utilizing MIMO is in relation to multiple stream transmissions, in order to further enhance the spectral efficiency in microwave links. Spectral efficiency is enhanced by up to N times compared to a SISO system, where N is the MIMO order, limited by the number of antennas used in the MIMO system. In MIMO systems, it is possible to deploy any number of transmit and receive antennas, but a symmetric system is the most common,

Figure 12: MIMO for microwave transmission – the principle

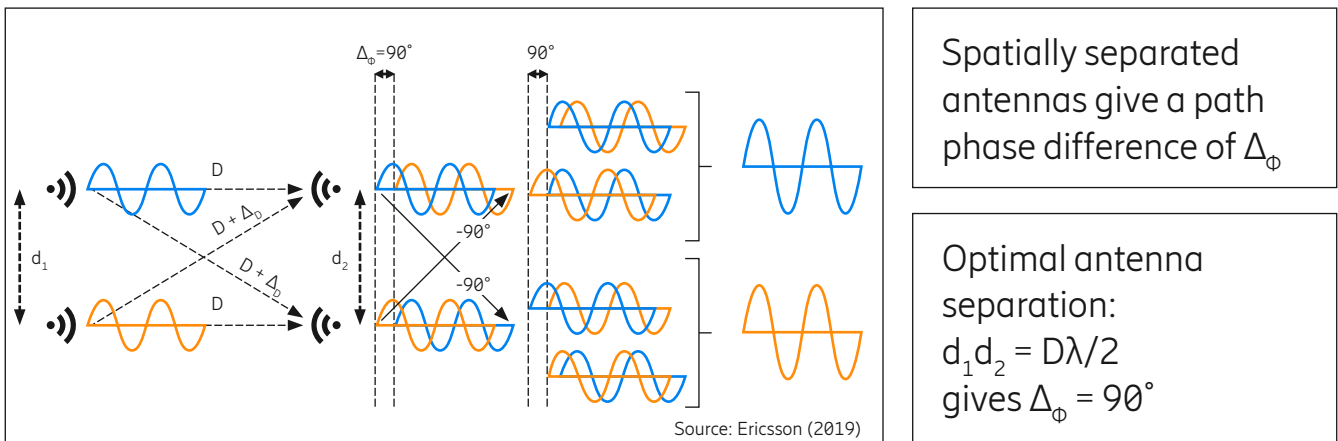

Principle of MIMO for microwave transmission where the spatially separated antennas gives a path length difference of Δ_ϕ , which corresponds to a phase difference of 90deg between the direct path and the cross path. By phase shifting by 90deg and summing the received signal, the two data streams are restored perfectly and without any losses.

Figure 13: Optimal antenna separations for a 2x2 MIMO system

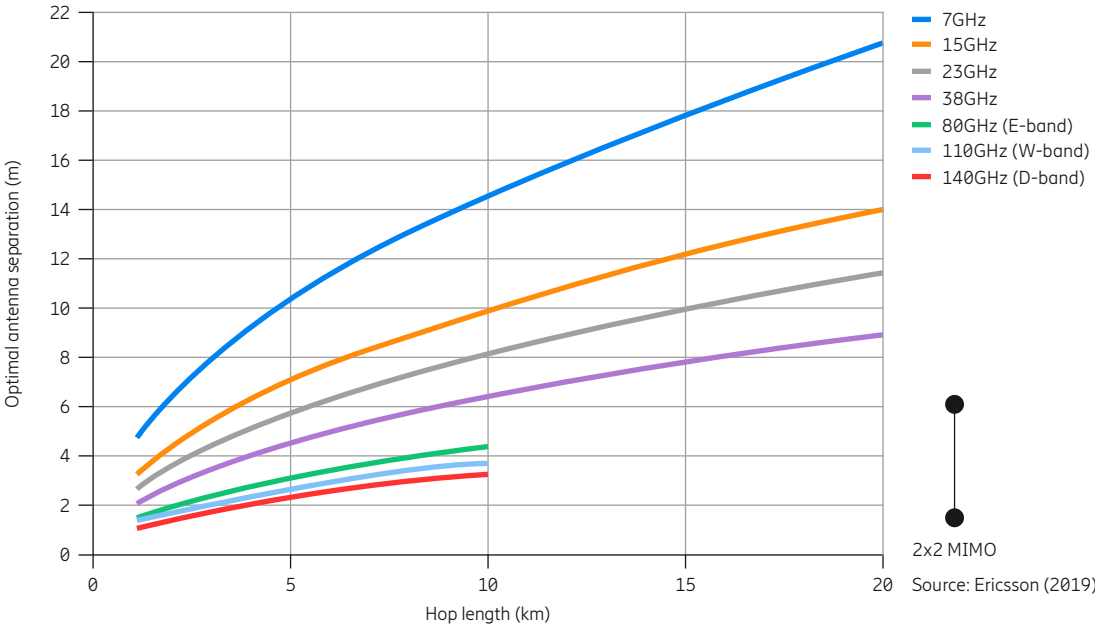

where the number of transmit antennas equals the number of receive antennas (a NxN MIMO system). Dual-polarized antennas may also be used in MIMO systems. For example, a system with two dual-polarized antennas on each side of the link is equivalent to a 4x4 MIMO system. When it comes to deployment, the antennas may appear in different arrangements. For example, the antennas in a 4x4 MIMO system may be deployed in a square grid, along a line, or even in an L-shape if required. Often, physical site constraints dictate the deployment.

Figure 12 illustrates the principle of a 2x2 MIMO system, where a first transmit antenna is used to transmit a first signal

data stream (blue), while a second transmit antenna (separated by a distance d_1 from the first antenna) is used to transmit a second signal data stream (orange). Both signal data streams are received by two receiving antennas (separated by a distance d_2) that are located at a distance D away from the transmitting antennas. Both signals are received by each one of the receiving antennas, which causes them to interfere with each other. However, it is possible to deploy the antennas in terms of separations d_1 and d_2 in such a way that there is an optimal phase shift Δ_ϕ of 90 degrees between the cross-channels relative to the direct channels. This means that by employing a proper interference

cancellation scheme in the receiver, the interfering signals can be completely removed from the signals of interest. This can be done perfectly and without any performance loss if the Δ_ϕ corresponds to a 90 degree phase shift and, correspondingly, a Δ_ϕ of 90 degrees is said to be given by the optimal antenna separation. There are many antenna separations that give a Δ_ϕ of 90 degrees, but the optimal one is defined as the smallest separation, depending on the hop length D and wavelength λ (or frequency).

Figure 13 shows the optimal antenna separation in a 2x2 MIMO system for different frequencies versus hop length.

Figure 14: MIMO capacity depending on antenna arrangement

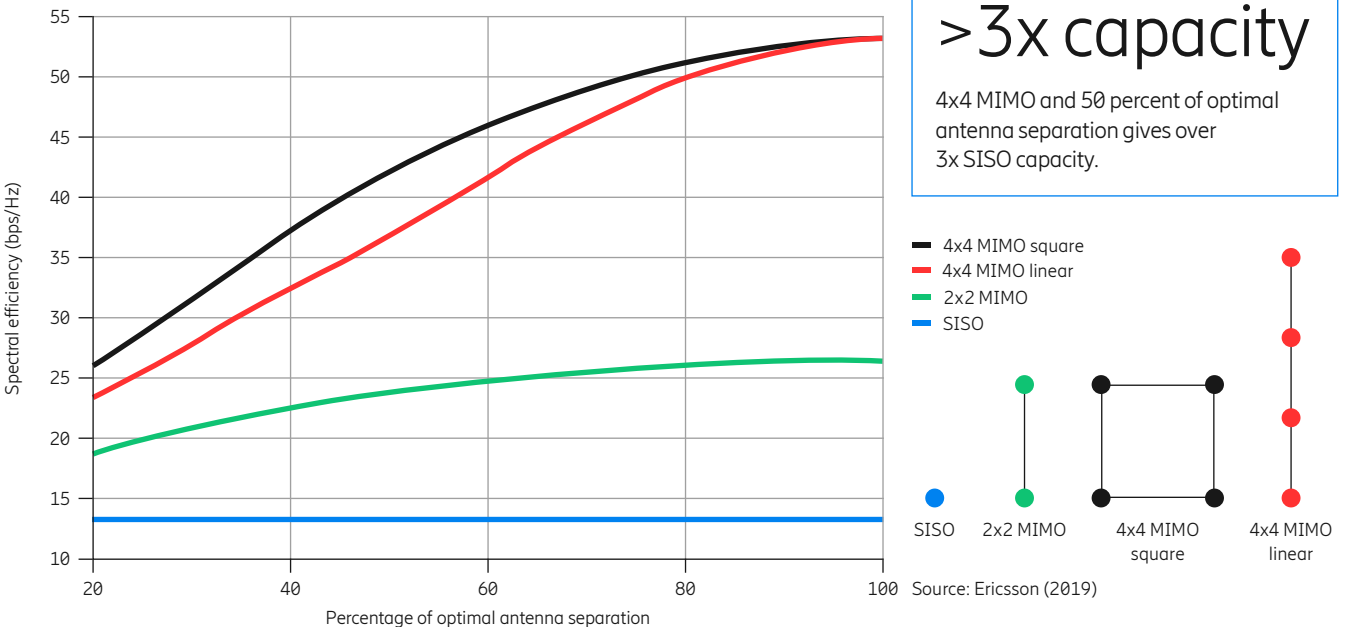

> 3x capacity
 4x4 MIMO and 50 percent of optimal antenna separation gives over 3x SISO capacity.

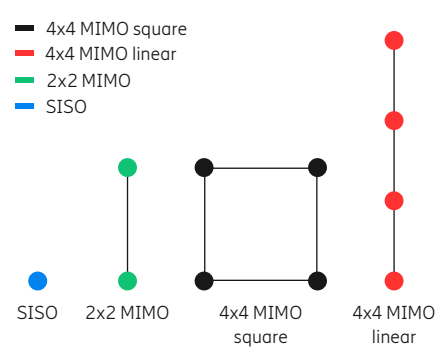

Source: Ericsson (2019)

Figure 15: MIMO capacity and availability trade-off for sub-optimal antenna arrangements

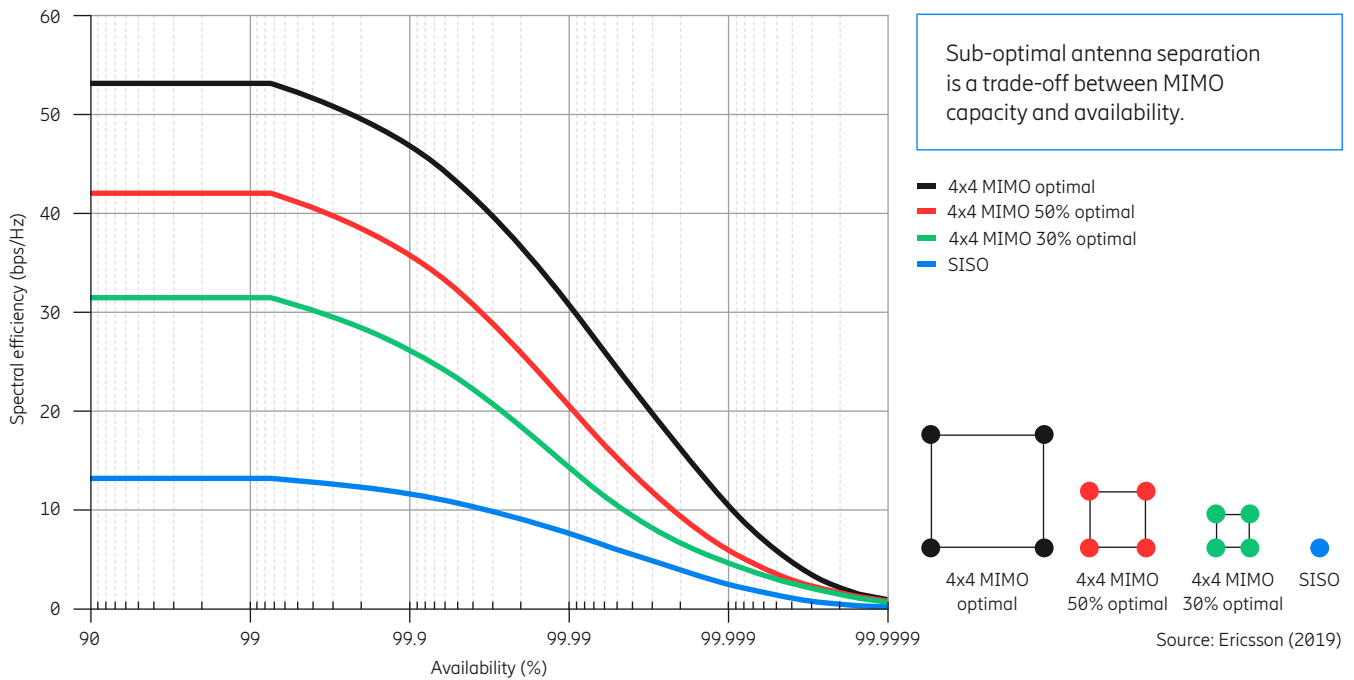

Higher frequency or shorter hop lengths allow for the use of smaller antenna separations, which makes the MIMO installation more compact. It should also be mentioned that it is possible to use sub-optimal antenna separations, as it may not be practical in some deployments to use the optimal antenna separation, due to it simply being too large. The effect of sub-optimal antenna spacing is shown in Figure 14, where the MIMO capacity (spectral efficiency) is plotted against various degrees of sub-optimal antenna spacing for different MIMO antenna deployments. It shows how the capacity drops as the antennas become more sub-optimally spaced. However, even at 30 to 50 percent of optimal spacing, there is a huge capacity gain over a SISO system. The figure also shows that different antenna arrangements have different properties when the antennas are sub-optimally spaced. The square 4x4 MIMO deployment is more robust in comparison to sub-optimal spacing at the Signal-to-Noise Ratio (SNR) used in this example (the typical SNR of a microwave radio link).

In principle, the use of sub-optimal antenna separations will give a penalty in system gain, which in practice translates to a loss in availability. Figure 15 shows the effect of sub-optimal antenna separation in 4x4 MIMO systems deployed in square arrangements. It should be noted that the capacity drops when reducing the antenna spacing for fixed availability. Equally, it should also be noted that the availability will be lessened when reducing the antenna spacing for a fixed capacity. Therefore, the use of sub-optimal antenna spacing is a trade-off between MIMO capacity and availability.

A way to reduce the loss in capacity (or availability) when using sub-optimal antenna spacing is to use something called precoding. Precoding can be seen as a generalization of beamforming, where each data stream is transmitted over all (or a subset of) the antennas and with individual weighting (amplitude and phase) across the antennas. For example, the weighting can be chosen so that the Signal-to-Interference-and-Noise Ratio (SINR) of each data stream is maximized at the

receiver side. Precoding will, therefore, put constraints on the phase synchronization of the radios in order to work properly. In MIMO systems without precoding, each individual data stream is transmitted from a single antenna, as depicted in the 2x2 MIMO system in Figure 12.

Optimizing MIMO for maximum effect

MIMO is a spectral-efficient multiple-antenna technology that can be used when the available spectrum is scarce or to enable >100Gbps in wide-band channels. The optimal antenna arrangement depends on the desired MIMO order, frequency and hop length. Sub-optimal antenna arrangements are possible, and sometimes even required, due to site installation constraints, but they will give a performance penalty in terms of reduced capacity and/or availability. Precoding over phase-synchronized transmitters can, to some extent, alleviate the penalty of using sub-optimally spaced antennas.

Breaking the 100Gbps barrier

The 100Gbps wireless transport barrier is broken by combining E-band radios with MIMO technology. Through this, 139Gbps over 1.5km was achieved, with high availability and low latency in a 2.5GHz channel.

Wireless backhaul's steady evolution over the last 40 years has been a response of continuous adaptation to the requirements of services enabled by new generations of mobile technology. The first commercial 100Mbps point-to-point links were available around the mid 90's; the first links supporting Gbps capacities emerged around 2010; and the first commercial links supporting 10Gbps recently became available. With this long-term trend in mind, point-to-point links supporting more than 100Gbps capacities are expected to be commercially available within the next 5–8 years.

The key to increased capacity for previous backhaul generations has been accessing new frequency bands, wider channel bandwidths and higher modulation schemes. However, evolving along that path from today's 10Gbps links to 100Gbps

would require a tenfold increase in channel bandwidth. This is not sustainable for large deployments of 100Gbps links, even with access to excessive spectrum beyond 100GHz. Due to this, new spectrum-efficient technologies such as line-of-sight MIMO will play a pivotal role in the commercialization of future ultra-high capacity point-to-point links. As described in the previous article on MIMO, this technology will multiply the spectrum efficiency, while maintaining or improving the system gain, enabling spectrum-efficient, high-capacity links over similar distances to today's backhaul links. To test MIMO in microwave fixed services, Deutsche Telekom and Ericsson jointly trialed a 100Gbps, 8x8 MIMO system using a single 2.5GHz channel in the E-band. The trial took place in April 2019 at the Deutsche Telekom Service Center in Athens, Greece.



This article was written in collaboration with Deutsche Telekom.

Deutsche Telekom is one of the world's leading integrated telecommunications companies, with some 178 million mobile customers, 28 million fixed-network lines, and 20 million broadband lines in more than 50 countries. They provide fixed-network/broadband, mobile communications, Internet, and IPTV products and services for consumers, and information and communication technology (ICT) solutions for business and corporate customers.

Figure 16: A 100Gbps hop at OTE Academy in Athens, Greece, stretching over 1.5km towards OTE headquarters



Figure 17: Measured throughput and constellation diagram per MIMO channel

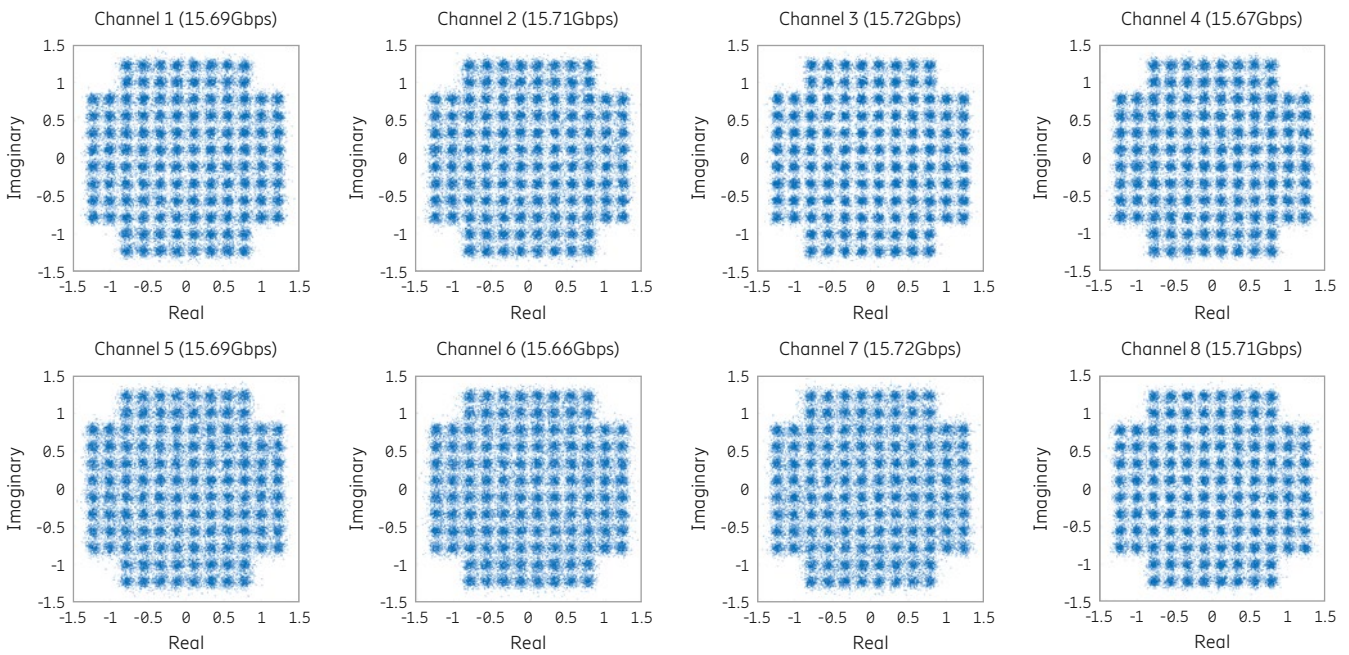

Example of throughput and constellation diagram per MIMO channel at 128QAM and 5dBm output power in a single 2.5GHz channel. Error-free throughput is 126Gbps.

Source: Ericsson and Deutsche Telekom (2019)

A 1.5km link connecting the OTE headquarters (Hellenic Telecommunications Organization) in the Maroussi area with the OTE Academy (Figure 16) was used as the testbed. Four 0.6m parabolic reflector antennas were separated by 1.7m, which is the optimum antenna separation for a hop with a 73GHz carrier. Each antenna was deployed with two commercial Ericsson E-band radios in orthogonal polarization states. At the receiving end, the signals were received by a similar set of radios, recorded by a digitizer and evaluated offline. The modulation scheme was changed from 64QAM to 128QAM and 256QAM, corresponding to a total bitrate of 105Gbps, 126Gbps and 139Gbps respectively in a 2.5GHz channel, and 84Gbps, 99Gbps and 113Gbps respectively in a 2GHz channel. The following experimental measurements were done in a 2.5GHz channel.

Figure 17 shows an example of the received constellation diagrams with 128QAM modulation, 5dBm transmitted power per radio and optimal antenna separation. The bit error rate for each channel is shown after error correction and the error-free throughput for all 8 channels combined is 126Gbps.

The left side of Figure 18 shows the antenna arrangement on the roof of OTE Academy, with the antennas arranged at optimum separation. The robustness of the antenna separation was tested by shifting

the two lower antennas on one site towards the upper antenna row as shown in Figure 18 (right), first by 0.4m and then by 0.8m offset. Figure 19 shows measured throughput versus output power per radio for the three modulation formats. The power budget for 105Gbps throughput was higher than 25dB, resulting in a rain-limited availability better than 99.99 percent in Greece. This power budget would allow operation over long hop lengths with high availability in, for example, MBB configurations. Running a similar setup over a 7km hop would have resulted in 105Gbps capacity, with better than 99 percent availability.

The tolerance to reduced antenna separation is robust; a 0.8m offset results in availability estimated to be better than 99.99 percent for >100Gbps. A 135Gbps hop was reached with a power budget of 17.5dB, corresponding to availability of 99.97 percent.

The high throughput will result in a latency reduction. We expect a linear latency decrease with increased bitrate, resulting in a round-trip time below 5μs at 100Gbps. The radio units used in the trial were commercial, off-the-shelf E-band radios, further demonstrating the potential of this band. When moving to new frequency bands beyond 100GHz, more channels will be available to handle bandwidths in the order of a few GHz and, in fact, the optimum

>99.995%

Availability of >100Gbps over 1.5km is more than 99.995 percent.

antenna separation between the antennas will decrease. For example, operating the same 1.5km hop on a W-band (110GHz) or a D-band (140GHz) carrier instead of an E-band carrier would result in an optimum antenna separation of 1.4m and 1.2m, respectively. The individual antenna sizes will be reduced for the same antenna directivity, leading to an overall reduction of the installation footprint. For short hops up to 500m, it will be possible to put all four antennas within one box, thus enabling single-box 100Gbps links. These high-frequency bands are therefore well-suited for future 100Gbps installations.

The work presented in this article shows the importance of applying spectral efficiency techniques, such as MIMO, on wireless backhaul. It demonstrates 100Gbps links with sub 5μs latency and telecom grade availability over hops measurable in kilometers with commercially available E-band radio technology. The need to process large amounts of high-speed data in parallel puts demanding requirements on cost and power consumption for the digital processors.

Figure 18: Antenna arrangement for the 100Gbps link at optimum antenna separation (left) and with 0.8m antenna offset (right)

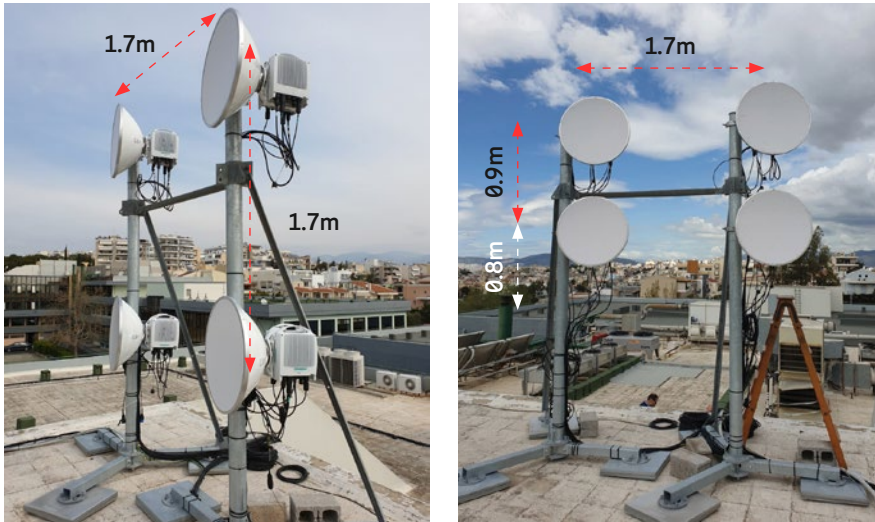

Source: Ericsson and Deutsche Telekom (2019)

We expect the first 100Gbps links to be deployed in 5 to 8 years, given the technology development in this field but also depending on the potential market demands.

Market demand for increased capacity support continues to increase. Reaching 100Gbps and beyond is still far from today's capacity requirements in the access domain, which is typically in the order of 1Gbps, while ongoing capacity upgrades in advanced broadband networks are toward the 10Gbps milestone. However, in the aggregation networks (aka Edge/Core), capacity requirements are scaling from 10 to 100Gbps and this is most likely where we can initially expect these types of links.

These ultra-high capacity links will act as a cost and time-efficient complement to fiber supporting ring closure, geographical redundancy in service provider networks or in private networks, such as campus and enterprise solutions. As a second phase, speeds in the pre-aggregation network segment and small cells fronthauling will drive up the last-mile capacities in multiples of 10/25Gbps. The single-box 100Gbps links may be used for ultra-high capacity connections in dense urban areas inter-site distances of a few 100m. It is evident that microwave is well prepared for the network evolution of 5G and beyond.

139Gbps

In the trial, 139Gbps over 1.5km with an availability of more than 99.9 percent was achieved.

Figure 19: Measured throughput versus transmitted output power per radio at optimal antenna setup and with 0.4m and 0.8m offset

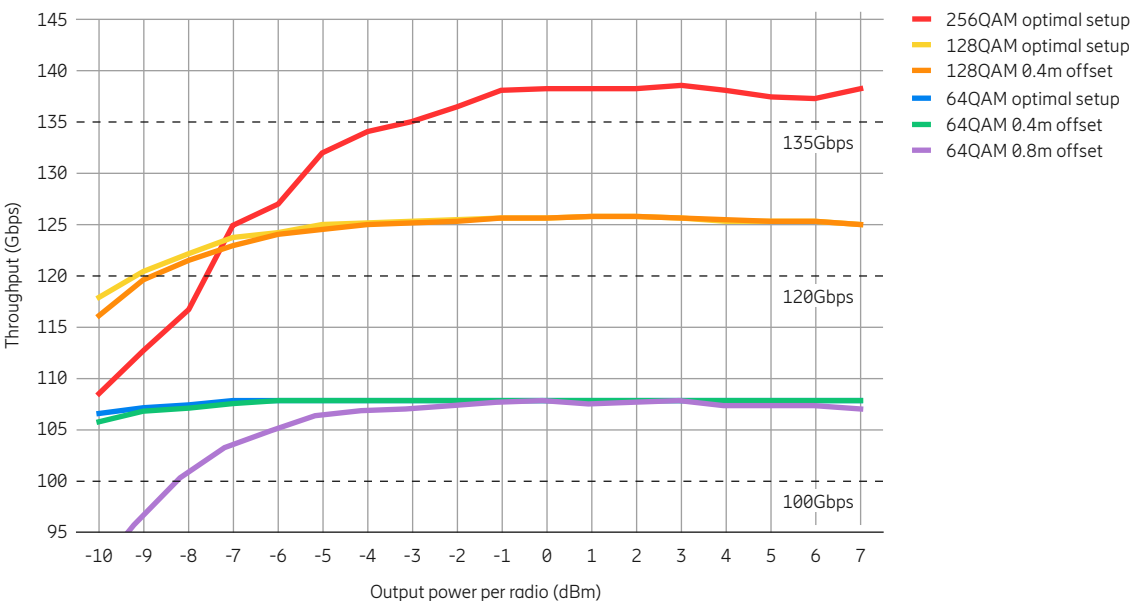

Source: Ericsson and Deutsche Telekom (2019)

Ericsson enables communications service providers to capture the full value of connectivity. The company's portfolio spans Networks, Digital Services, Managed Services, and Emerging Business and is designed to help our customers go digital, increase efficiency and find new revenue streams. Ericsson's investments in innovation have delivered the benefits of telephony and mobile broadband to billions of people around the world. The Ericsson stock is listed on Nasdaq Stockholm and on Nasdaq New York.

www.ericsson.com