

5G deployment considerations



ericsson.com/5g

Building for the future in today's networks

5G networks will enable enhanced mobile broadband (eMBB) services – with higher data rates, lower latency, and more capacity – as well as new use cases that will generate additional revenue streams for operators. Ericsson has defined a natural, step-wise implementation strategy for 5G that builds on today's networks to minimize risk and roll-out costs.

Introduction

5G radio access networks, based on the New Radio (NR) standard, will provide new levels of capacity, peak data rates and low latency – with the ability to offer data rates of many tens of megabits per second to tens of thousands of users at the same time. They will not only help operators demonstrate technology and performance leadership, but also meet growing mobile traffic demands profitably by delivering new levels of cost-efficiency (including spectrum efficiency and sharing current assets), digitalization and new revenue streams.

Ericsson's philosophy is to enable evolution to full 5G deployment through manageable steps, based on well-designed components of multiple technologies, in a way that matches business and technology realities.

5G will enable enhanced mobile broadband (eMBB) services, and create huge potential for new value-added wireless services through a wide range of new use cases. These new use cases include fiber-equivalent Fixed Wireless Access (FWA) services, massive Internet of Things

(IoT) services, and critical IoT – enabling new applications in the automotive, manufacturing, energy & utilities and healthcare sectors, among others.

Unlike previous generations of Radio Access Network (RAN) standards, which were deployed as stand-alone networks, 5G NR is designed from the start to interwork fully with existing 4G LTE networks. While this provides a high degree of continuity and seamless experience for users, it also demands careful planning in order to minimize risk to existing services.

To ensure the smooth introduction of 5G, operators need to look ahead and identify the deployment approach which makes best use of existing investments and best supports their own business strategies. This applies whether the operator is already hitting a capacity ceiling in the busiest parts of its 4G network or only just beginning to deploy 4G, and whether or not it already has access to new spectrum for 5G. The time to start developing and market-testing new business models is now, as operators prepare their current networks for 5G deployment.

Ericsson's philosophy is to enable evolution to full 5G deployment through manageable steps, based on well-designed components of multiple technologies, in a way that matches business and technology realities.

Turbocharging mobile broadband; unlocking new business models

The introduction of 5G NR can be seen as a way to ‘turbocharge’ existing mobile broadband business – with extremely high throughput and low latency – while also opening up potential for new business models in a wide range of commercial and domestic applications.

There is no single ‘killer application’ for 5G; its introduction should be seen as a way of evolving and expanding the successful business that operators have established on their existing networks. Key objectives have to be successful coexistence and continuous growth.

5G enhanced MBB will deliver a significant reduction in cost per bit compared with 4G MBB, and this will continue to reduce (thanks to increased spectral efficiency, higher network utilization, greater user numbers and higher average speeds). Access to new and wider spectrum also delivers efficiencies.

What 5G radio access also adds, above all – in consort with new core network capabilities – is new levels of flexibility, and the potential to address multiple new use cases in a highly responsive and efficient way. It is both an enabler for existing business growth as well as a platform for future business innovation.

Introducing 5G will help operators increase overall revenue, based on new use cases, and avoid commoditization of their services. This ability to handle multiple,

tailored use cases is what makes 5G more disruptive than previous generations of cellular technology.

Based on studies carried out in partnership with universities, business analysts and enterprise customers, Ericsson has identified five important areas of use case development, enabled through the evolution of current 4G networks to full 5G-enabled experience, as shown in Figure 1.

This ability to handle multiple, tailored use cases is what makes 5G more disruptive than previous generations of cellular technology.

A key point here is that operators’ choice of technologies, and where and when to deploy them, must support business needs, and not vice versa. For example, it makes sense to develop and test the market for new massive IoT services in the existing 4G environment before deciding when, or whether, to roll out enhanced versions of these services over 5G access.

Some examples of existing technologies that may be needed to support these use cases include:

- Multi-standard 2G, 3G and 4G networks to provide robust coverage and performance

- Category M1 (Cat-M1) and/or Narrowband IoT (NB-IoT) LTE-based technology to enable massive IoT use cases
- Cloud-optimized network functions; the virtualized network functions adapted to cloud delivery, based on stateless microservices
- Virtual Network Function (VNF) orchestration; automated procedures to onboard software-based network functions from multiple vendors, with the option to use commercial, off-the-shelf (COTS) hardware.

Some operators are already starting to deploy more advanced technologies that pave the way to 5G capabilities, including:

- LTE Advanced (Gigabit LTE) for much higher peak rates
- Massive Multiple Input, Multiple Output (MIMO) multi-antenna transmission technology to significantly increase the number of transmission ports to boost network capacity and data throughput
- Network slicing, which enables virtual networks, running on a shared infrastructure. These network slices can be tailored to the requirements and services for a certain industry segment or enterprise
- Dynamic service orchestration, which enables cross-domain provisioning and fulfillment of services
- Predictive analytics, using smart analytics-driven planning, to predict the bandwidth required to deliver the best experience.

Figure 1: Use case evolution and supporting technologies.

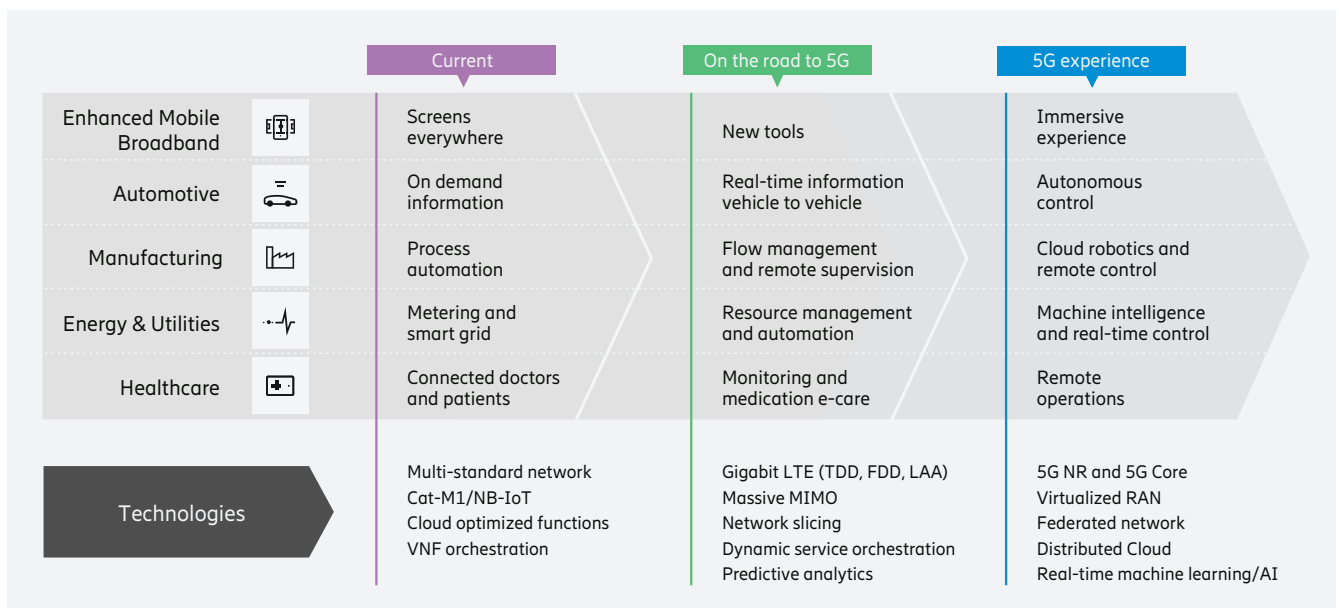

Delivering the full 5G experience will involve enhancing many existing use cases and creating new ones that cannot be fulfilled using current technologies, through:

- Deploying 5G NR radio access to deliver capabilities far beyond those of previous cellular generations, including massive system capacity, very high data rates, very low latency, ultra-high reliability and availability, low IoT device cost and energy consumption, and energy-efficient networks – wherever and whenever needed
- Federated network slicing, to enable ‘roaming’ of network slices to other networks in order to provide global reach for services for enterprises or roaming subscribers
- Distributed Cloud, to enable workloads to be placed closer to the network edge for better QoS (shorter latency), transport efficiency and higher integrity of data
- Real-time machine learning and artificial intelligence, as analytics become important for the delivery of self-optimizing networks and meeting service level agreement (SLA) obligations.

What will be paramount for operators is to be able to take the technology steps that will ultimately deliver the full 5G experience – and multiple new use cases – as smoothly and cost-efficiently as possible, with investment aligned with new business revenue.

Operators need a 5G implementation strategy that balances investment, new revenue streams and competitiveness.

5G: where, when and how?

Decisions on where, when and how operators deploy 5G are not only driven by commercial considerations – including greater user numbers, TCO reduction (through energy-efficiency, automation and RAN slicing) – but also on the availability of spectrum, network equipment and devices. It is worth noting that many new use cases can use 4G today and move to LTE Advanced and NR in the future. It makes sense to start developing new use cases as soon as possible, using the best technology available.

The first 5G standard (Release 15, NSA - non stand-alone - mode, Option 3) was finalized at the end of 2017. Fully standard-compliant radio systems will likely be available at the end of 2018. This means we expect to see 5G start being deployed by leading operators during 2019.

As 5G will need to coexist and interwork with 4G for many years to come, we’re likely to see the vast majority of these deployments as non stand-alone (NSA) initially, as a way of reducing time to market and ensuring good coverage and mobility. The 5G standard for stand-alone (SA) mode is planned for first release mid-2018. This mode, which requires a new (service-based) core network architecture (known as 5G Core, or 5GC), will enable deployments of 5G as an overlay to or independent of 4G coverage. The new service-based core network has many important properties, including advanced network slicing support, both SIM and non-SIM authentication support and multi-access handling.

Initial use cases for 5G will be eMBB and FWA, although this will vary from market to market. For example, in China and South Korea, operators are running out of LTE

capacity, especially in cities, while many developing countries have not started deploying LTE yet.

As 5G will need to coexist and interwork with 4G for many years to come, we’re likely to see the vast majority of these deployments as non stand-alone (NSA) initially, as a way of reducing time to market and ensuring good coverage and mobility.

Initially, eMBB is likely to be by far the biggest use case for 5G globally. This is because it can provide an enormous capacity and peak rate boost wherever increased spectrum is available, thanks to the very wide carriers in high bands and the beam-forming ability of NR radios. The optimized lean design of 5G NR offers both increased spectral efficiency and lower cost per bit.

To achieve nationwide coverage as fast as possible, we’re also likely to see 5G deployed in low/mid bands, which will also be suitable for massive IoT use cases in the future. Deployment of 5G NR in low bands, such as 600 or 700 MHz, is of interest in USA, for example, to boost coverage. Deployment in mid bands may also be driven by earlier availability of spectrum in these bands (compared with high bands). SA 5G in high bands is more likely to be used mainly for data offload in high-traffic areas, as separate networks in factories or campuses, and for critical IoT in data-intensive applications.

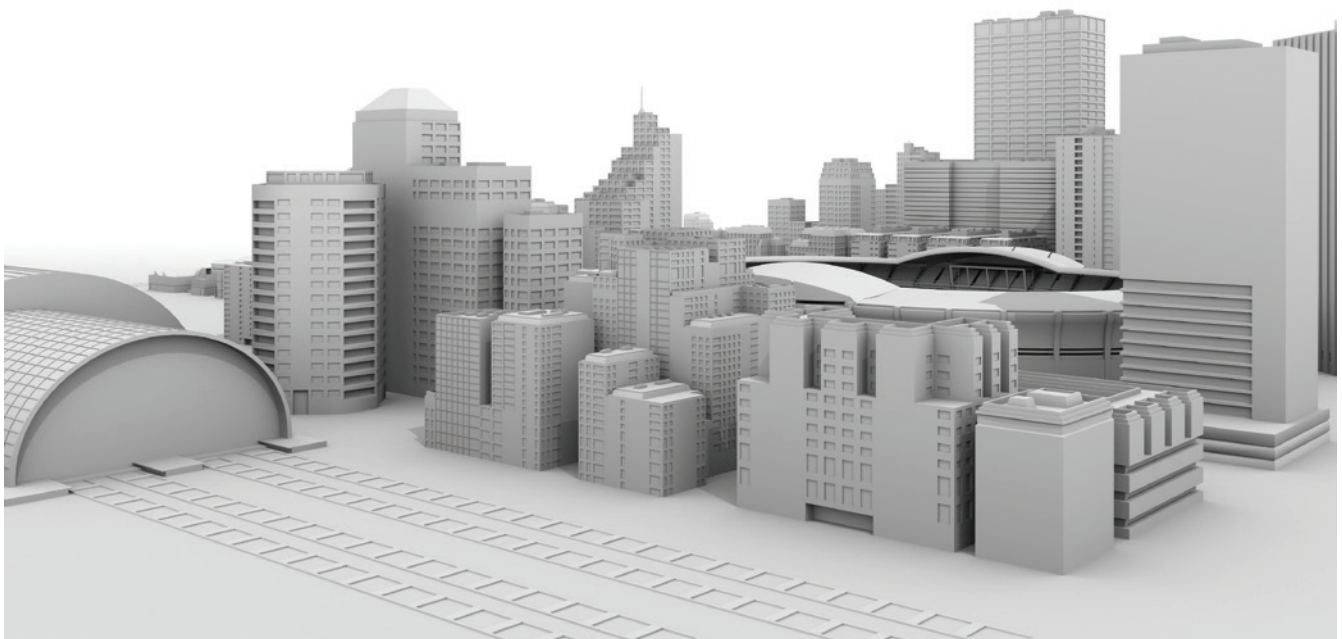

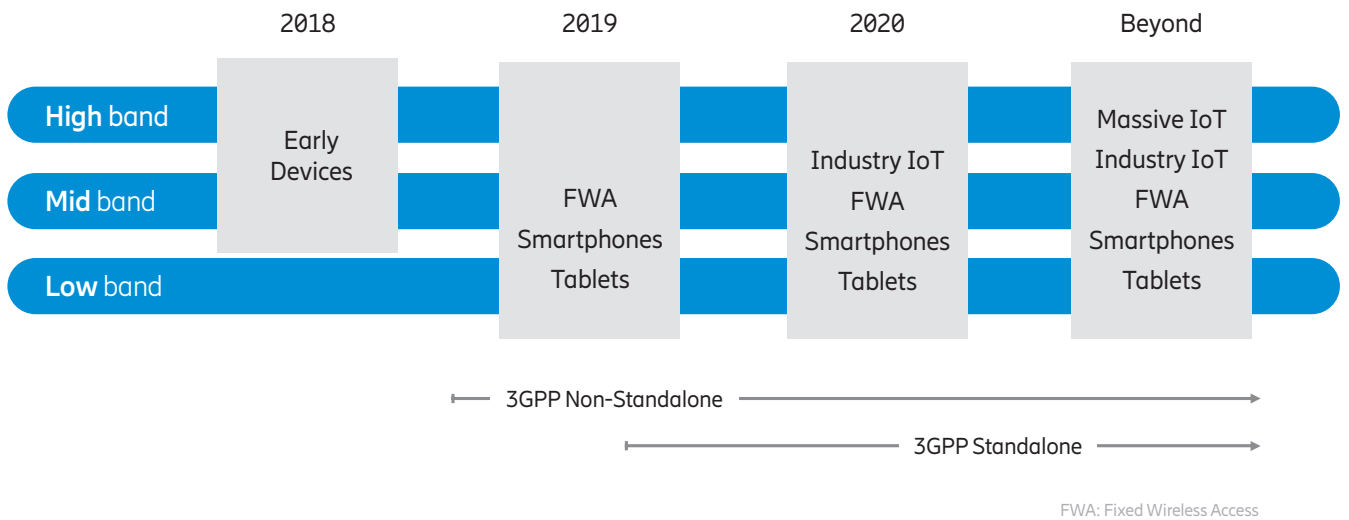

Figure 2: 5G device availability.

Device availability

Figure 2 shows the approximate timing of 5G device availability. Early FWA devices have been developed to meet market needs in the USA and Australia for example. The first 3GPP-compliant 5G smartphones and tablets are likely to be launched in 2019.

To date, the IoT business has primarily been driven by the affordability of devices. Costs of 3GPP-compliant devices have come down significantly recently, and as they approach 5–10 euros, we are starting to see the cellular-delivered IoT market becoming better established. The market for industrial IoT, or critical M2M, services is at an earlier stage, but will likely be a significant market in the longer term.

We foresee 3GPP systems becoming the IoT technologies of choice for operators and industry in the longer term.

The first 3GPP-compliant 5G smartphones and tablets are likely to be launched in 2019.

The global spectrum picture

Operators will need more spectrum for 5G, not least because its benefits are fully achieved in new millimeter wave frequencies, with extremely wide bands. Here, the ultra-high peak rates and low latency are most likely to be used by operators to add new levels of capacity and throughput for enhanced mobile broadband, especially as a way of offloading congested 4G networks (and for new special use cases). But there is also broad interest in deploying 5G technology in new mid bands (3.5–6GHz) and existing, legacy mid bands (1,800–2,600 MHz) as a way of achieving national 5G coverage as rapidly as possible.

Operators will need to develop their spectrum strategies based on their own particular business focus, and the frequencies available to them, today and in the future. Utilizing legacy spectrum in combination with new bands enables operators to serve a wider variety of use cases more efficiently and, in many cases, more quickly; the whole can be greater than the sum of the parts.

Figure 3 gives a general indication of spectrum availability across all RAN generations over time. The spectrum available to 5G will vary from market to market, according to whether it is already in use and the timing of auctions and licensing processes.

Utilizing legacy spectrum in combination with new bands enables operators to serve a wider variety of use cases more efficiently and, in many cases, more quickly; the sum of the parts can be greater than the whole.

Figure 3: Spectrum allocation over time.

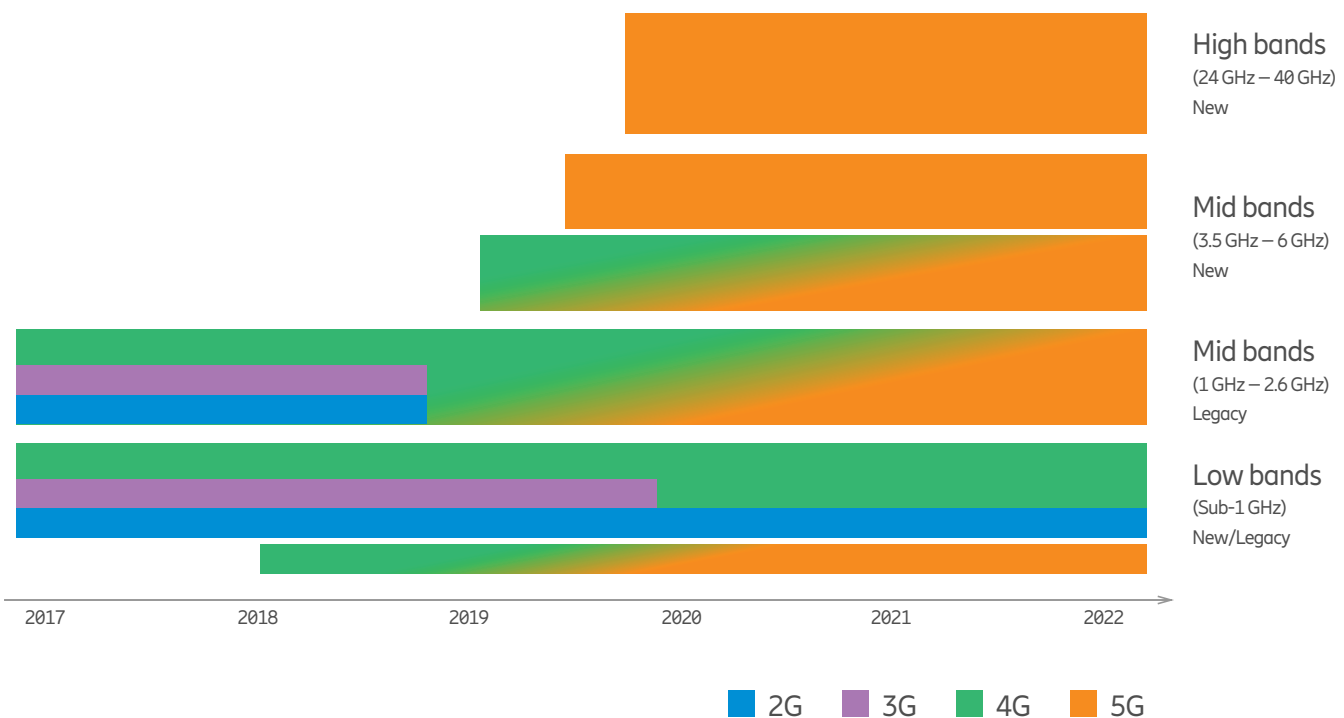

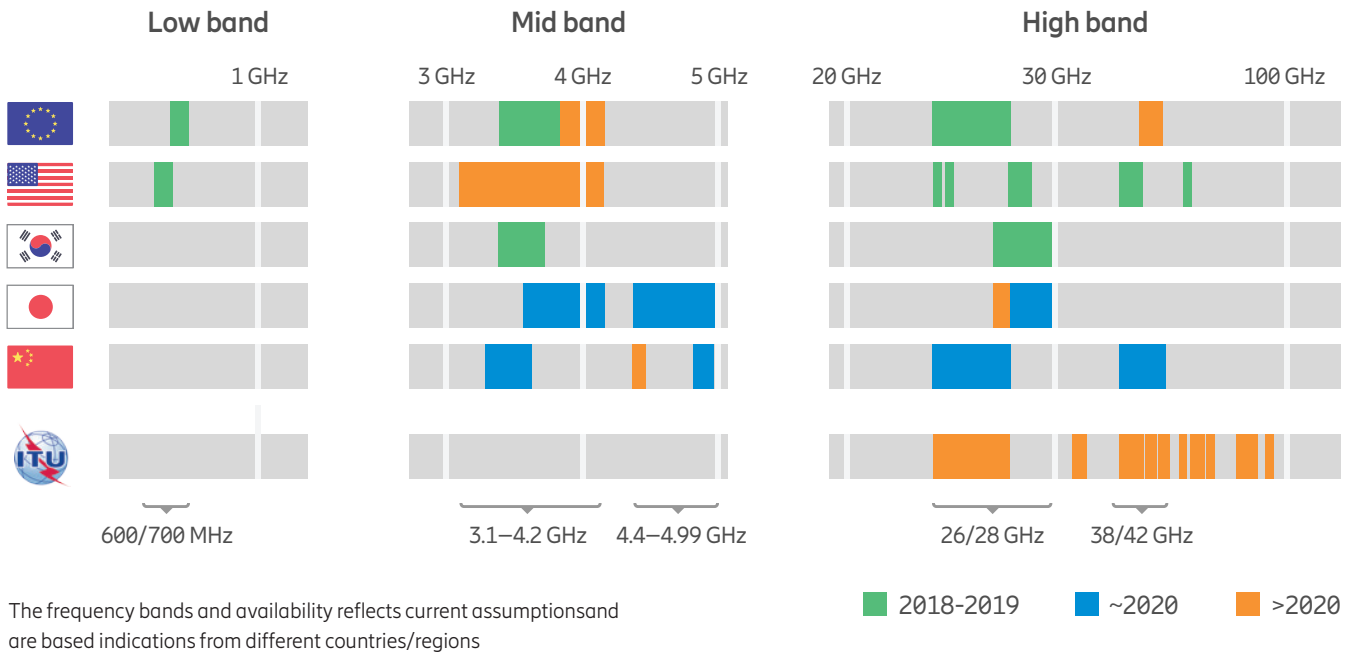

Figure 4: 5G spectrum availability around the world.

Early roll-outs of 5G in Europe and Asia will likely use mid-bands, while in the USA operators will mainly start with high bands for 5G, and re-farm some 4G low bands.

As can be seen in Figure 4, different bands are being made available for 5G NR in different parts of the world. The World Radiocommunication Conference (WRC) did not vote for any particular 'unifying' spectrum, but there is broad convergence on mid-bands, especially 3.5 GHz. Early roll-outs of 5G in Europe and Asia will likely use these mid-bands, while in the USA operators will mainly start with high bands for 5G, and re-farm some 4G low bands.

Each spectrum band has different physical properties, meaning there are trade-offs between capacity, coverage and latency, as well as reliability and spectral efficiency, as illustrated in Figure 5. If the network is optimized for one metric, there may be degradation of another metric.

These trade-offs need to be taken into consideration when planning 5G deployments, especially with regard to the operator’s service focus, whether this is enhanced mobile broadband, massive IoT, critical IoT or Fixed Wireless Access, for example.

Low-band spectrum has historically been used for 2G, 3G and 4G networks for voice and mobile broadband services, as well as broadcast TV. The available

bandwidth is typically between 10 MHz and 30 MHz. This makes this spectrum most suitable for wide-area and outside-in coverage from macro base stations. For a typical 5G mobile broadband use case, capacity and latency are similar to 4G on the same band.

Legacy mid-band spectrum is currently used for 2G, 3G and 4G services. New mid-band spectrum has typically been allocated in 3.5 GHz spectrum bands. In these bands, especially in the new higher spectrum, we are likely to see larger bandwidths (50–100 MHz). This will enable high-capacity, lower-latency networks which can be used for new 5G use cases, with better wide-area and indoor coverage than higher-band spectrum.

Each spectrum band has different physical properties, meaning there are trade-offs between capacity, coverage and latency, as well as reliability and spectral efficiency.

Figure 5: Spectrum trade-off.

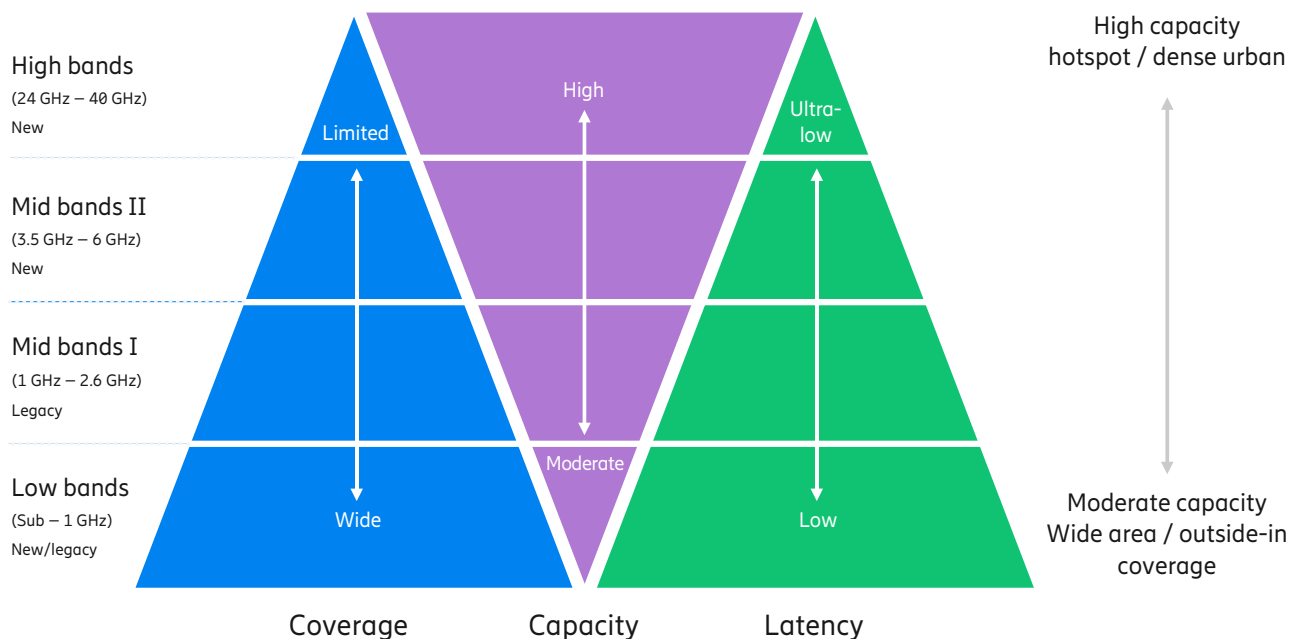

Source: IEEE – A survey on Low latency towards 5G RAN, Core network and Caching solutions.

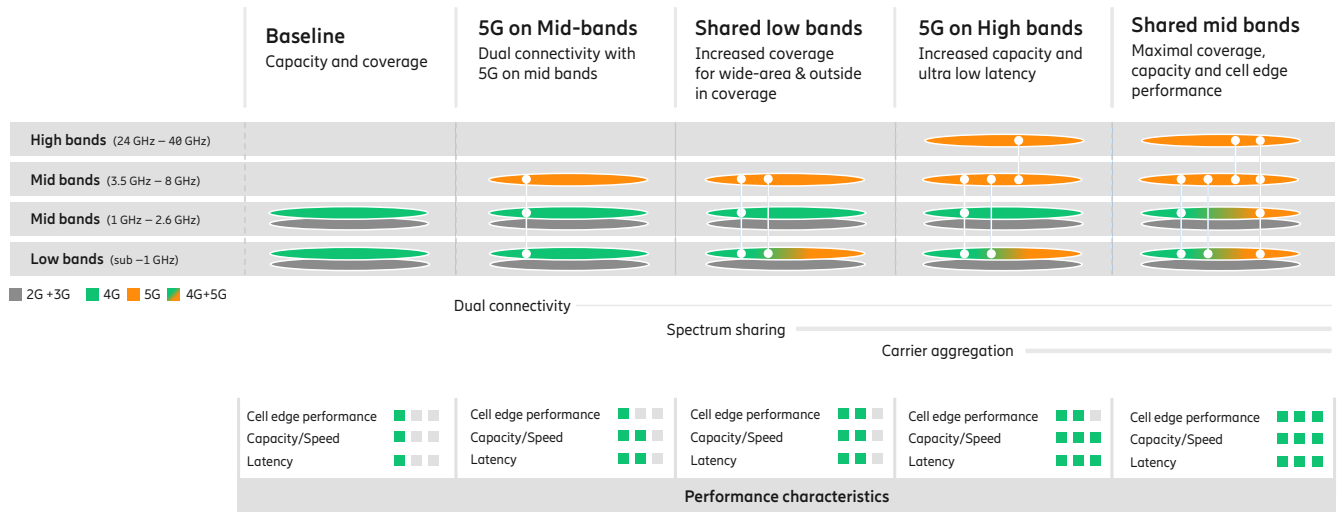

Figure 6: 5G spectrum strategy.

As mentioned earlier, high-band spectrum provides the quantum leap in performance promised by 5G. These new spectrum bands are typically in the 24–40 GHz range, with bandwidths in 100 MHz (or higher) blocks. Such large bandwidth enables ultra-high capacity networks (5–10 times higher than today), with latency as low as 1 ms. However, these higher frequencies come with a coverage limitation compared with lower bands.

Generally, we expect that initial 5G deployments will mostly be NSA in mid bands, as this approach is already standardized and enables operators to reuse their existing 4G Evolved Packet Core (EPC) networks, with a software upgrade for NSA support. SA 5G is expected to arrive first in low/mid bands, which provide a much larger coverage area and better

indoor penetration than high bands – which is better from both a marketing and business case perspective, enabling the e2e 5G System values including 5G Core.

Existing spectrum used for 4G will be migrated smoothly to 5G over time, minimizing the impact on 4G as 5G is introduced in the same band. Functions that enable smooth spectrum migration and combinations (of both bands and technologies) will be crucial for the planned evolution of the network.

There will likely be several combinations of bands and technologies (4G and 5G dual connectivity) for NSA 5G over the coming years, as traffic increases and markets mature. This will enable devices to be connected to both 4G and 5G at the same time (as shown in Figure 6).

Functions that enable smooth spectrum migration and combinations of both bands and technologies will be crucial for the planned evolution of the network.

Reducing complexity

A key challenge for operators as they implement 5G NR and new 5G Core Network (5GC) is ensuring they have the flexibility to support a multitude of new use cases while also simplifying operations. Expanding their businesses into new areas and new industries is a huge opportunity for operators enabled by 5G, but it also brings new and more diverse requirements, a need for a more flexible deployment and flexibility in trust models and authentication schemes.

Operators need ways to reduce the complexity of operations to reduce total cost of ownership. This will require automated management and orchestration capabilities that can support the promised flexibility and responsiveness.

Enabling natural evolution to 5G

Whether operators are focused on innovating and enhancing their existing use cases, exploring new opportunities with new use cases, or simply using technology leadership as a competitive differentiator, Ericsson's network technology provides an evolutionary path to 5G through incremental investments.

Fundamentally, everything must start from the same platform: the current network. This means it is vital to protect operators' existing business and minimize risk as new capabilities are rolled out.

Figure 7 shows a very approximate evolution path to 5G. Although the key technology milestones are shown as a sequence, these are not an indication of a product roadmap, and operators will have different starting points and deployment priorities.

Ericsson's basic philosophy is to ensure there is a robust 4G platform in place, which can be used to address and monetize existing use cases, and also be used as the basis for reinvestment to address the next wave.

As 5G adoption and new use cases pick up, there will likely be a need for densification of 5G coverage to deliver more capacity.

We see the deployment of SA 5G with associated 5GC beginning when devices are more widely available, new use cases start to gain momentum, and 5G has greater access to both new and existing spectrum.

Ultimately, 5G will become the mainstream cellular technology used to address multiple use cases across multiple industries.

This means operators need to have an evolution path to 5G in place today for all these systems, which both meets short-term needs and enables longer-term strategic direction (looking five-plus years ahead).

Follow the business case

The first step when deploying 5G is to analyze the business case. Incremental

new revenue streams may not justify large investments in new technology. A lot can be done using current 4G radio, transport and core network capabilities; and these can be built on through a step-wise upgrade process to 5G as dictated by the business case.

Enhancements to EPC and specifically the new 5GC network provide a range of new features including network slicing that will be key to addressing new business opportunities, as they offer different characteristics in each slice to meet the needs of different market segments and applications. Network slicing partitions network resources into logical slices in a way that caters to different business or customer segments, taking into account operational needs such as risk minimization, security needs and QoS.

Operators can already get a flavor of 5G opportunities using their existing infrastructure. They can start developing and trialing new use cases now with LTE Advanced (Gigabit LTE), with massive MIMO, for instance. For Massive IoT, LTE already offers Cat-M1 and NB-IoT devices.

Ericsson is already implementing massive IoT with operators for 4G, for example, to meet immediate market needs. Many operators are committed to using 3GPP infrastructure for such services well into the future. LTE IoT technologies like Cat-M1 and NB-IoT plug into existing infrastructure and expertise, and are now supported at lower cost.

Figure 7: Key milestones in the evolution to 5G.

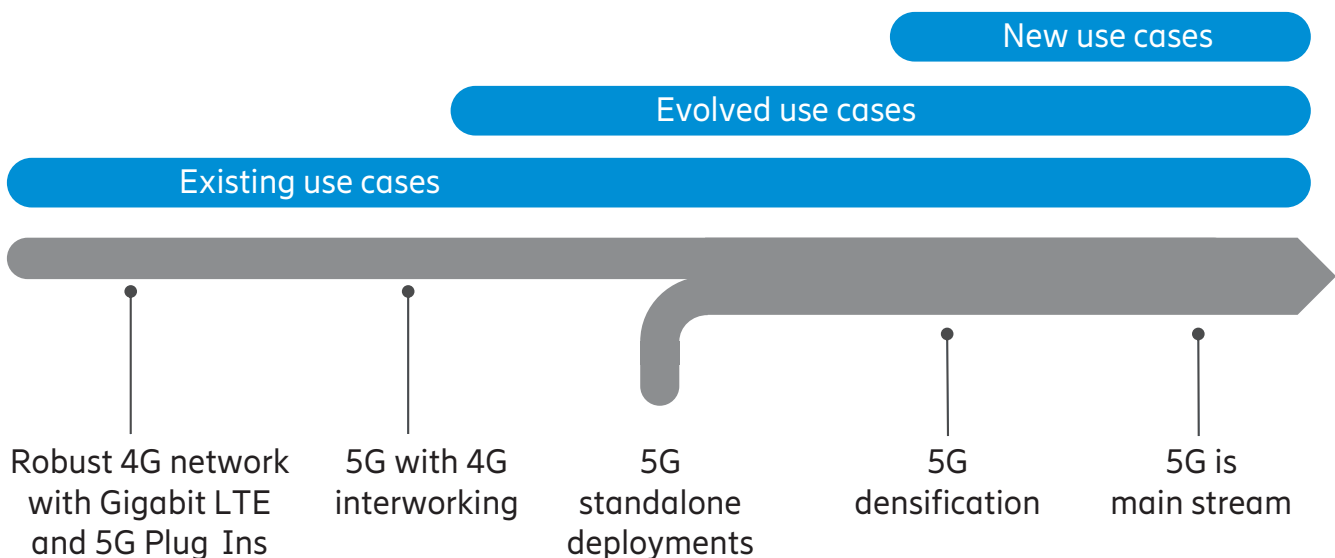

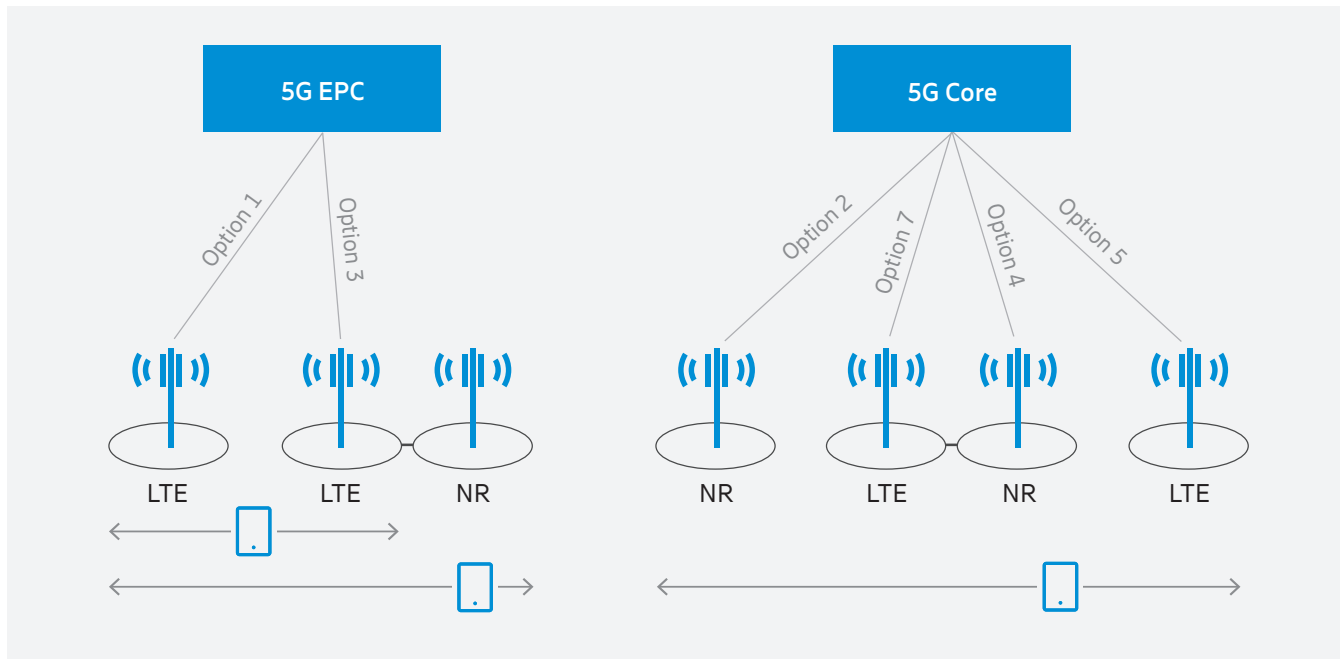

Figure 8: LTE–NR connectivity options towards EPC and 5GC.

Two-phase approach

Ericsson favors a two-phase approach to deploying 5G, in order to achieve the best time to market and maximize the reuse of existing network resources – while still ensuring the full potential of 5G can be achieved as quickly as needed.

Ericsson favors a two-phase approach to deploying 5G, in order to achieve the best time to market and maximize the reuse of existing network resources – while still ensuring the full potential of 5G can be achieved as quickly as needed.

This will use the 3GPP-standardized options for LTE–NR interworking connected to an upgraded EPC, 5G EPC (as shown in Figure 8).

At the end of 2017, NSA 5G Option 3 standardization was concluded in 3GPP, providing connectivity for combined LTE and NR systems. This option uses LTE as the control plane anchor for NR, and uses either LTE or NR for user traffic (user plane). As this approach is tied to LTE, it is important that the existing network is not disrupted. Operators can deploy dual connectivity for data (high throughput in NR downlink, best coverage in LTE uplink), while voice traffic is fully on LTE.

Ericsson sees this option as phase 1 of 5G deployment, and it will be supported in Ericsson Radio System and Evolved Packet Core (EPC) in Q4 2018. Enhanced MBB will be supported immediately and Low Latency IoT use cases will be supported during 2019/2020.

Specifications for SA 5G operation are scheduled to be concluded in 3GPP in June 2018. This creates an ‘independent’ 5G overlay, with both control and user planes

carried over 5G NR access. As part of the the standard the new 5GC is required to support SA 5G (option 2) as well as options 4, 5 and 7 (as shown in figure 8). This phase offers the greatest potential for future evolution, with many new capabilities introduced in the 5GC. Devices will also have new service handling capabilities.

The main drivers for an operator with NSA 5G to add or move to SA 5G include improved network slicing and, in the longer term, a converged core for fixed and mobile traffic. There is also a need for inter-system mobility with the existing 4G LTE network. Ericsson will offer solutions to support operators in the move from Option 3 to 5GC-based options (2,7,4,5) smoothly and cost-effectively.

For phase 2, Ericsson has chosen to start with Option 2 (5G SA) as the first solution based on the new architecture, and will support it in both RAN and core network systems in the second half of 2019.

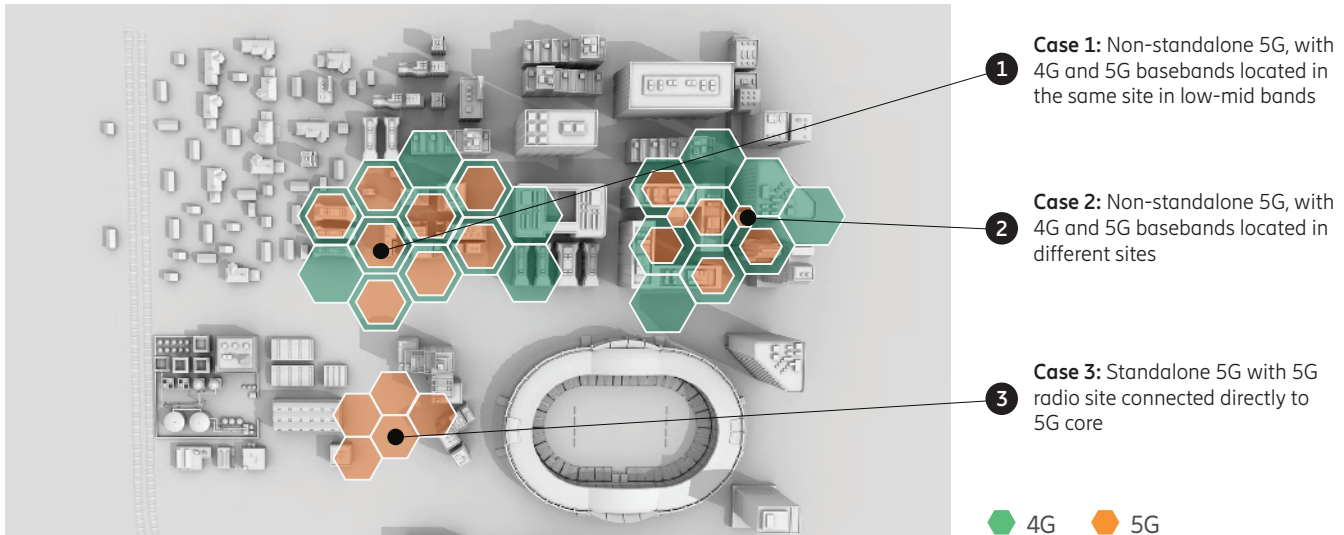

Figure 9: The three main 5G deployment cases.

Likely 5G deployment scenarios

Ericsson foresees three typical deployment cases for 5G over the coming years, as illustrated in Figure 9. We'll take a look at each of these in turn, and outline the likely architecture deployed for each one.

Some concerns have been raised that 5G is complex to deploy. However, while there is the limitation of 5G NSA being 'coupled' with a 4G network, there are no serious technical challenges in Ericsson's view.

Case 1 – NSA 5G, with 4G and 5G in similar mid/low bands

In Case 1, both 4G and NSA 5G radios are deployed in similar mid/low-band frequencies, meaning they will have very similar coverage areas, as shown in Figure 10. The greater capacity and higher speeds (peak rates) enabled by 5G NR spectrum mean operators are most likely to deploy it in high-traffic areas, typically in city and urban areas. Use cases include enhanced MBB, and FWA in wide areas.

All radios can be physically co-located and connected to the existing core network, as shown in Figure 10. With Ericsson Radio System, there is no need to change any radio equipment: existing equipment can be reused, including baseband units (assuming they have capacity) and radios (when 4G and 5G are on the same frequency). Operators can also reuse site equipment (power, cooling and transport), although transport capacity may need to be expanded to meet 5G needs.

Most operators deploying 5G in this way will already have an Evolved Packet Core (EPC) network, supporting 4G, which makes

it quite straightforward to add another RAN technology for new and existing use cases (with just a software installation to add new capabilities). There may, of course, also be a need for capacity upgrades in the EPC and transport networks.

If operators need to deploy 5G in a new, unique frequency band, this NSA deployment scenario simply requires additional radios to handle the separate frequency – most other equipment is the same. If the 5G NR RAN carries significantly more traffic, operators may need to add additional baseband capacity to provide the additional processing power needed.

With Ericsson Radio System, there is no need to change any radio equipment: existing equipment can be reused, including baseband units and radios.

Figure 10: Case 1, NSA 5G deployment with 4G and 5G in same bands.

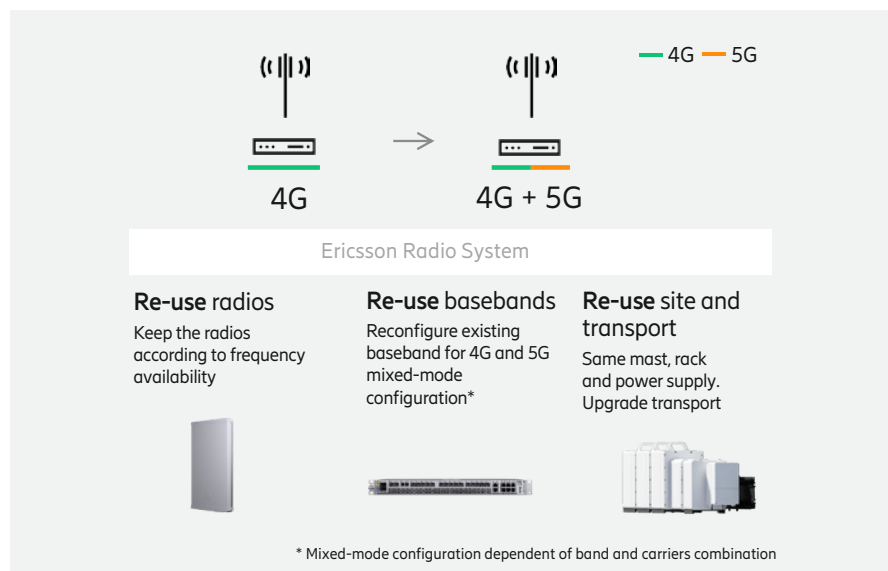

* Mixed-mode configuration dependent of band and carriers combination

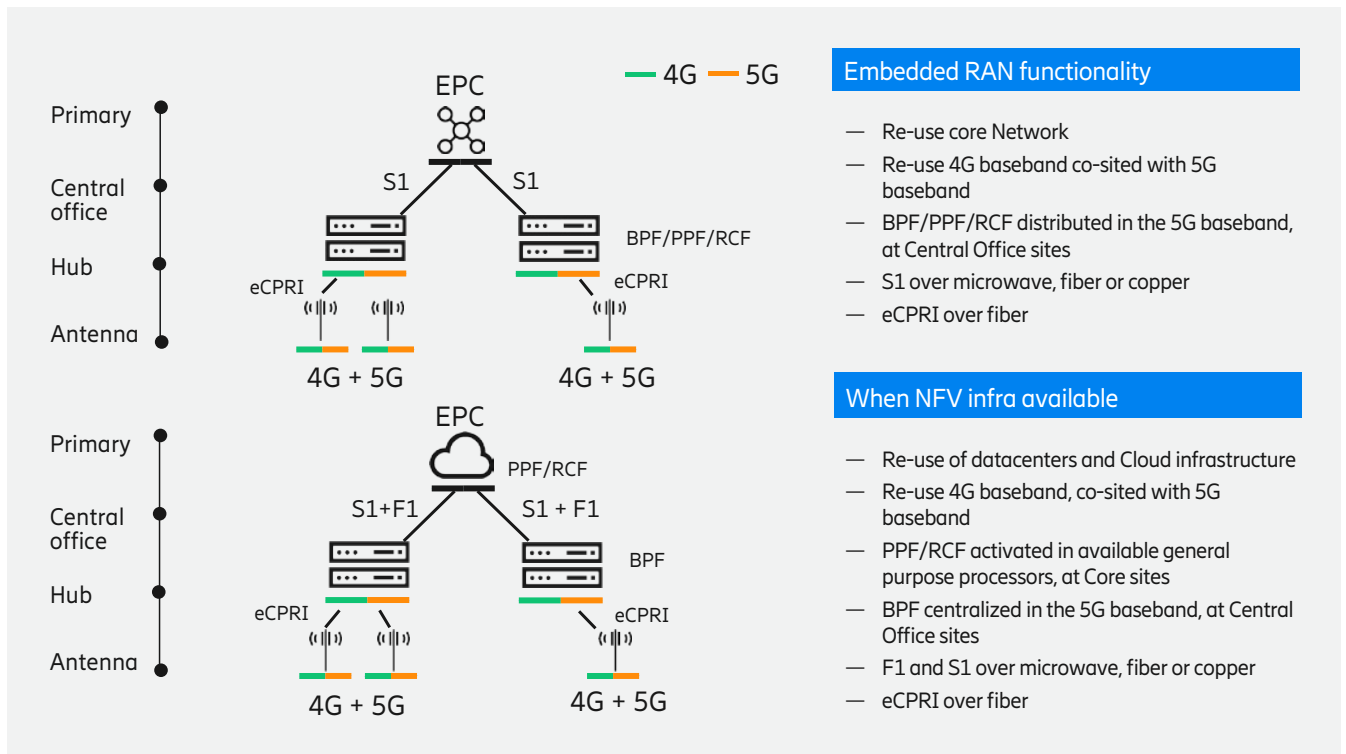

Figure 11: NSA 5G co-located deployment, with or without centralized RAN.

Figure 11 shows NSA 5G deployed co-located with either distributed or centralized RAN architecture. In traditional distributed RAN (D-RAN) architecture, the baseband units are in the same location as the antenna.

With centralized RAN (C-RAN), the baseband units are moved to a central location. Baseband capacity is pooled in typically one central office per city, with several hub sites, with a low-latency, high throughput fiber fronthaul network connecting antenna sites using either CPRI or eCPRI (we foresee eCPRI and legacy CPRI coexisting for some time).

This can cut baseband sites by a factor of 5–10, maximizes baseband utilization and enables power saving at night, for example, by powering down unneeded units. Centralized RANs also simplify maintenance.

The next step could be to virtualize parts of the RAN to make use of the same cloud infrastructure as the core network, if available in a suitable location, by splitting control and user planes across network layers. Instead of being handled in the baseband units, the Radio Control Function (RCF) and user plane Packet Processing Function (PPF) are activated in available general-purpose processors in the core network.

In the Virtual RAN (V-RAN), these control and user plane functions are split using the F1 interface. There will be advantages to this when 4G and 5G are physically separately located, as operators can use a common management system and devices can be connected to different sites (for uplink and downlink). However, with 4G and 5G co-located there is little to gain from virtualization as interworking between 4G and 5G is an intra-site affair.

Case 2 – NSA 5G, with 4G in low/mid bands and 5G in high bands

In Case 2, 4G is deployed in low frequencies, while NSA 5G is deployed in high frequencies, meaning that 5G cell coverage areas will be smaller than those of 4G, especially for the uplink. Some operators will want to deploy 5G in this way to gain the significant new capacity and extremely high throughput (a few Gbps) that the wider spectrum in higher-frequency bands provides.

While it may be possible to co-locate most 4G and 5G radios, some new sites will be needed outside the existing site grid (in between existing 4G sites) to achieve contiguous coverage, as shown in Figure 12. 5G radios are still anchored in 4G, and existing core and transport network assets are reused. Use cases include enhanced MBB, and FWA in selected areas.

As these sites are typically completely new sites, all hardware is new and used only for 5G. However, it is possible to add 4G to the new sites, at limited additional cost, to provide better overall MBB experience. This is because 4G–5G interworking is improved when 4G is deployed within the new site (with multimode baseband units).

Case 3 – SA 5G in low, mid or high bands

In Case 3, SA 5G is deployed in a combination of low, mid and possibly high bands. 5G radios will be deployed as stand-alone units with dedicated connectivity to a core network fulfilling the new 5GC specifications, which means this solution will be available later than NSA 5G. We expect to see operators deploy SA 5G initially in low bands, as well as mid and possible high bands, in order to provide larger coverage areas.

In addition to serving enhanced MBB and FWA use cases, SA 5G deployments are likely to be used for new use cases, such as private or enterprise networks and industrial (critical) IoT, in ‘self-contained’ factory or campus environments, in any suitable band.

In the longer term, it’s likely that all 5G deployments will support SA as well as NSA, with interworking options between low, mid and high bands being just as important for SA 5G.

The same principles around centralized and virtualized RAN apply to SA 5G as to NSA 5G. Operators are free to introduce centralized and virtualized RAN capabilities whenever they make sense; they are not tied to the introduction of new radio technology or spectrum.

Some operators may want to distribute the core execution environment in order to ensure content delivery performance, typically lower latencies, through locating the user plane part of the packet core close to the access network.

Many SA 5G radios will be physically co-located with 4G sites, as they can still reuse the existing physical resources and transport network.

Figure 12: Case 2, NSA 5G deployment with 4G in low/mid bands and 5G in high bands.



5G-ready radio, core and transport networks

Operators need to decide now on their cell site/antenna strategy to be 5G ready. Ericsson's recommended approach is to build out Gigabit LTE as fast as needed and then gradually upgrade to 5G through planned installations and software upgrades for 5G – gradually moving NR further out into network. This helps ensure a high-quality, consistent user experience during the implementation of 5G.

To help operators achieve this, Ericsson offers an end-to-end 5G Platform, across radio, core and transport networks.

Adaptable radio system

Many components of the Ericsson Radio System are already 5G-ready, requiring just a software installation in order to handle 5G NR. We have also introduced systems that enable smooth evolution from 4G to 5G, using existing infrastructure and site grid as much as possible.

One example is our baseband portfolio, which has been 5G-ready since 2015. This means our operator customers have already been able to start planning and deploying baseband and radio systems in preparation for 5G. These 5G-ready baseband units have additional processing headroom to cater for 5G, and are software upgradable to handle 5G coding schemes and subcarrier settings.

The baseband units are suitable for both NSA and SA implementations. In NSA 5G, with LTE as the common carrier, devices are anchored in LTE (from resource handling point of view), and LTE system steers devices to attach to LTE or NR. The same baseband units can be used for SA 5G. As 5G NR grows, operators will likely need more baseband processing capacity, especially as additional frequencies are deployed (modulation, coding scheme, carrier spacing all need to be adapted).

Ericsson Elastic RAN enables dynamic scaling by using a group of basebands, which interwork seamlessly with each other over fiber connections up to 6 km apart. This is useful for coordination and carrier aggregation between different cells (with different baseband units). When operators implement 5G, they need even more coordination, for example between two different 5G cells.

Another useful software feature for evolving 4G to 5G is dynamic spectrum sharing, which enables deployment of 5G in the same spectrum as 4G. For example, operators could use 1,800 MHz with 4x4 MIMO for both 4G and 5G, and enable a natural shift of resources from 4G to 5G over time.

This will be very useful for implementing 5G in low/mid bands (700, 900, 1,800 and 2,100 MHz spectrum), where operators can dynamically transfer open LTE carriers to

NR and back. The switch between LTE and NR only takes milliseconds and, because it is dynamic, minimizes spectrum wastage.

As most operators are expected to implement NSA 5G first, 4G/5G dual connectivity will also be a useful feature in handling the transition from 4G to 5G. For example, one cell at a base station could be 5G NR (in 2.1 or 3.5 GHz); a 5G device will camp on the 4G band and use dual connectivity on the 5G NR downlink. The device display will show '5G', and so this capability offers a fast and effective way to achieve early nationwide 5G coverage.

Ericsson Elastic RAN enables dynamic scaling by using a group of basebands, which interwork seamlessly with each other over fiber connections up to 6 km apart.

As most NSA 5G deployments will make use of the existing site grid and equipment, operators need to consider how best to install the massive MIMO active antennas needed for 5G. Many operators currently have two antennas on each mast (high and low bands), so one solution is to free up space for the new antenna by combining existing bands in a new multi-mode antenna being developed by Ericsson.

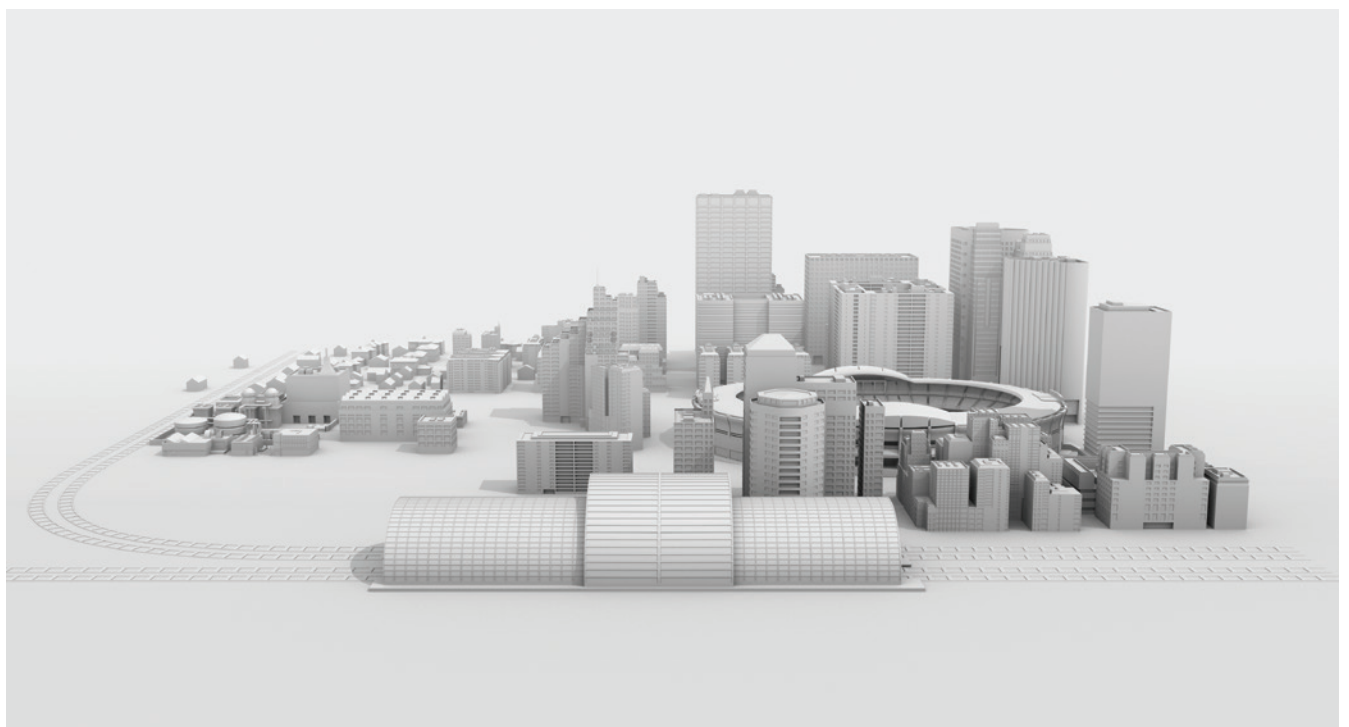

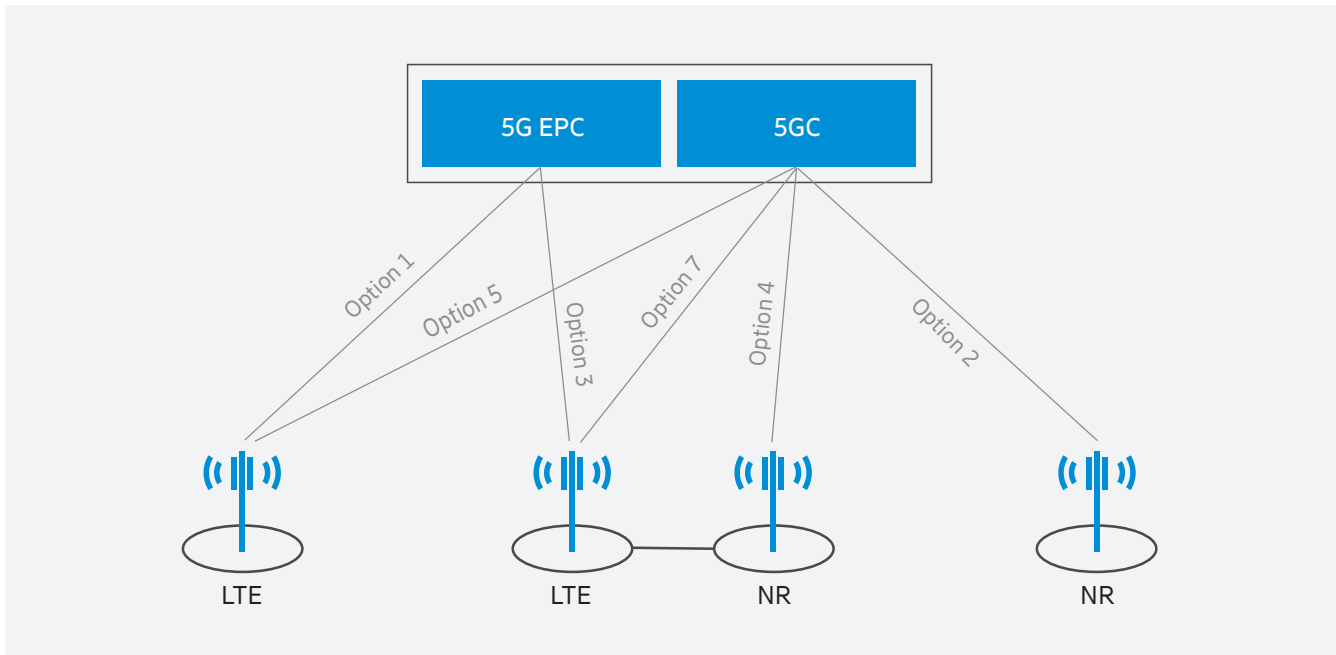

Figure 13: Ericsson will offer a dual-mode core network including 5G EPC and 5GC functionality as a common solution.

Flexibility in the core

Ericsson's core network offering includes the 5G EPC supporting NSA 5G NR delivering end-to-end 5G use cases. Initial versions of this core network connected to 5G NR radio has been trialed with multiple leading tier-one operators for early end-to-end 5G evaluation. This enables operators to roll out and capture new growth opportunities immediately for 5G and IoT services for both consumers and enterprises.

Ericsson's 5G EPC operates independently of access type, and enables interconnection with all services to whatever resources they need – meeting different requirements for each use case in terms of latency, battery life or usage, and data rates, for example. This core network supports 3GPP Option 3 (NSA), where NR devices are anchored in an LTE cell.

The 5G EPC can further optimize the capabilities for each service through network slicing. These virtual network instances on shared infrastructure are logical networks with tailored feature sets and topology for each service, which would be more expensive to build as separate networks.

The core network solution will also be upgradable to a 5G Dual-Mode core also supporting the 3GPP-defined 5GC functionality, which can connect any device over any radio deployment (LTE and/or NR), including Option 2 for SA NR.

The 5GC architecture is Service Based Architecture (SBA), which enables fast new service creation and extensibility, using software-based APIs to efficiently configure and connect core network functionality. The Ericsson 5G Dual-Mode Core solution targets data center deployment based on state-of-the-art cloud-native software. Specific attention is given to resiliency, capacity scaling in both directions (up/down), a high degree of automation support to significantly simplify operations, and deployment flexibility.

In terms of service capabilities, the 5G Core network offers a range of new service enablers. It enables a single device to simultaneously connect to multiple network slices. For example, in a car, this would mean the same connection can be used for web browsing, M2M communications, road safety and traffic information – all of which have very different requirements.

Other features include the enhanced service differentiation, such as limiting access to certain geographic areas for FWA, improved and simplified QoS, and enhanced support for edge computing since a device can simultaneously access both local and centralized networks within a single connection. It will also enable support for devices without SIM cards, and supports operators' strategic ambition to converge 3GPP and non-3GPP access technology support (including fixed access).

Ericsson's approach is to develop a 5G dual-mode core network supporting both 5G EPC and 5GC functionality in a common solution, as shown in Figure 13. This will enable operators to serve both existing (LTE) and new (NR) devices with enhanced services as needed, with efficient and dynamic use of resources across the two modes, as the device fleet changes over time.

Operators can also add a management orchestration layer, and Software Defined Networking (SDN) virtualization capabilities to further enhance their offerings. In addition to enhanced MBB, operators will have the flexibility to create and roll out new use cases, leveraging network slicing and orchestration of virtualized resources.

More integrated backhaul and fronthaul

Ericsson's transport network solutions are evolving in sync with RAN evolution to offer higher backhaul and fronthaul capacity and new capabilities, including improved latency where needed, with tight integration between the two. Transport capacity requirements will vary greatly throughout the RAN, from fiber-like capacity needs in dense city and urban areas to much lower needs in rural areas.

Ericsson is evolving its transport solutions in three key areas: microwave backhaul, routing and fronthaul solutions.

We are ensuring operators can evolve their existing microwave backhaul networks to support 5G needs, with higher capacity, new bands and improved automation.

Ericsson has also developed a range of smaller, purpose-built routers that will meet operator needs precisely, and more efficiently, by supporting only the needed protocols, providing best balance of latency, buffering and capacity for different use cases – while also supporting policy-driven automation and vertical slicing in both 4G and 5G.

For operators with centralized RAN deployments, Ericsson offers high-performance (high-capacity, low-latency) fronthaul solutions, with the flexibility to use fiber or microwave to meet the need for tighter radio coordination, short time-to-market and low operating costs.

Conclusion

As operators develop their strategies for 5G roll-out, Ericsson offers an end-to-end 5G Platform, across radio, core and transport networks. This is designed not only to enable operators to evolve to new 5G capabilities at the speed that matches their own business models, but also to protect and enhance existing 4G capabilities by reducing risk and making best use of current infrastructure.

We are also helping operators manage the complexity of operating interworking 4G/5G networks, addressing multiple use cases, through new automation and management tools in areas such as service-based architecture and software defined networking.

Over time, Ericsson will continue to augment its systems with new functionality and capabilities to enable new, more advanced and capable use cases and business models.

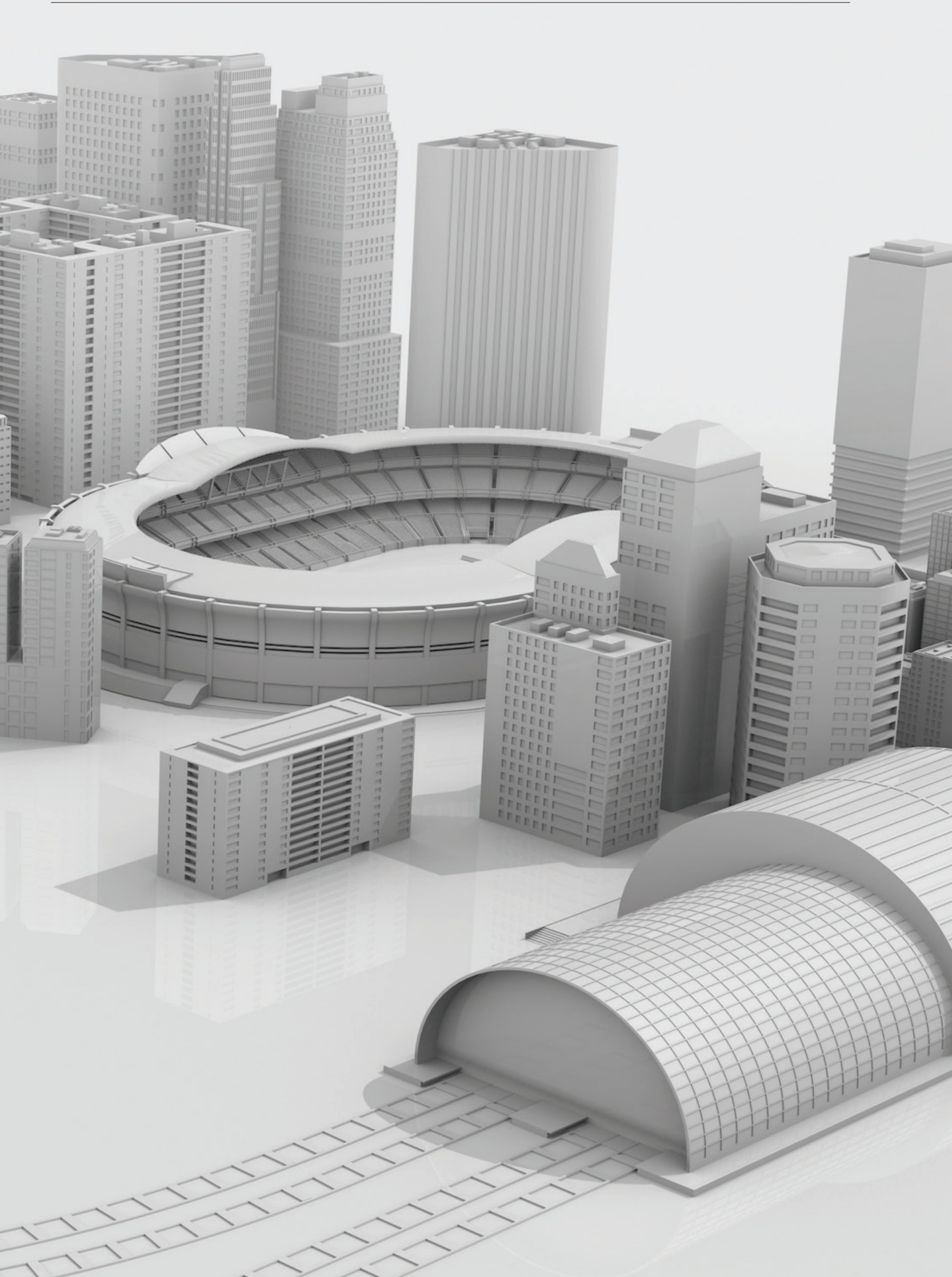

Ericsson enables communications service providers to capture the full value of connectivity. The company portfolio across Networks, Digital Services, Managed Services and Emerging Business is geared to make our customers more efficient, go digital, and find new revenue streams. Ericsson's investments in innovation have delivered the benefits of telephony and mobile broadband to billions of people around the world. The Ericsson stock is listed on Nasdaq Stockholm and on NASDAQ in New York.

www.ericsson.com