

Ericsson GSM R10 Training Package



Mikael Spante

Product Manager, Education
Ericsson Global Services
mikael.spante@ericsson.com

Introduction

- The training package is supporting the Ericsson GSM R10 system
- The training package offers clearly defined yet flexible training paths to target specific technical and business staff within your organisation
- The training package uses blended learning – from traditional classroom teaching to learning off the web

Why invest in the Ericsson GSM R10 Training Package?

- **Faster time to revenue**

“You can secure an rapid competence build-up, enabling an early commercial GSM launch.”

- **Cost efficiency**

“With competent and skilled staff, you will have a well-performed network, improving productivity and profitability.”

- **Increased performance/less churn**

“With competent and skilled staff, you will ensure high quality of service, leading to higher end-user satisfaction and competitiveness.”

- **Minimal risk**

“Your competent and skillful staff will be able to help you in maintaining a cost effective organization.”

- **Organizational effectiveness**

“Your staff will become more motivated through competence development and learning culture, which ensure you an effective organization for long-term success.”

GSM Core Network

- Delta Training -

AXE 810 Delta Training (FAB 102 1310)

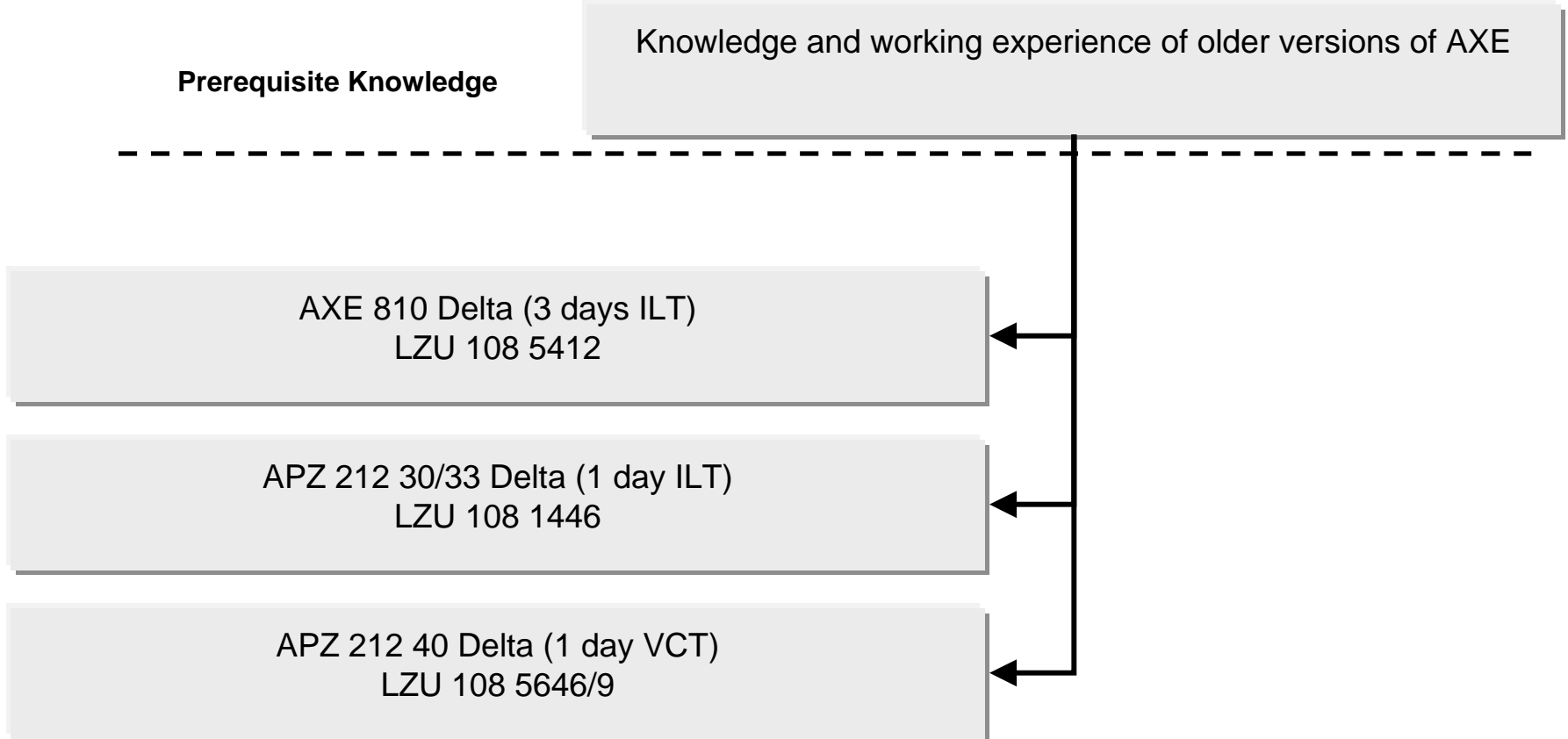

GSM Core Network Delta Training (FAB 102 1311)

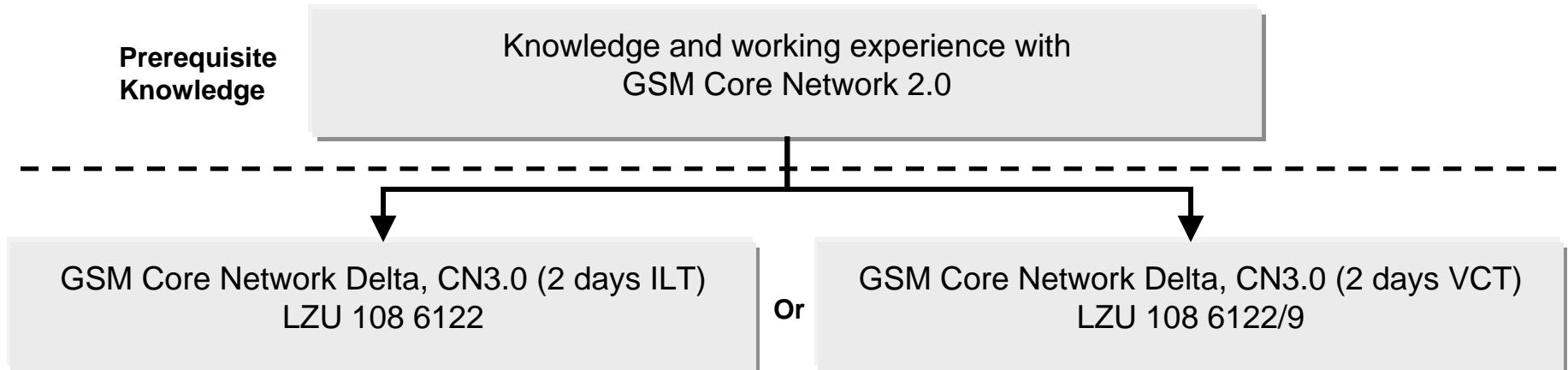

GSN Delta Training (FAB 102 1432)

**Prerequisite
Knowledge**

Knowledge and working experience of older versions of GSN

GSM SGSN 5.0 Delta, Hands-On (2 days ILT)
LZU 108 6192

OSS RC Delta Training (FAB 102 1378)

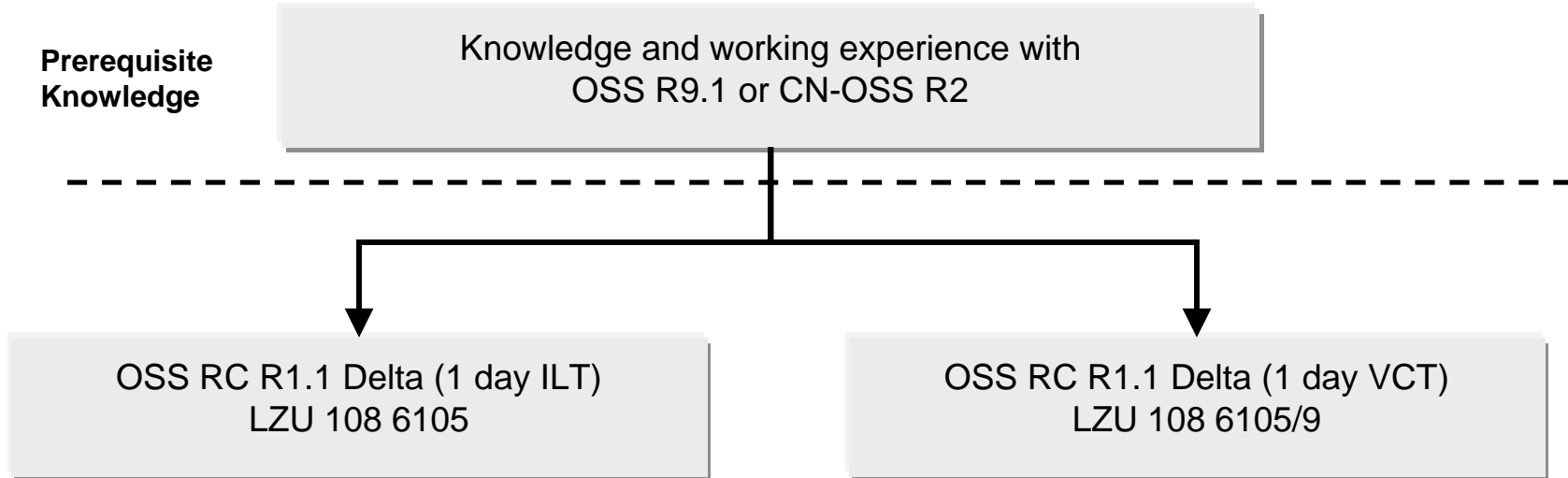

GSM Network

- Fundamentals -

Introduction to IP Networks, WBL (FAB 102 1313)

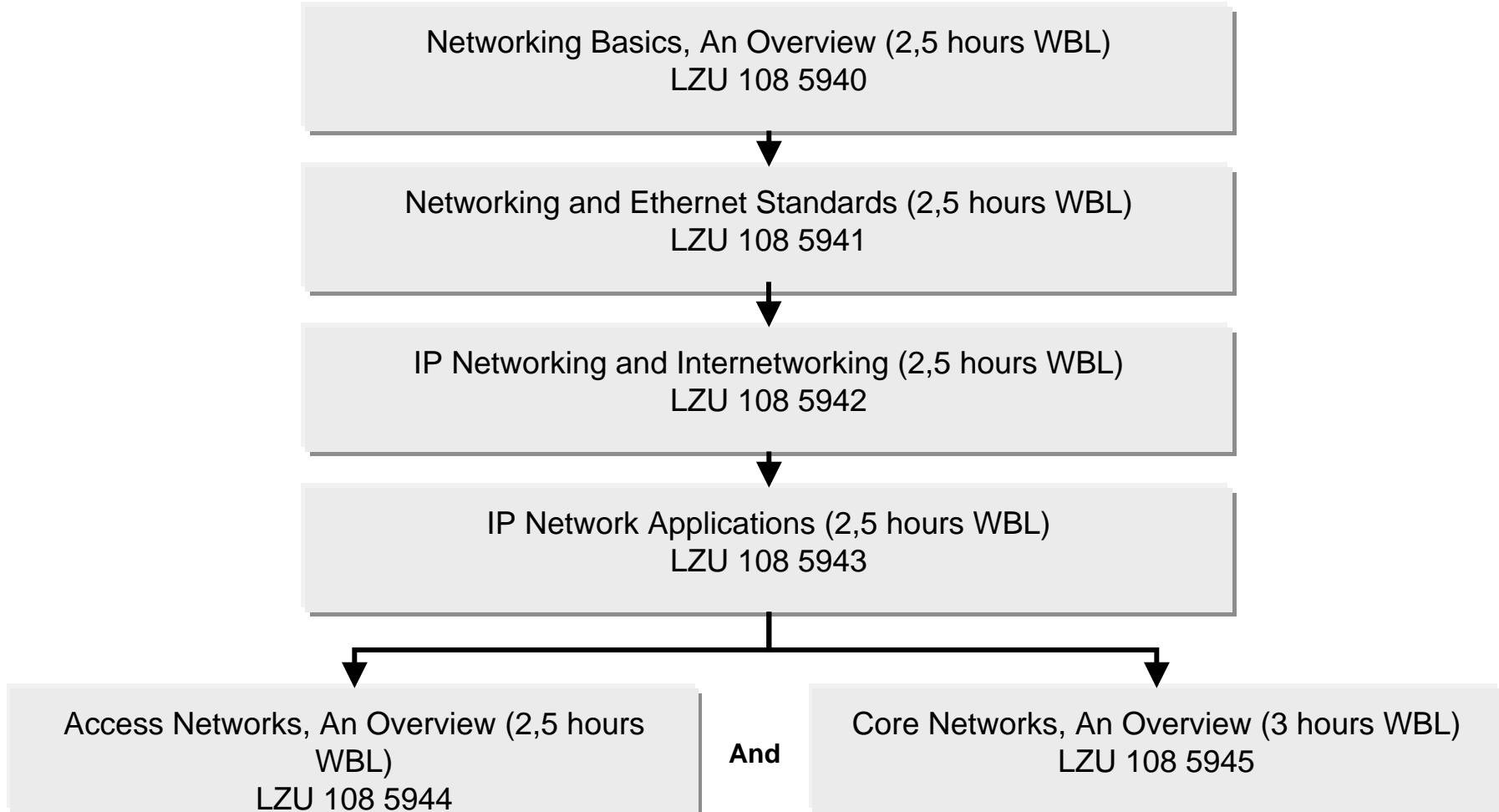

IP Fundamentals (FAB 102 1314)

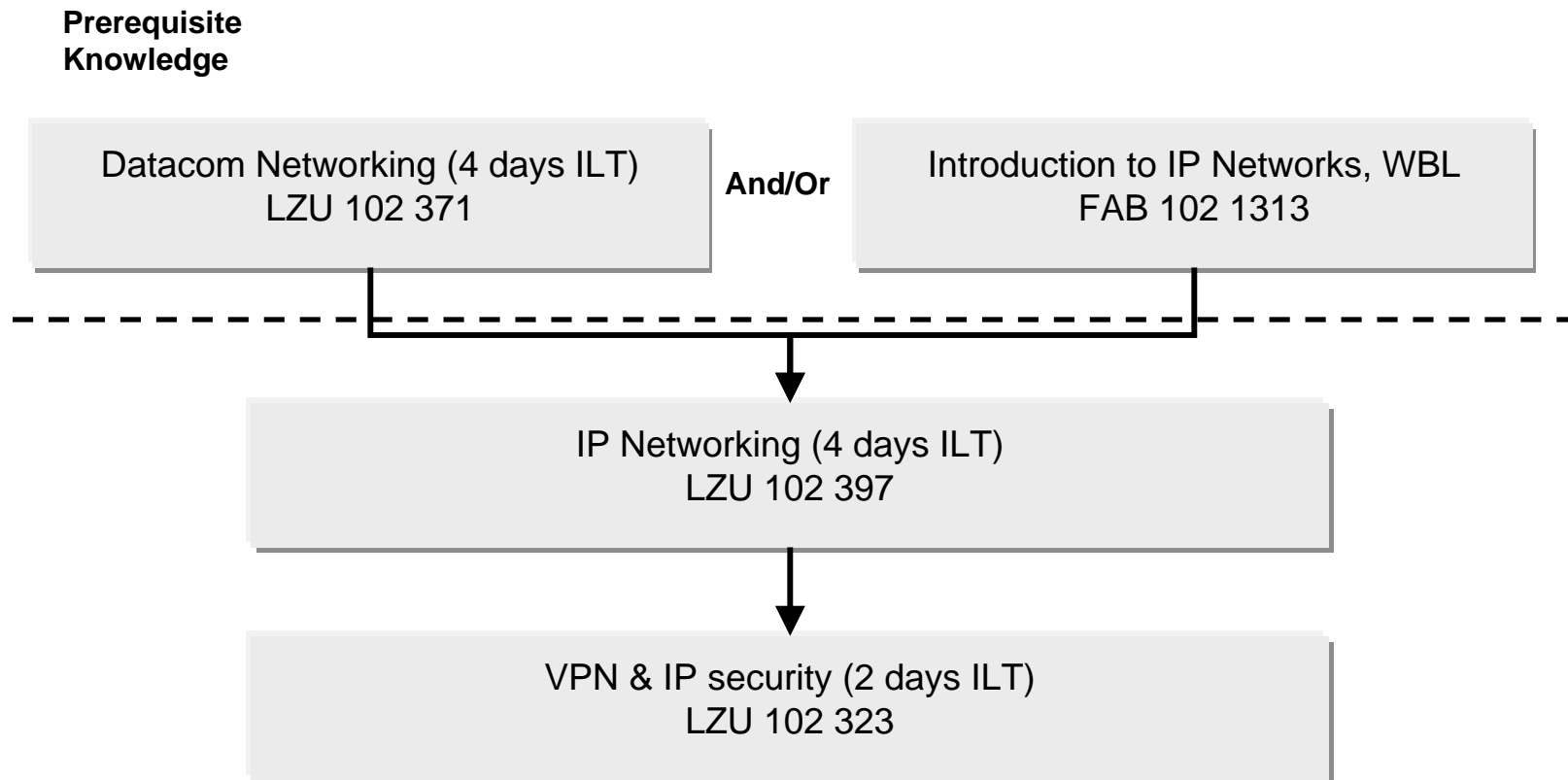

IPv6 Fundamentals (FAB 102 1383)

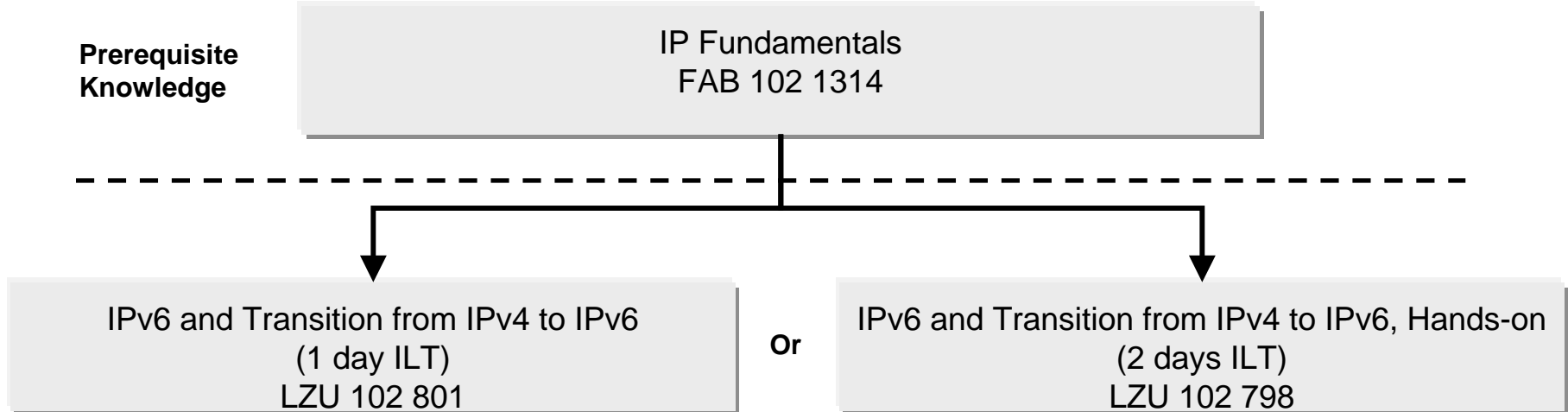

IPv6 Routing Configuration (FAB 102 1384)

**Prerequisite
Knowledge**

IPv6 Fundamentals
FAB 102 1383

IPv6 Routing Protocols (2 days ILT)
LZU 102 796

IPv6 Advanced Network Configuration (FAB 102 1385)

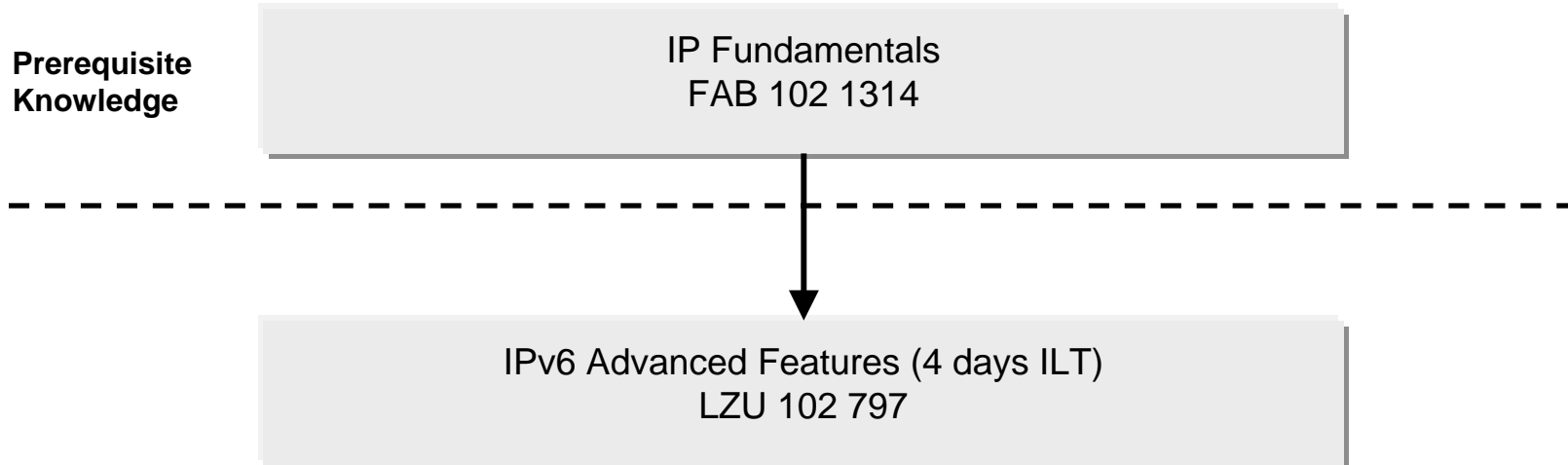

ATM Fundamentals (FAB 102 1315)

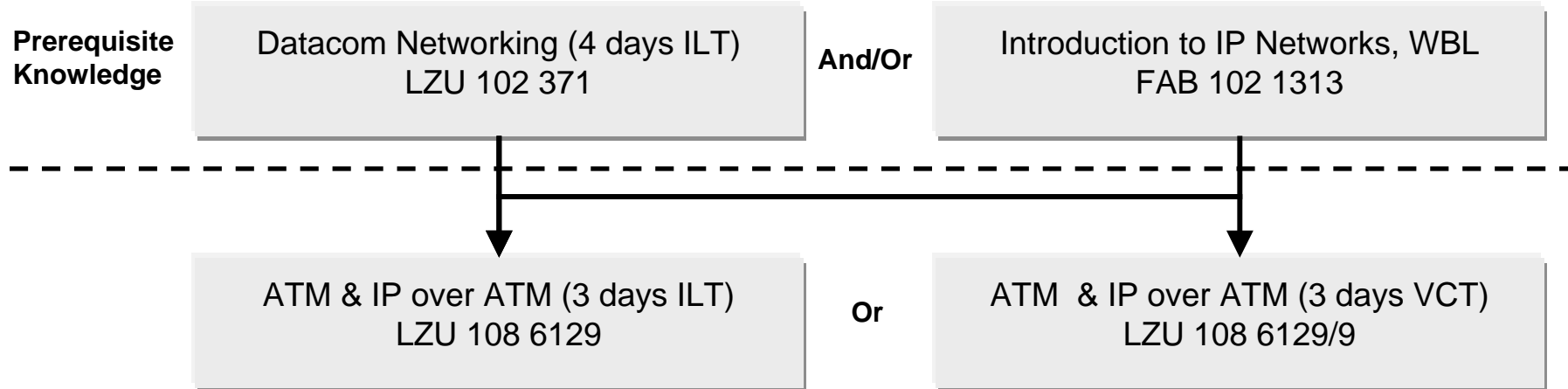

GSM Network Fundamentals, Blended Training (FAB 102 1317)

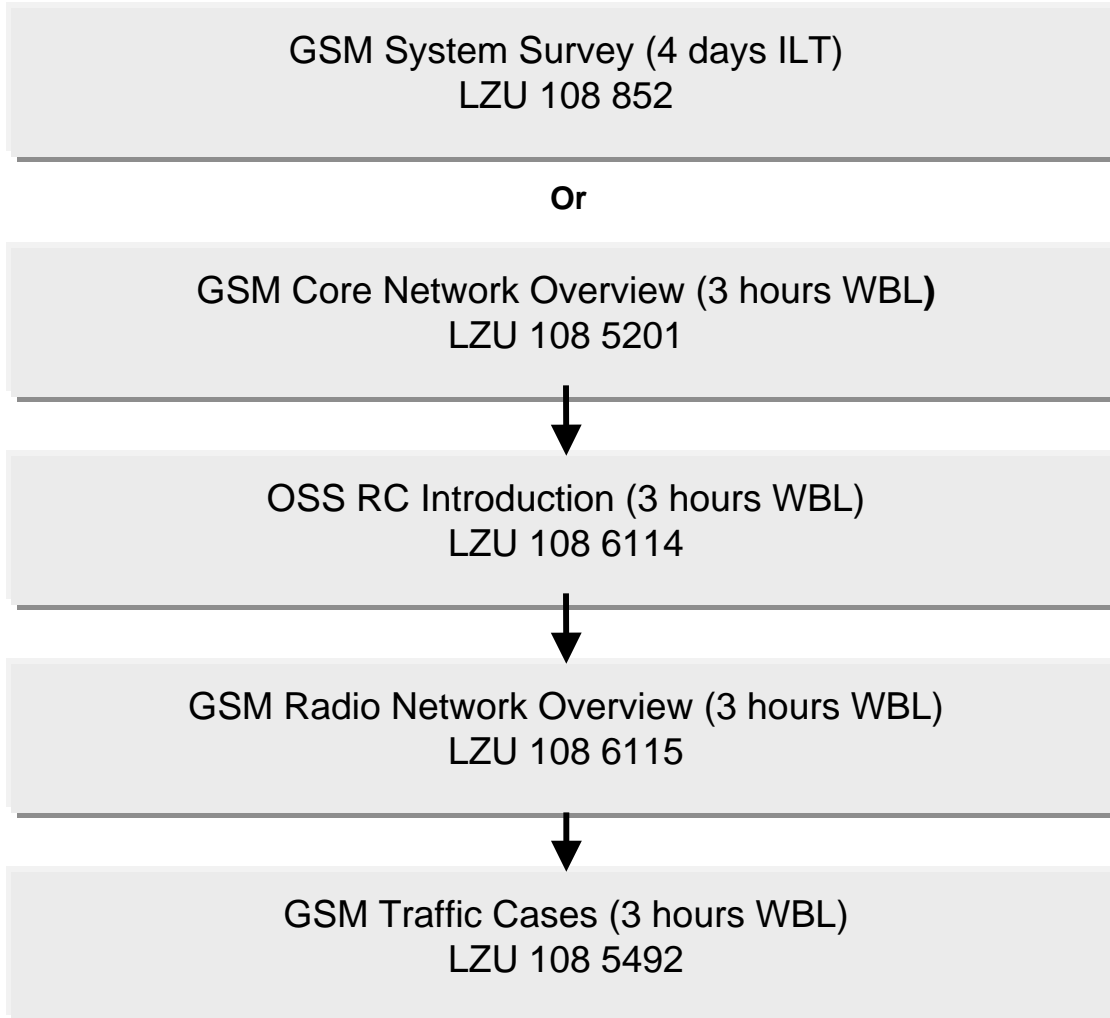

GPRS Fundamentals (FAB 102 1382)

GPRS System Survey (2 days VCT)
LZU 108 876/9

Or

GPRS System Survey (2 days ILT)
LZU 108 876

GSM Core Network

- Field Maintenance -

GSM Core Network Maintenance (FAB 102 1318)

Prerequisite Knowledge

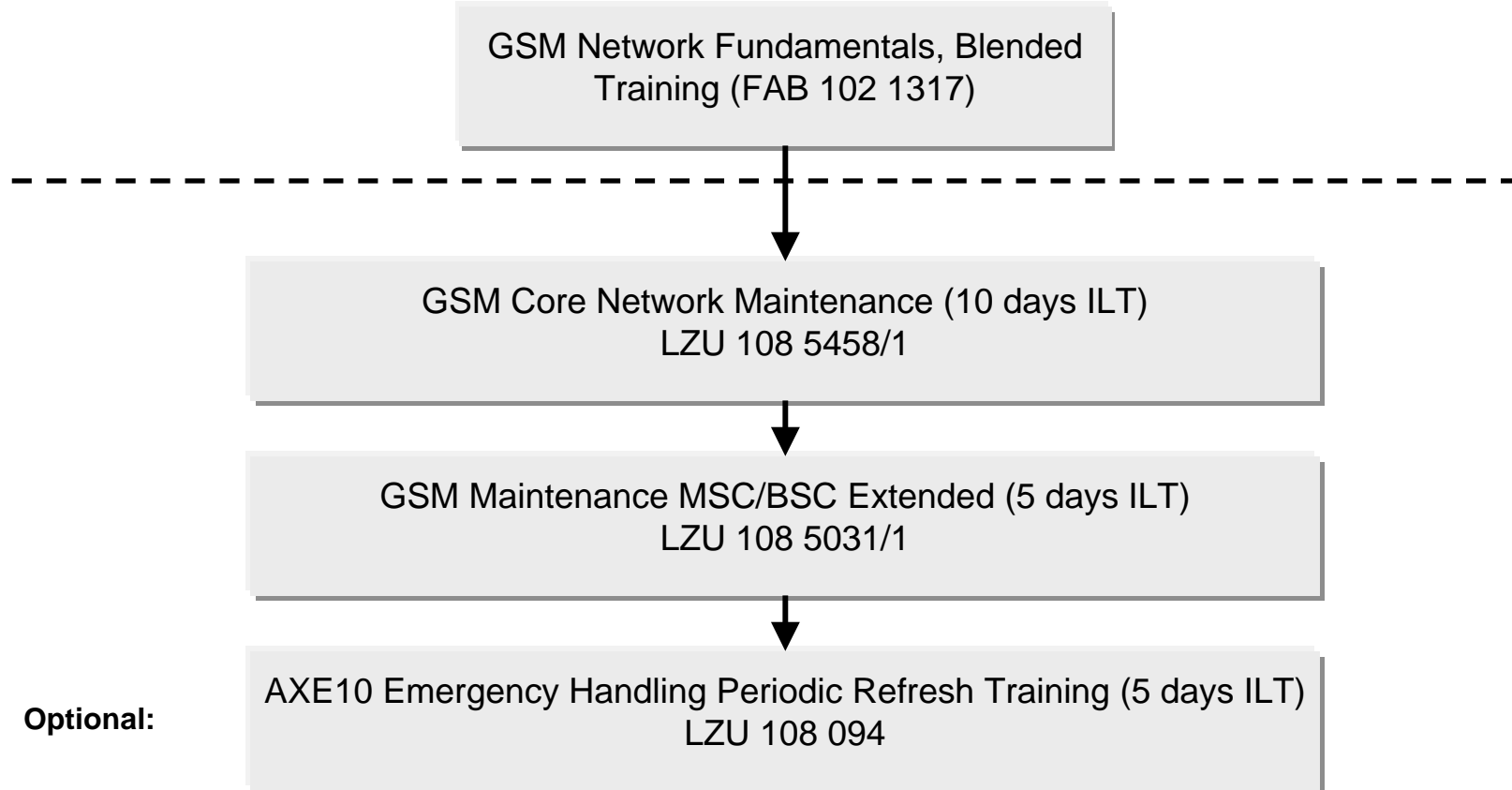

GSM Core Network

- Network Operation and Configuration -

GSM Core Network Surveillance (FAB 102 1319)

Prerequisite Knowledge

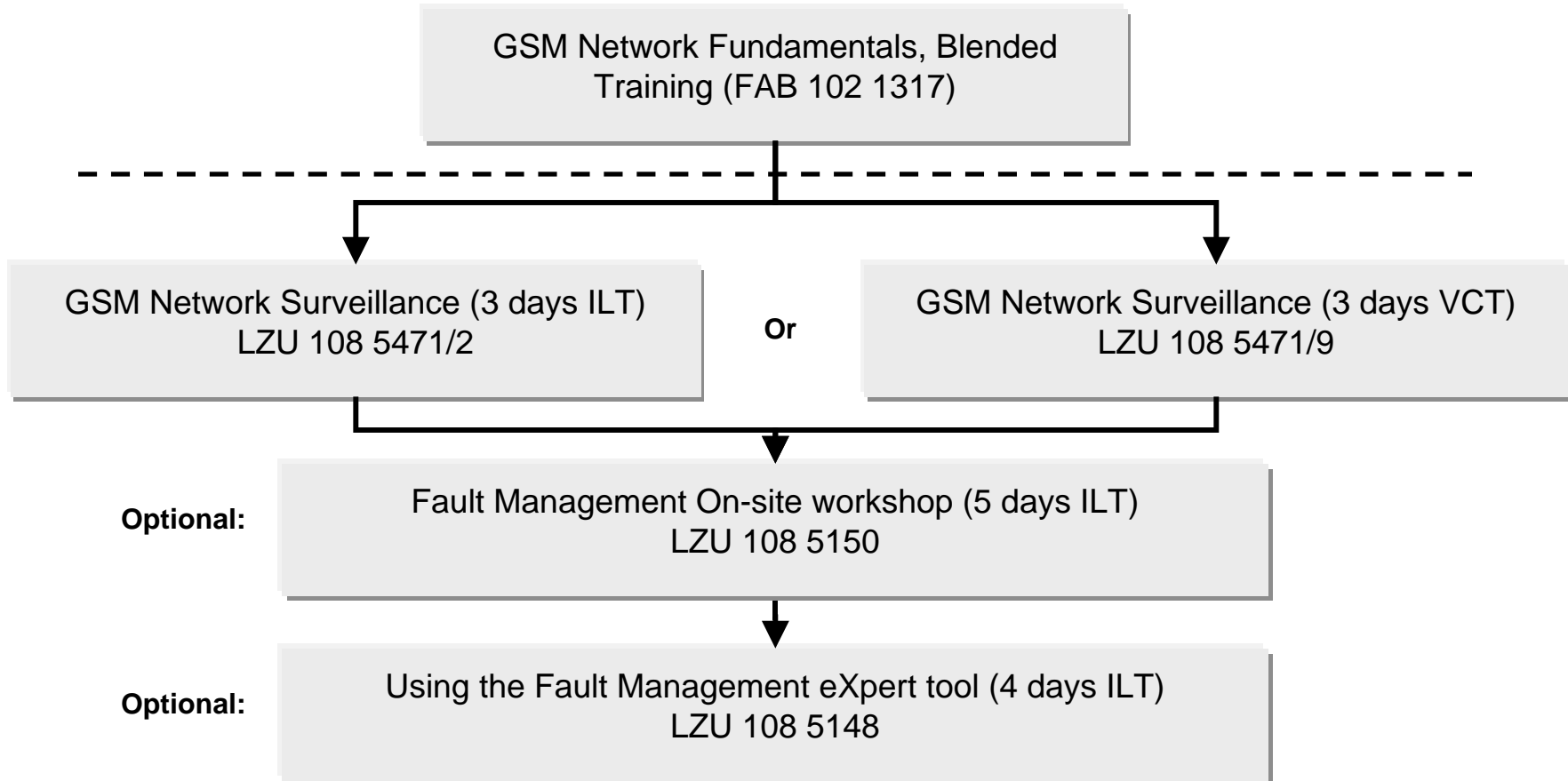

APG 40 Operation and Administration (FAB 102 1345)

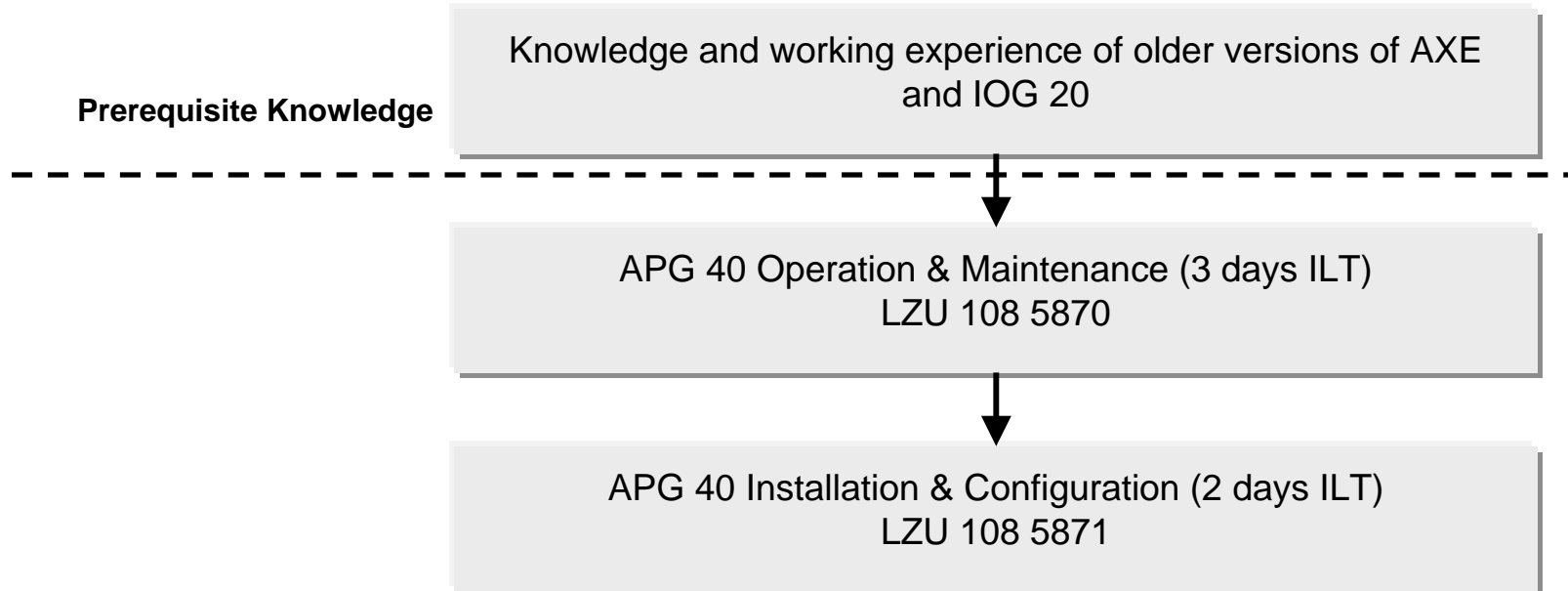

GSM MSC/VLR Operation & Configuration (FAB 102 1320)

Prerequisite Knowledge

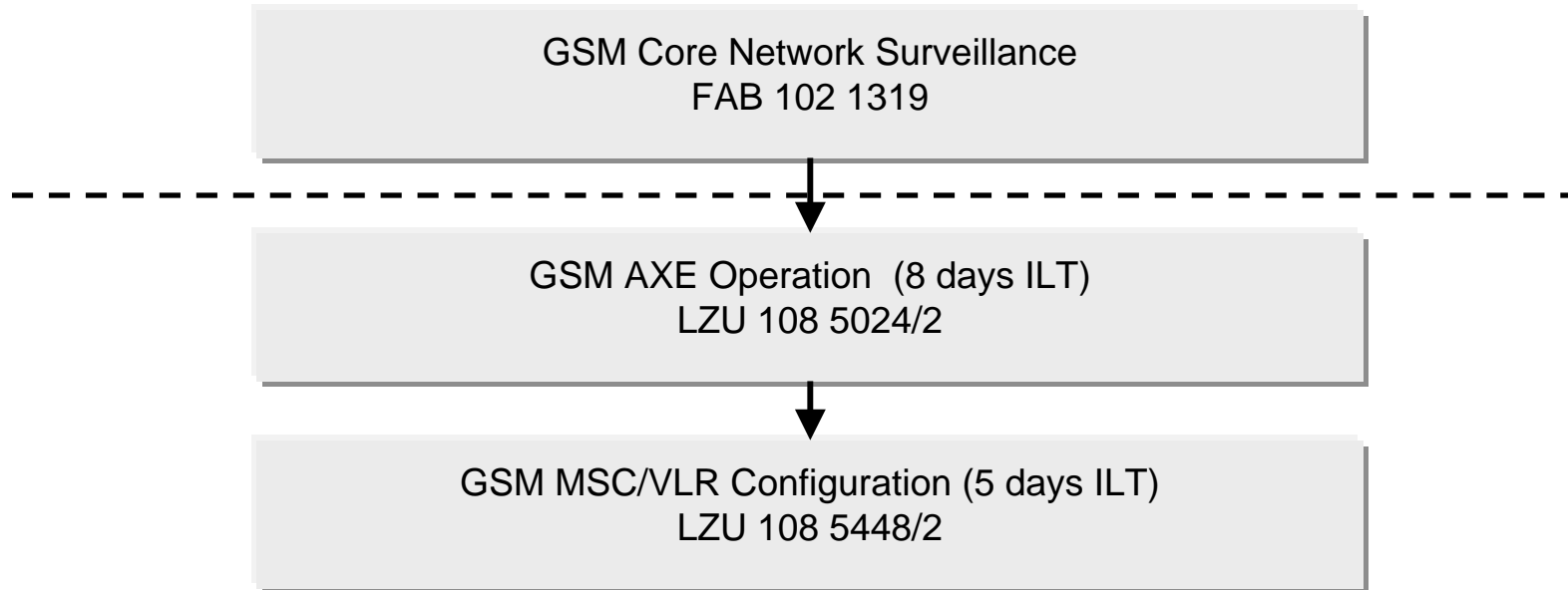

GSM User Database & Authentication Operation (FAB 102 1321)

Prerequisite Knowledge

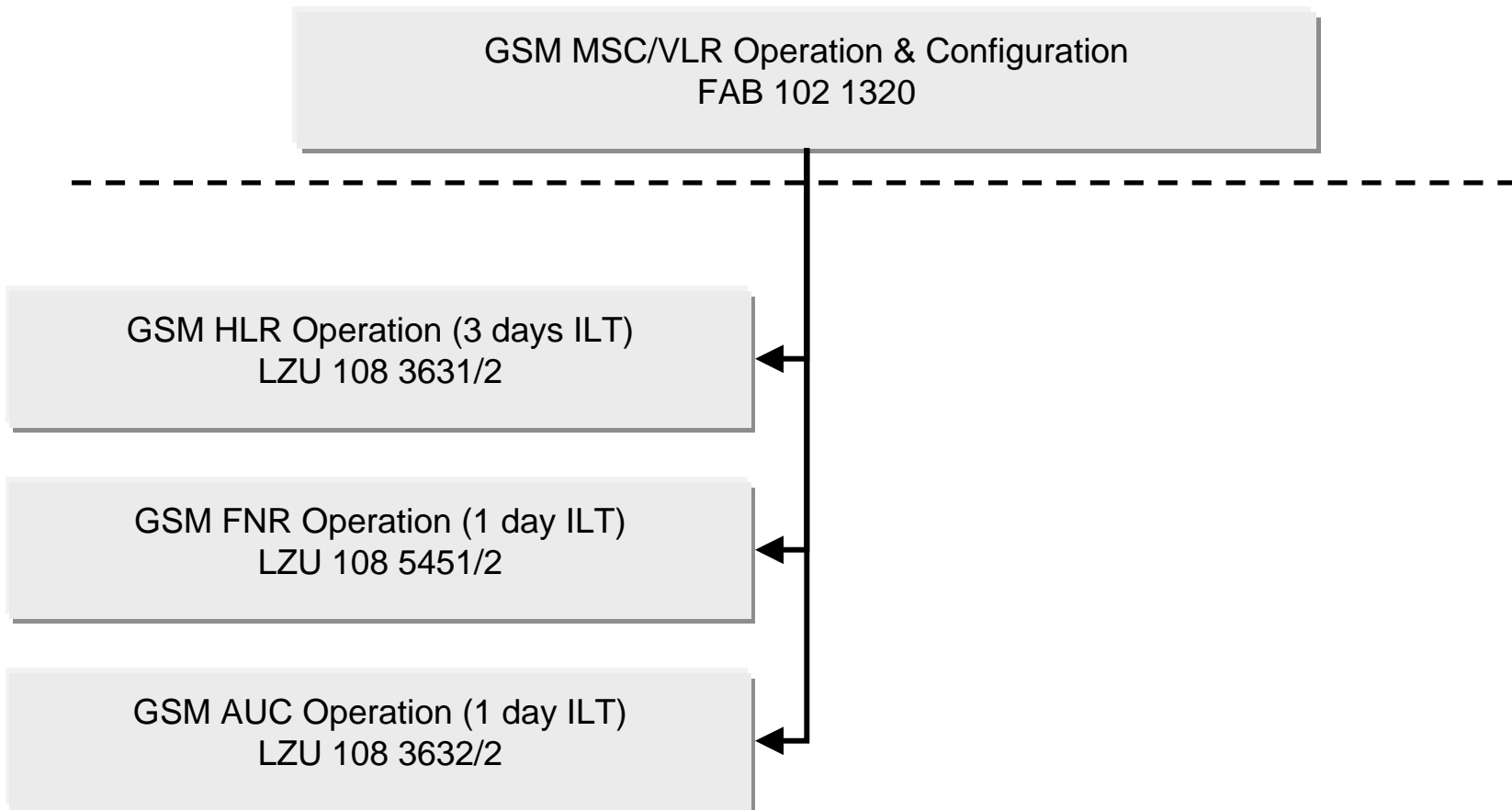

GSM Core Network Advanced Operation (FAB 102 1322)

Prerequisite Knowledge

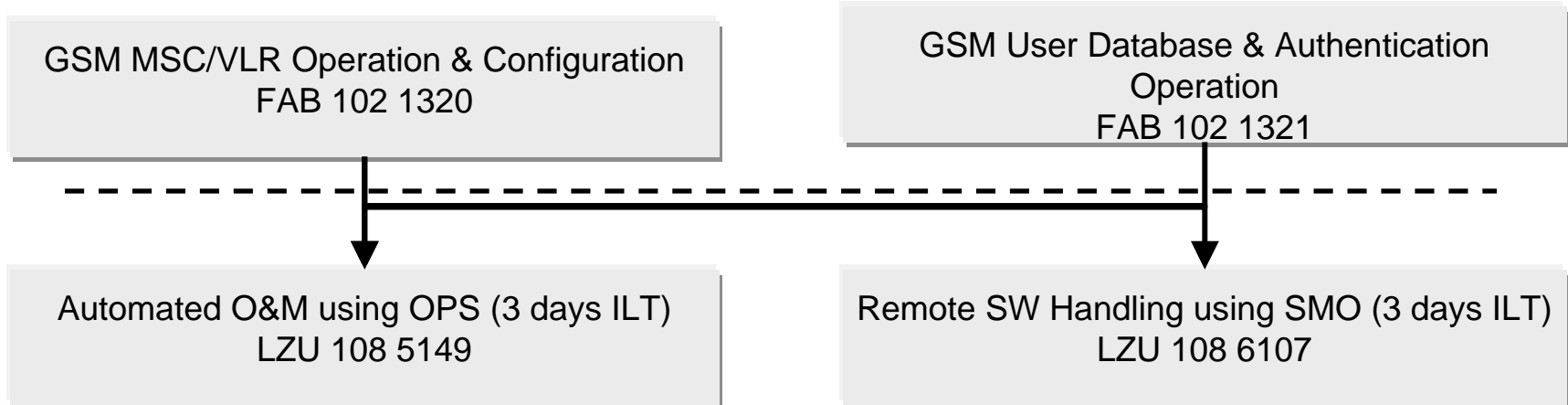

GSM Media Gateway Operation & Configuration (FAB 102 1324)

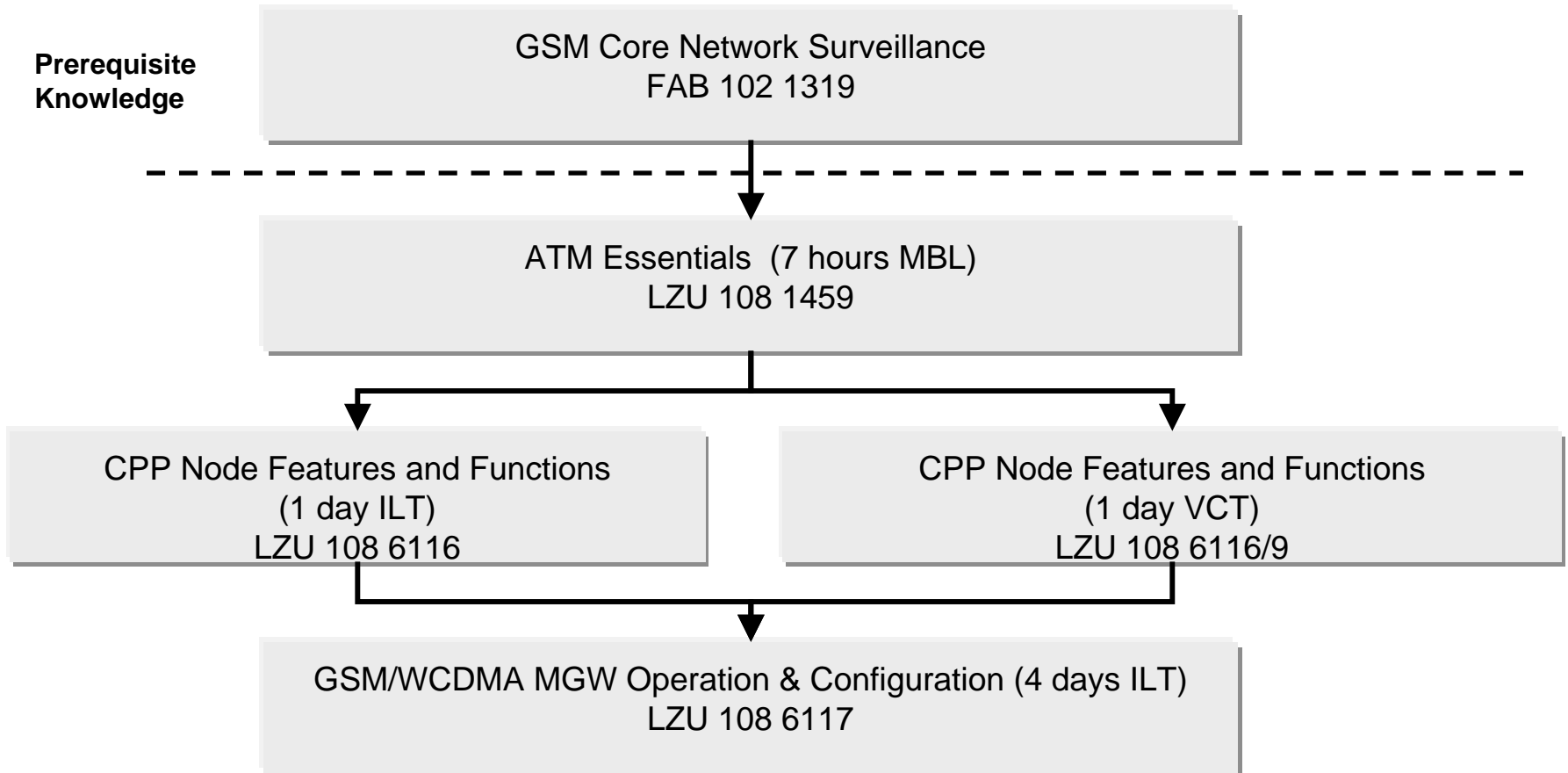

GSM GSN Operation (FAB 102 1356)

Prerequisite Knowledge

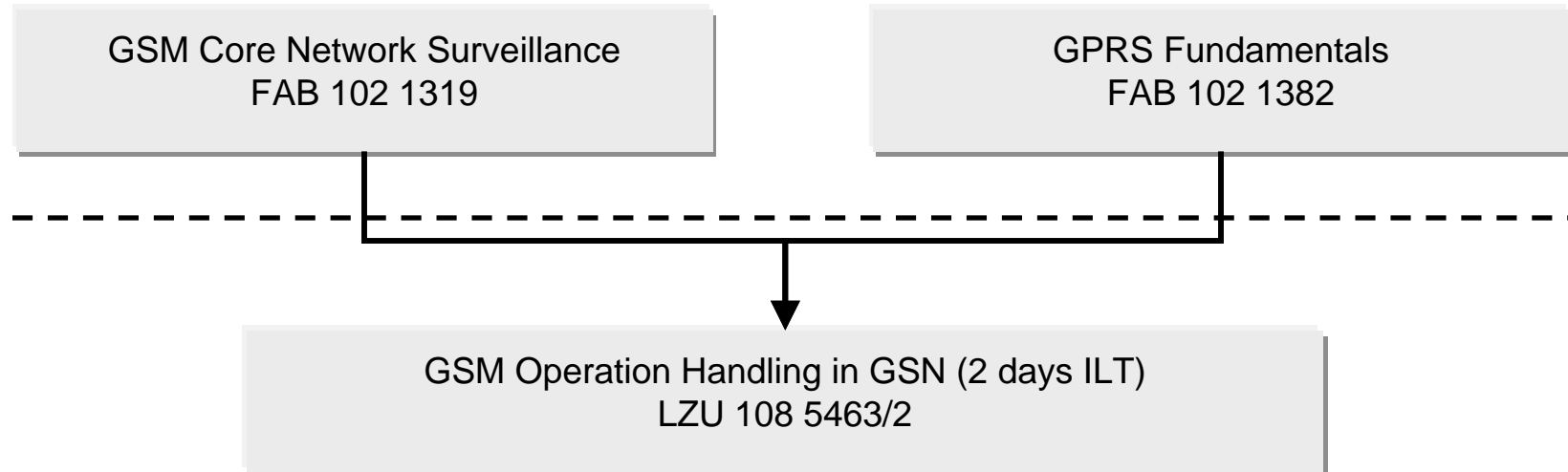

GSM GSN Configuration (FAB 102 1357)

Prerequisite Knowledge

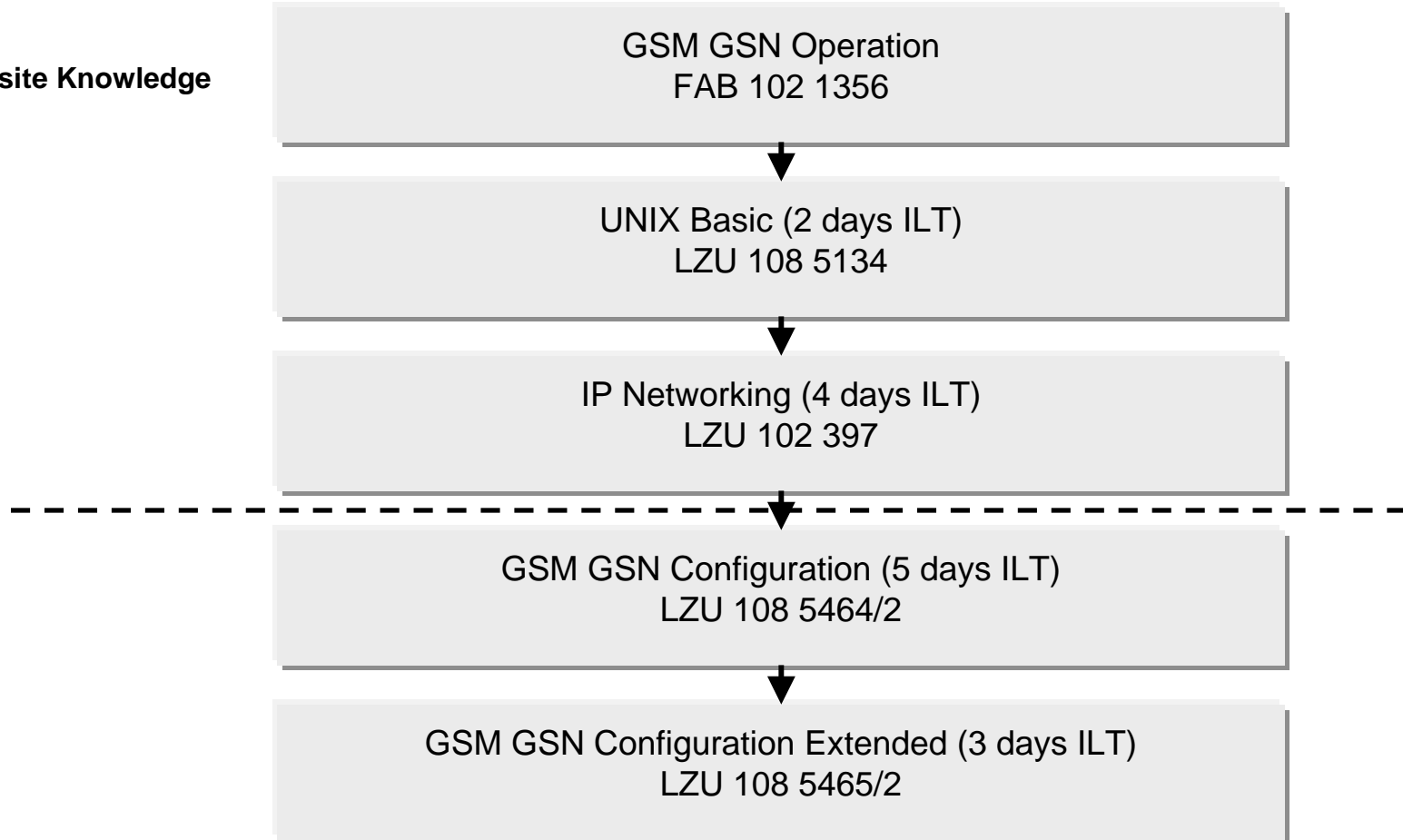

GSM GSN System Administration (FAB 102 1358)

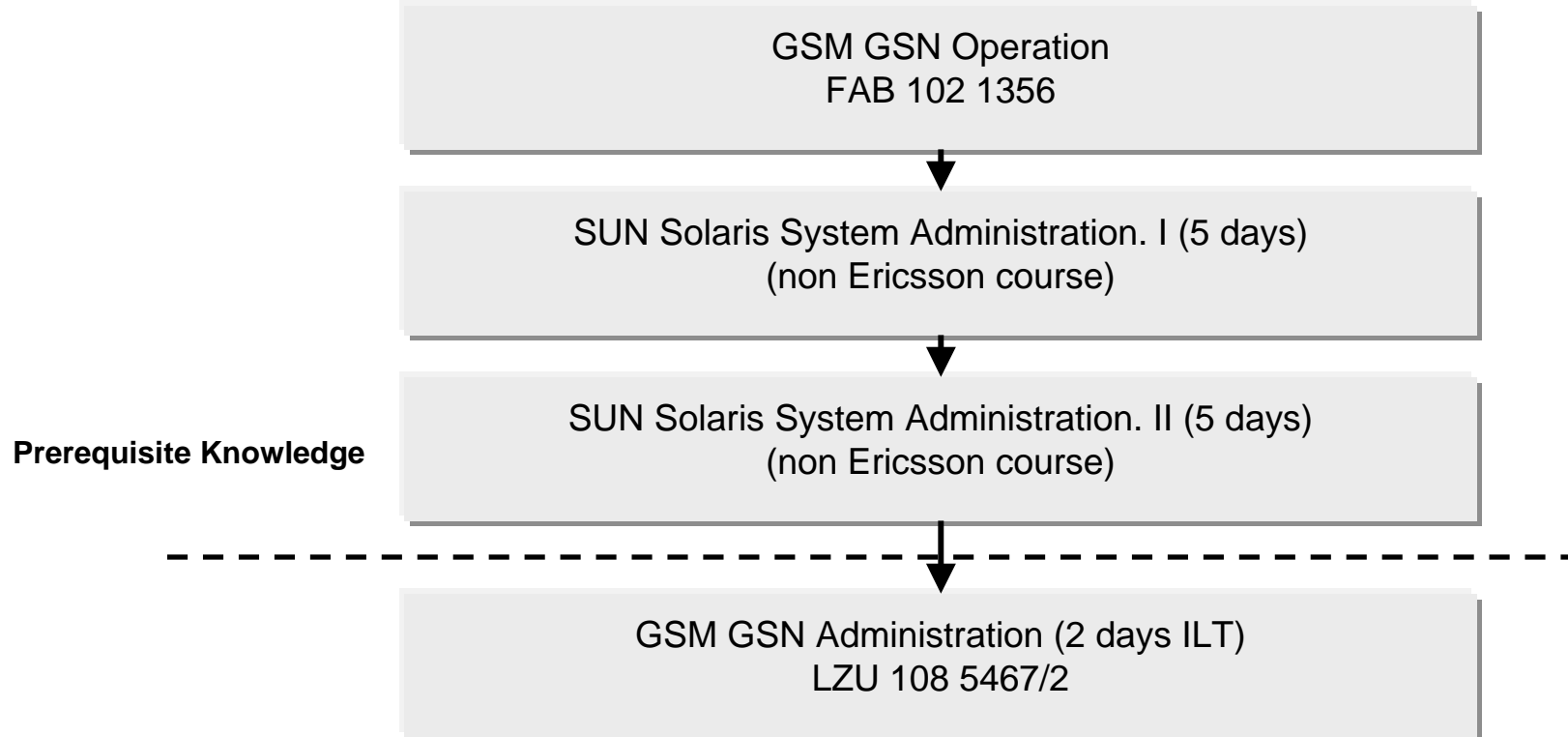

GSM GSN Trouble Shooting (FAB 102 1359)

Prerequisite Knowledge

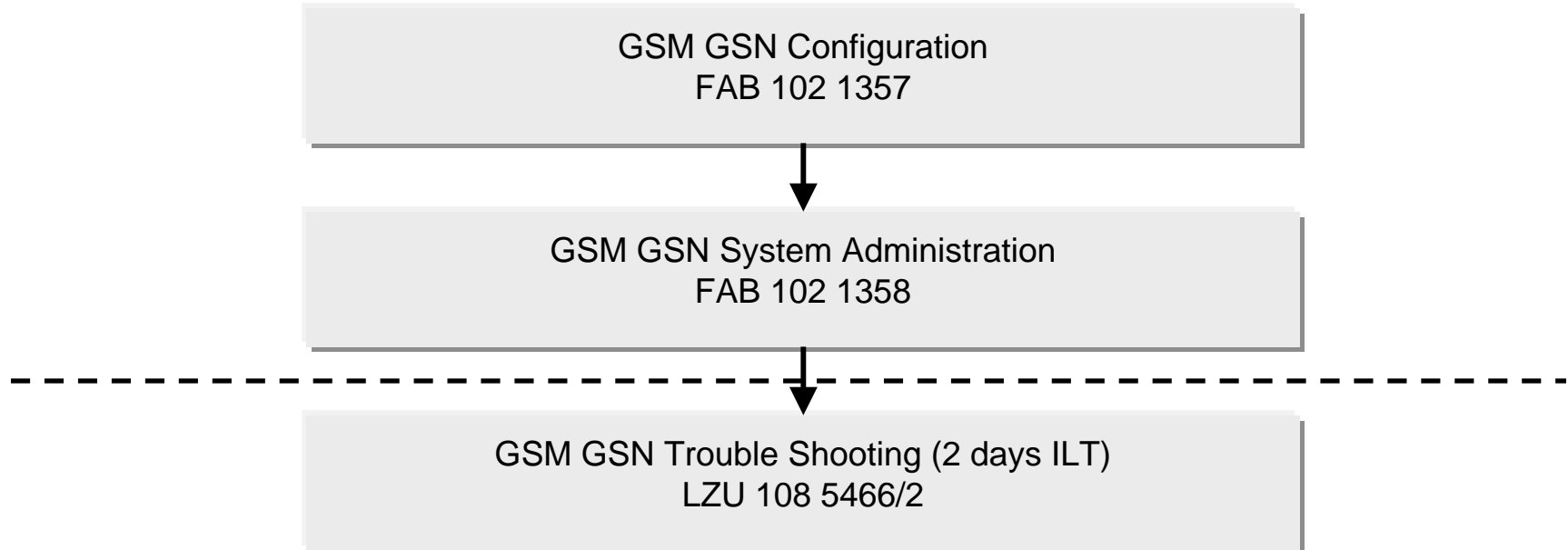

J20 GGSN Configuration (FAB 102 1360)

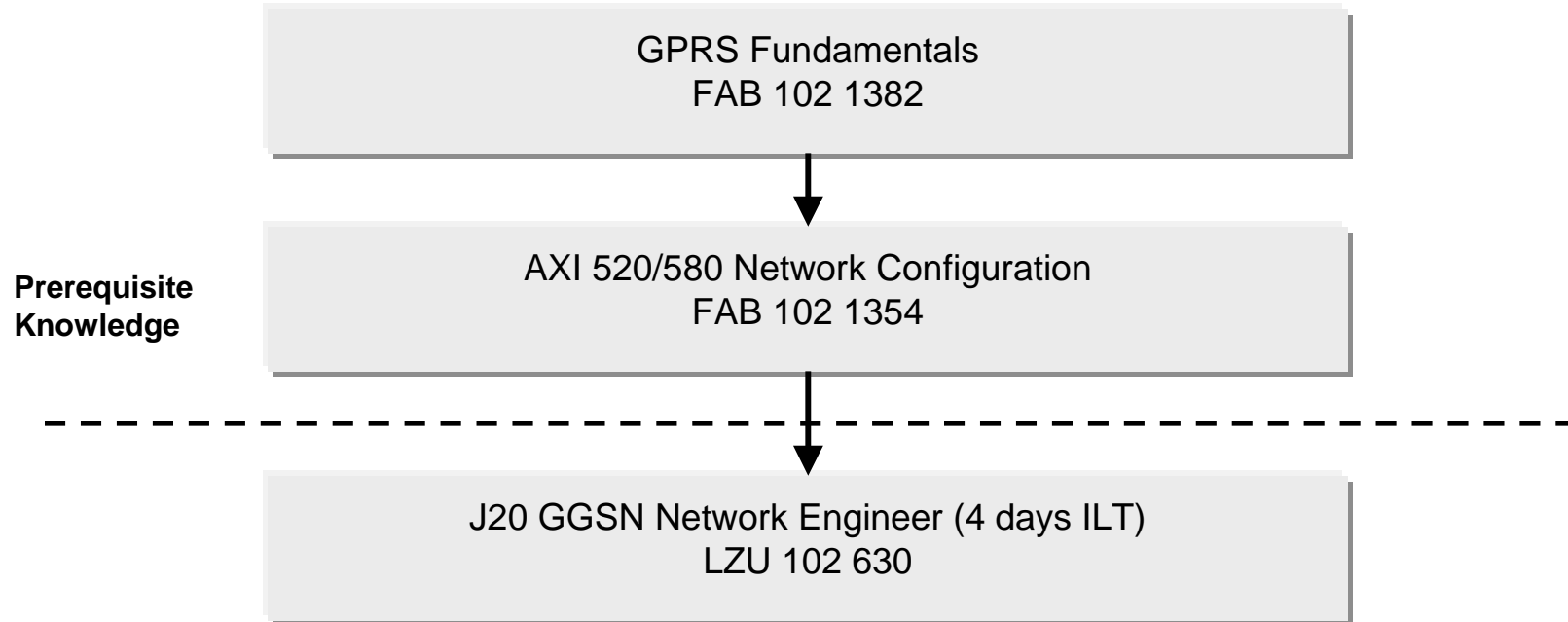

GSM Core Network Advanced Configuration (FAB 102 1323)

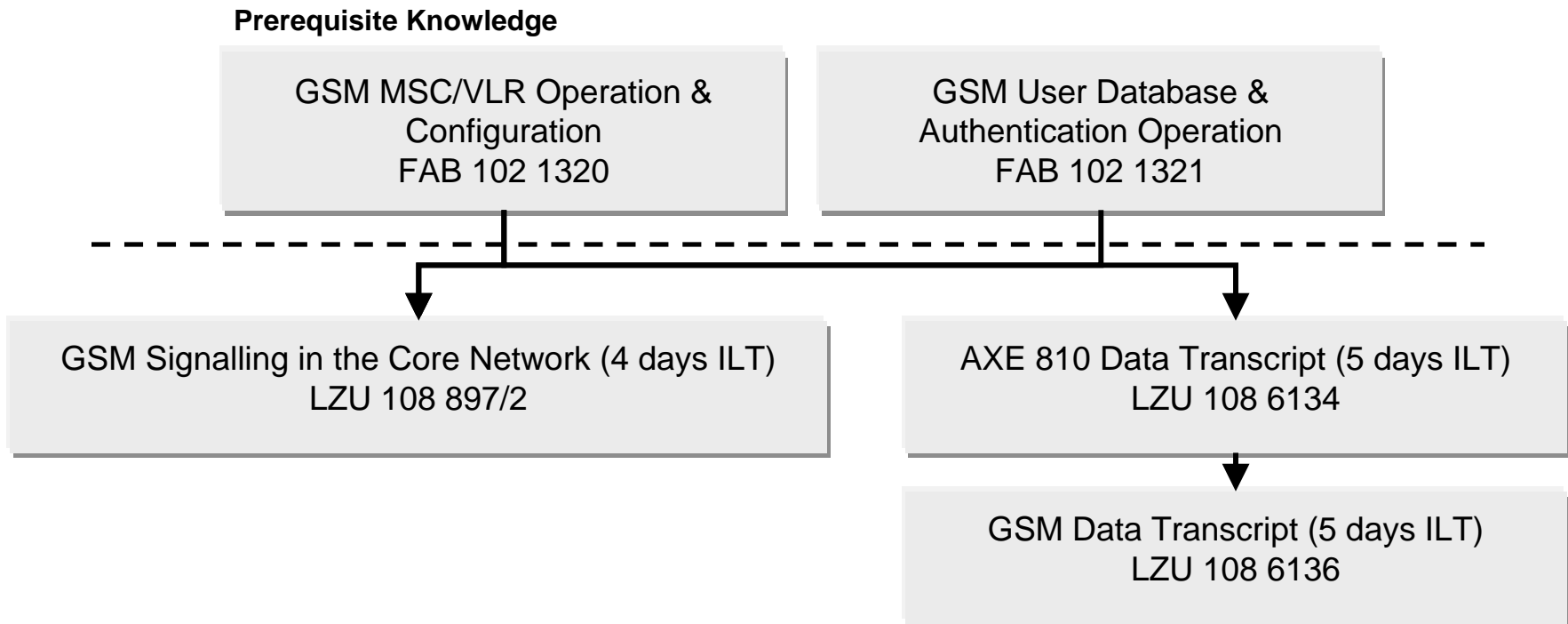

GSM Core Network Integration (FAB 102 1352)

Prerequisite Knowledge

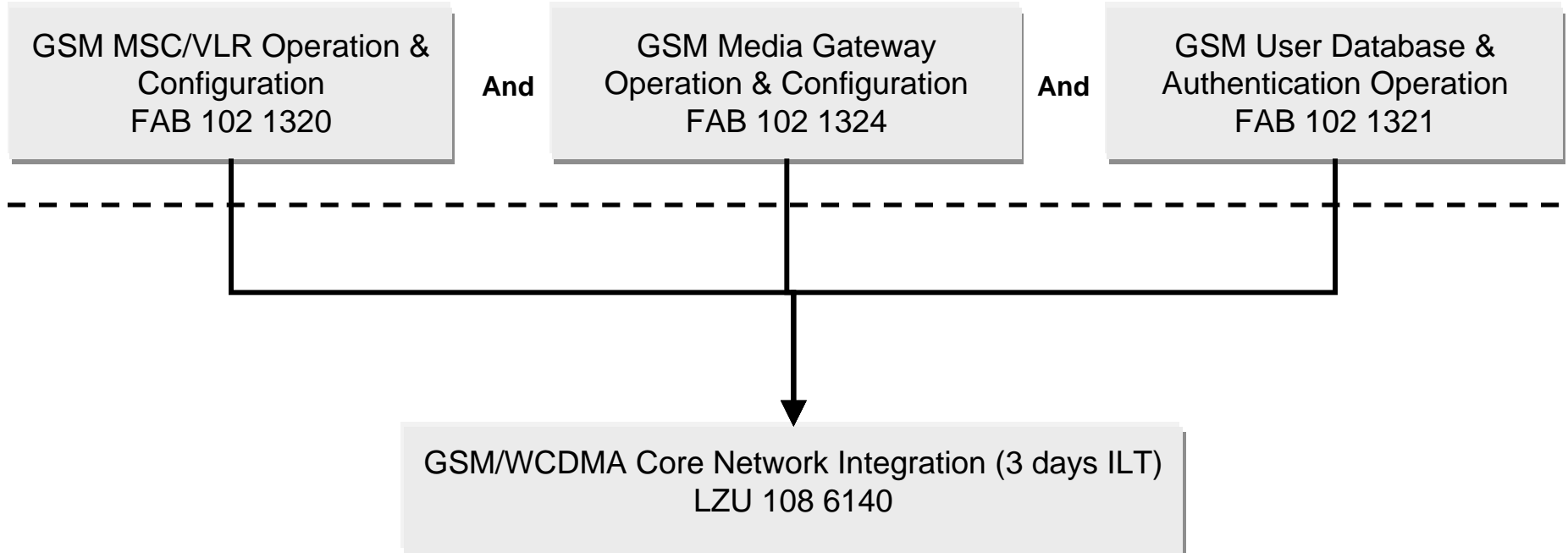

GSM/WCDMA Core Network Charging Operation (FAB 102 1351)

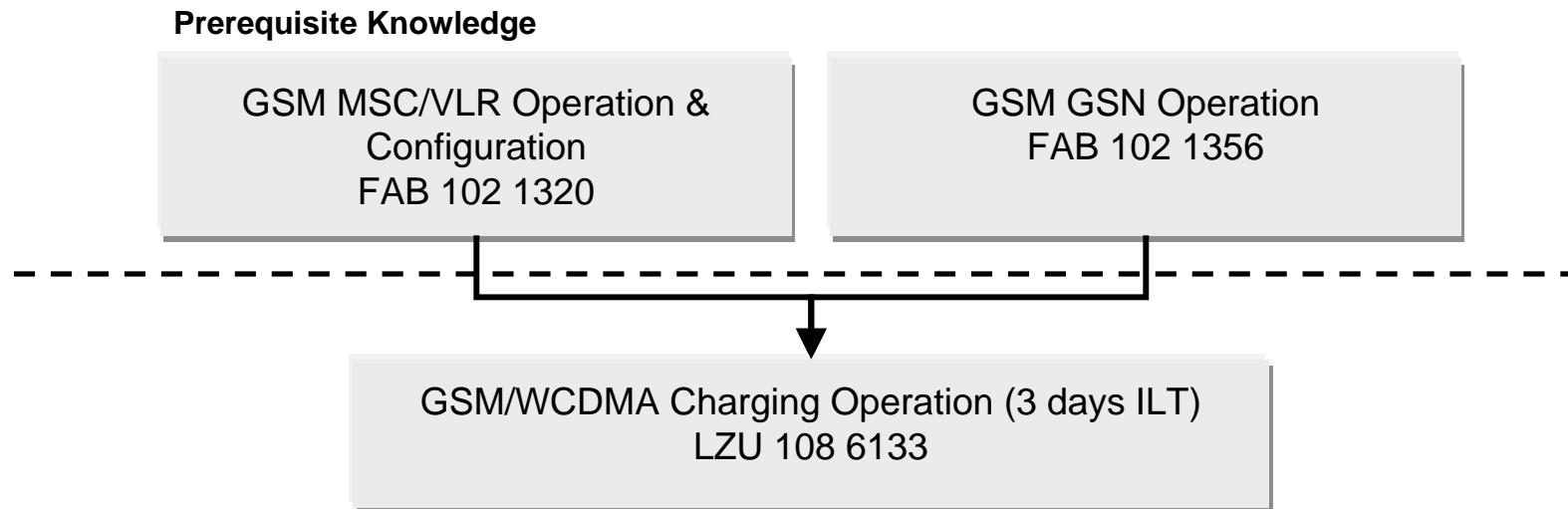

GSM Core Network

– Network Development -

GSM Core Network Statistics Handling (FAB 102 1355)

Prerequisite
Knowledge

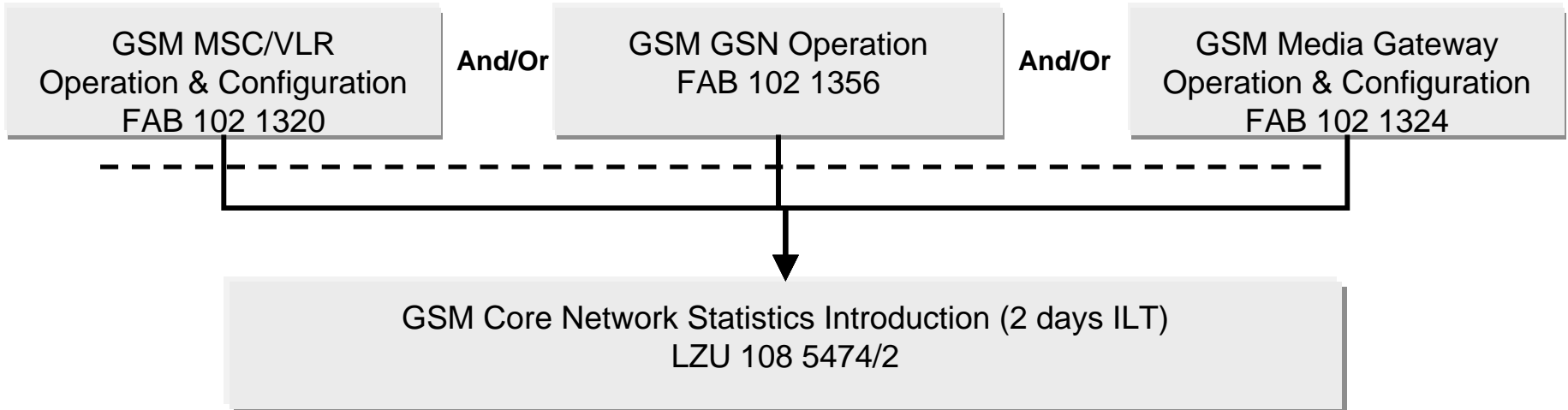

GSM Core Network Planning (FAB 102 1325)

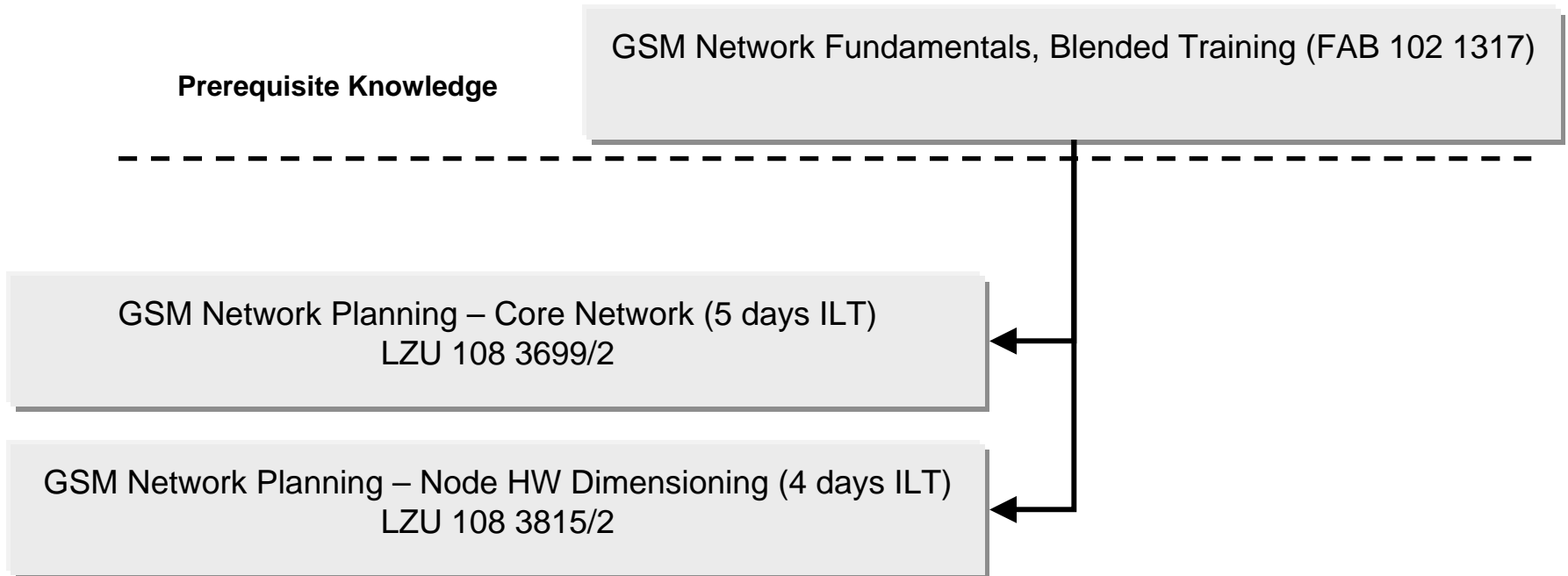

GSM Transport Network

- Network Operation and Configuration-

AXD 301/305 Field Maintenance (FAB 102 1341)

Prerequisite
Knowledge



ATM Fundamentals
FAB 102 1315



AXD 301/305 Hardware Maintenance (1 day ILT)
LZU 108 6130

AXD 301/305 6.0 Network Operation & Configuration (FAB 102 1342)

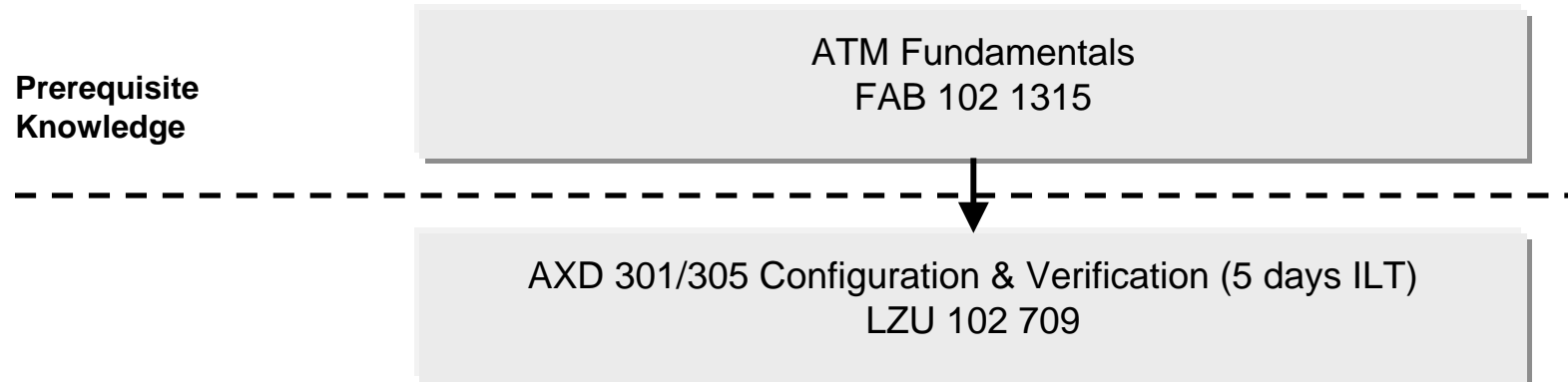

AXI 520/580 Network Configuration (FAB 102 1354)

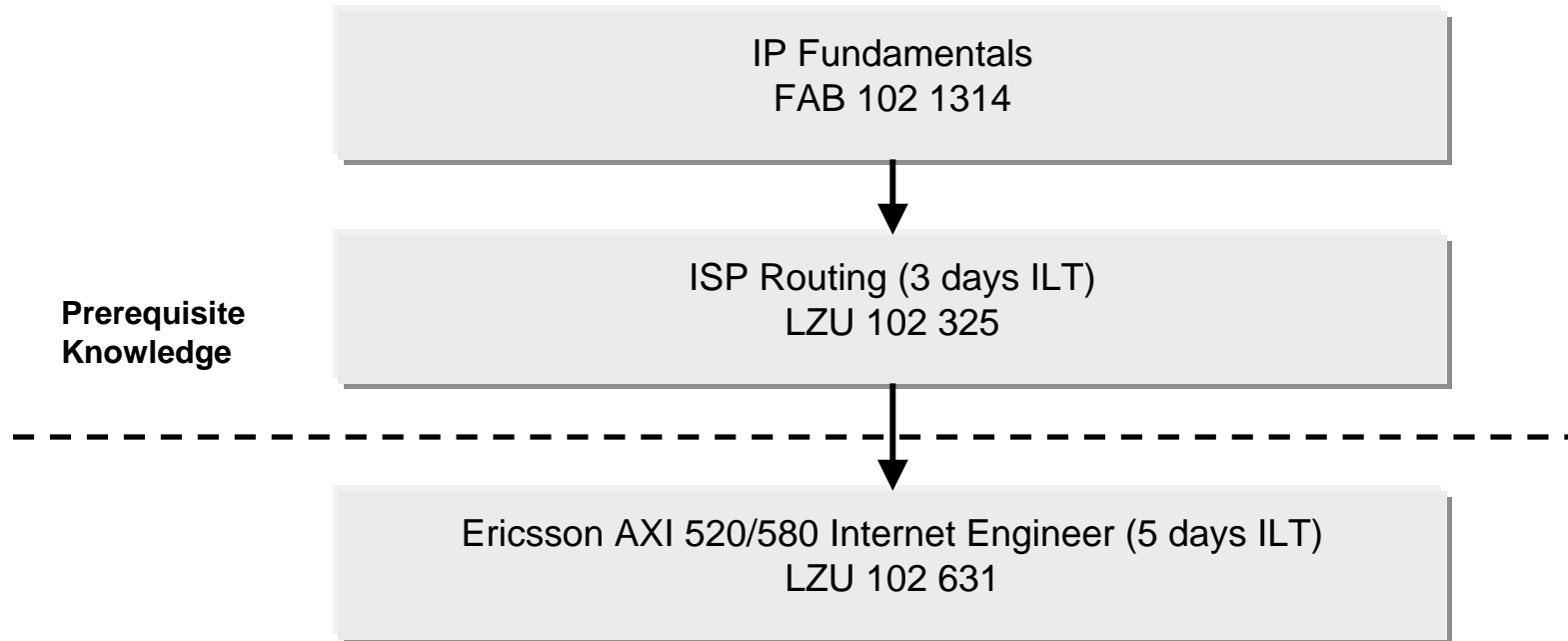

GSM Radio Access Network

- Delta Training -

GSM Radio Access Network Delta Training (FAB 102 1422)

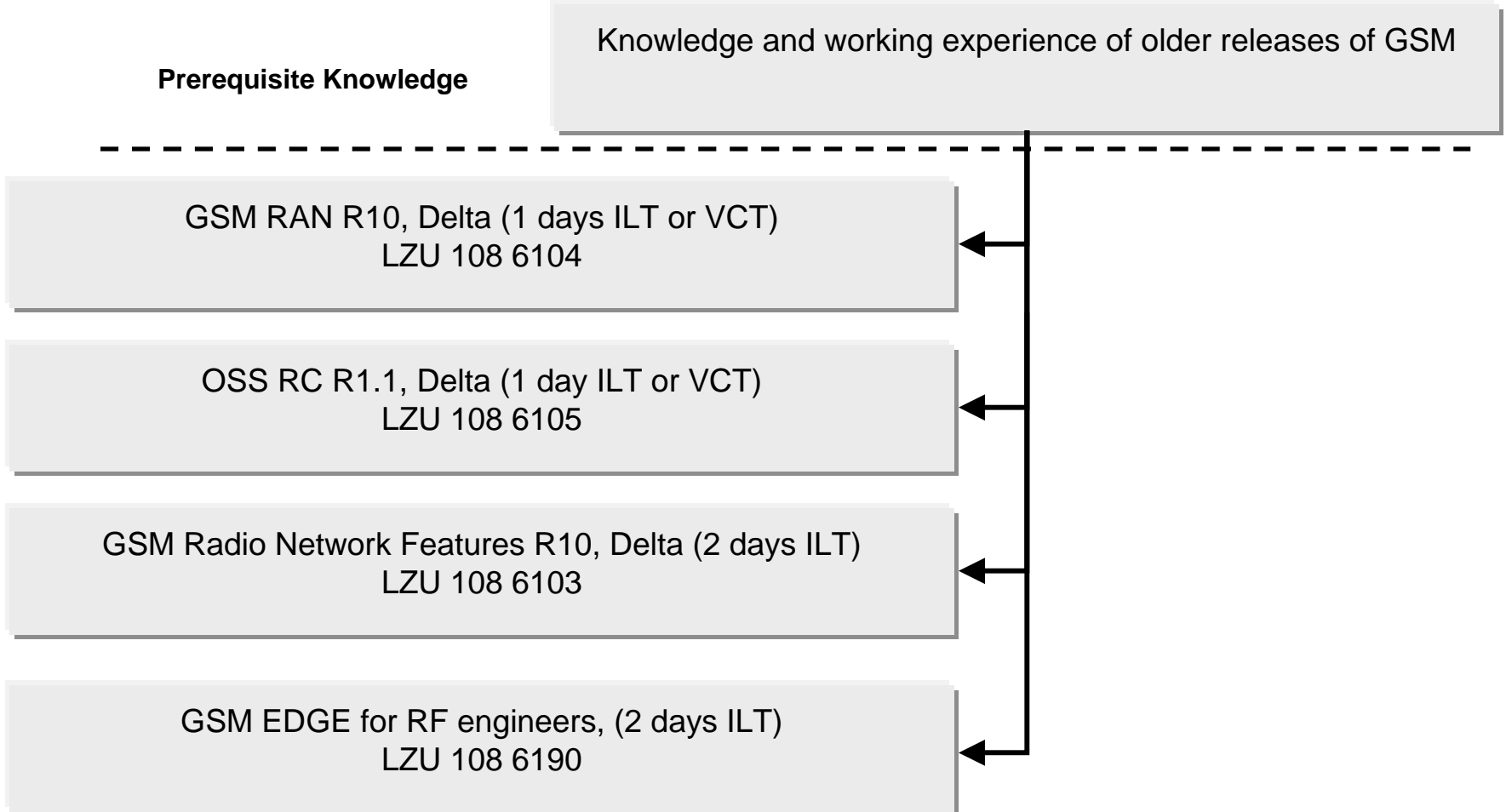

GSM Radio Access Network

- Field Maintenance -

GSM RBS Field Maintenance (FAB 102 1326)

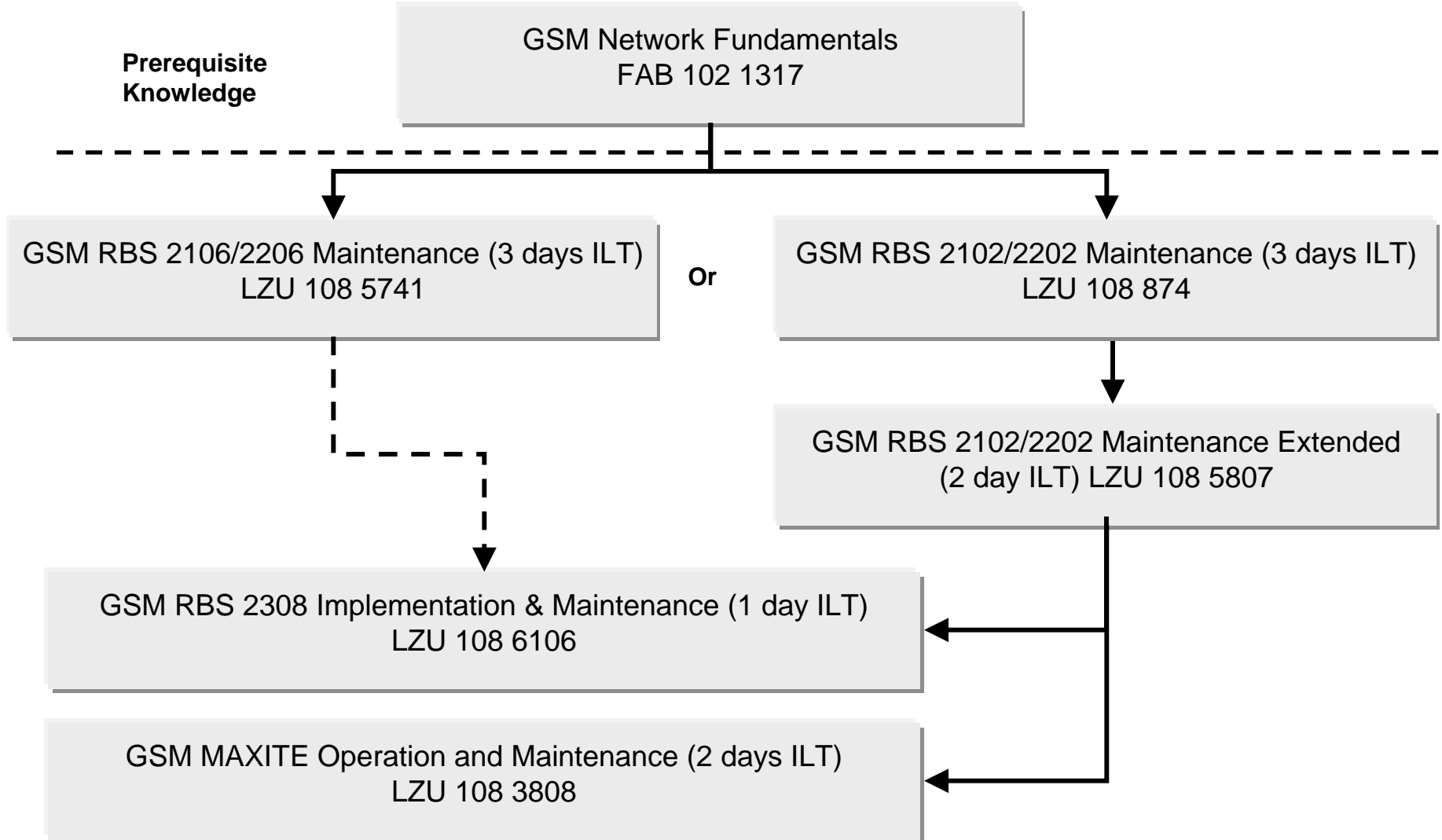

GSM BSC Maintenance (FAB 102 xxxx)

Prerequisite Knowledge

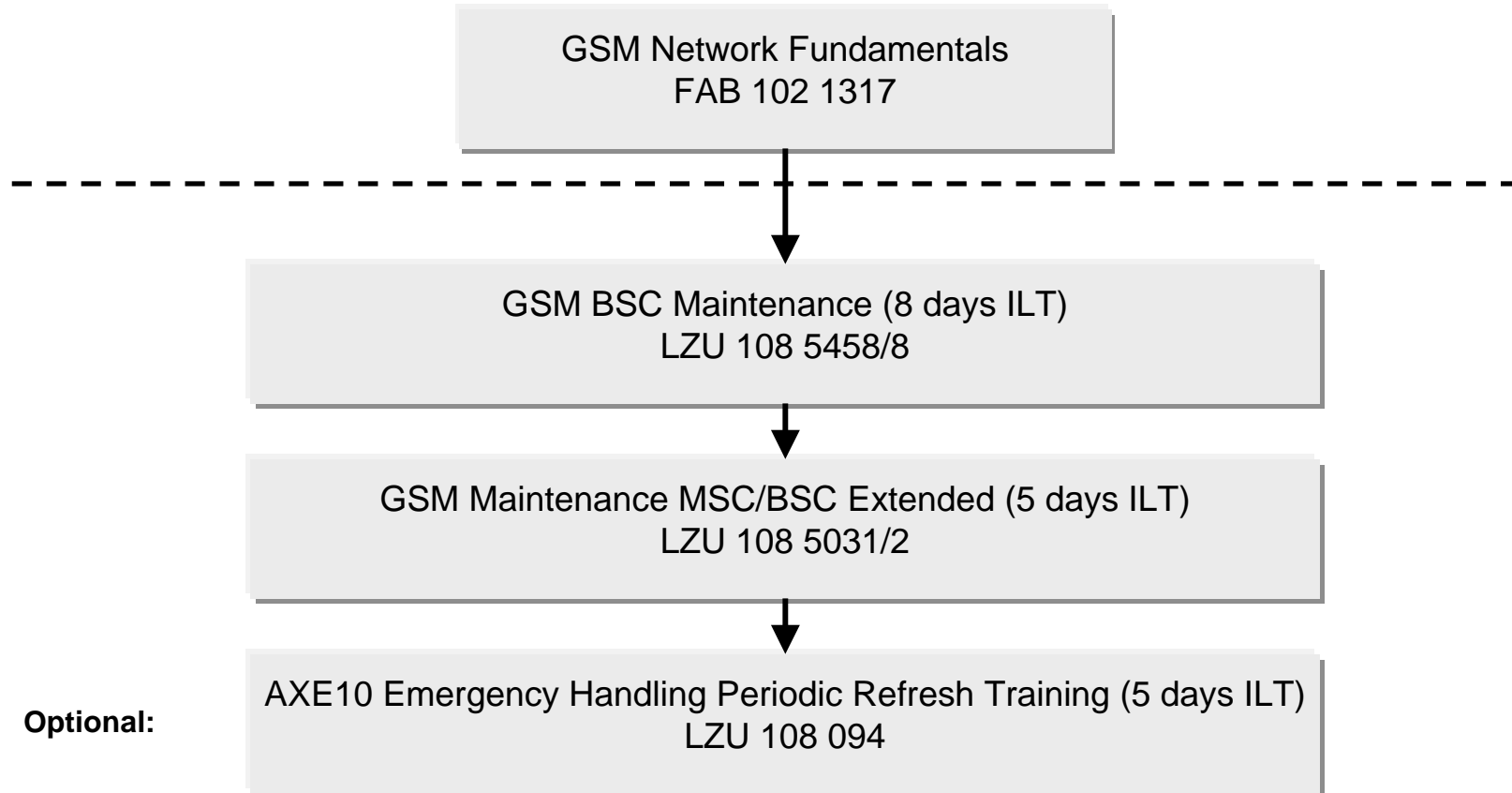

GSM Radio Access Network

– Network Operation and Configuration -

GSM RAN Network Surveillance (FAB 102 1327)

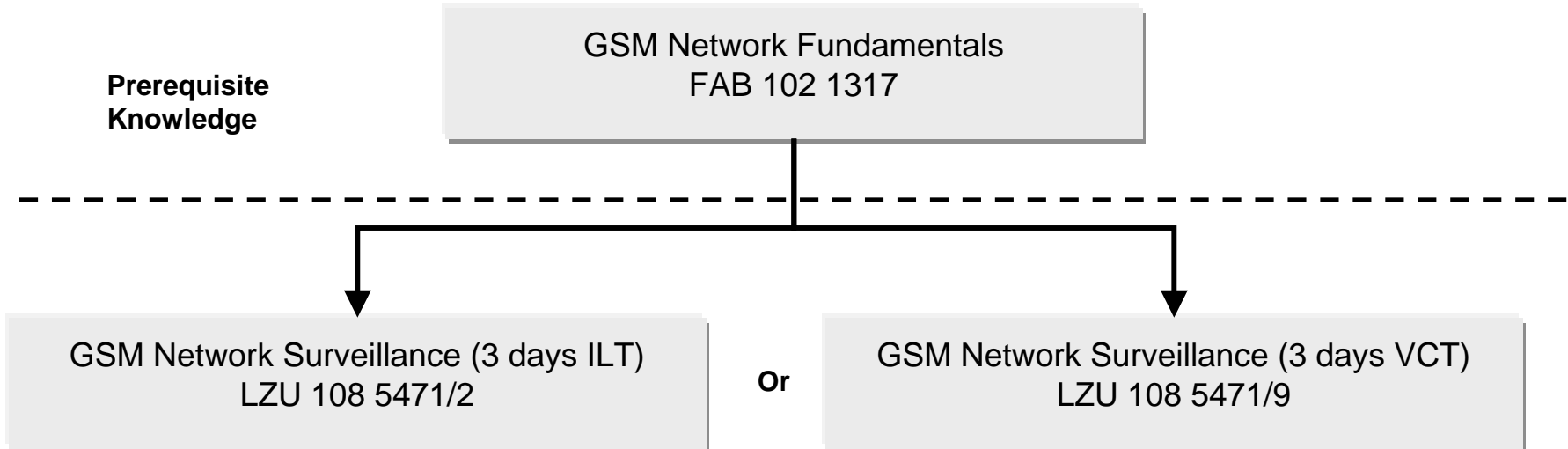

GSM RBS Configuration (FAB 102 1424)

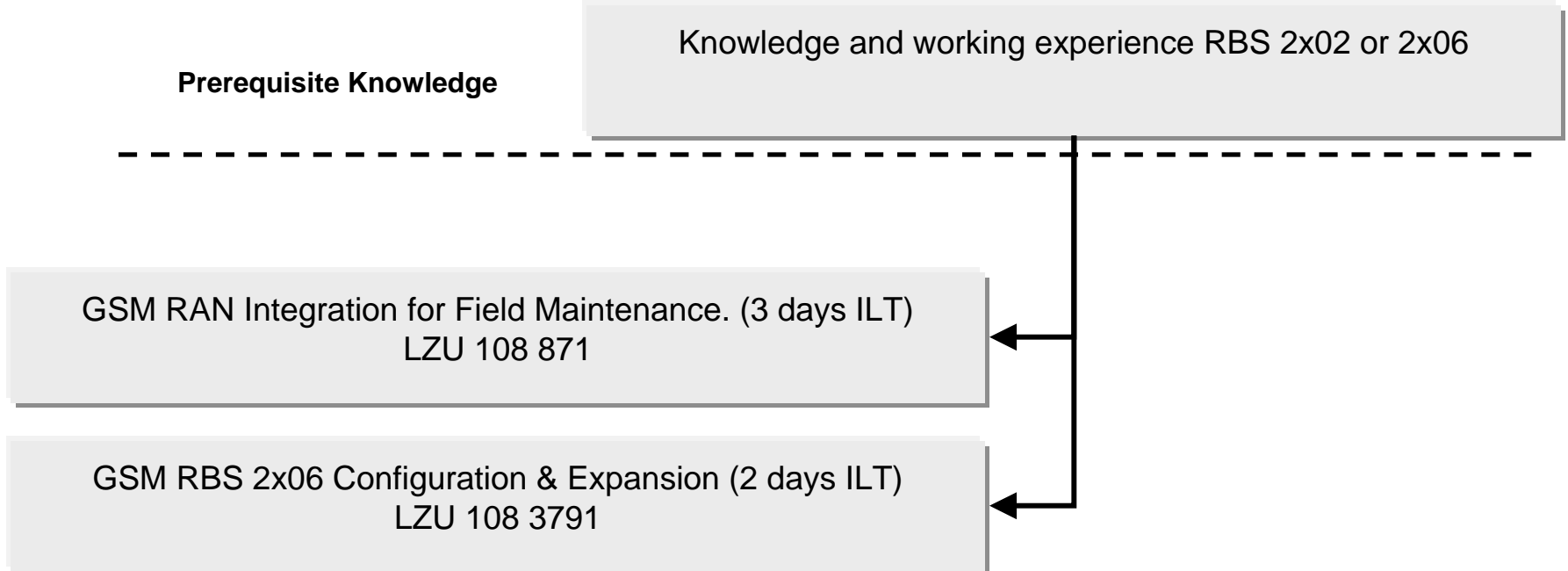

GSM BSC Operation & Configuration (FAB 102 1320)

Prerequisite Knowledge

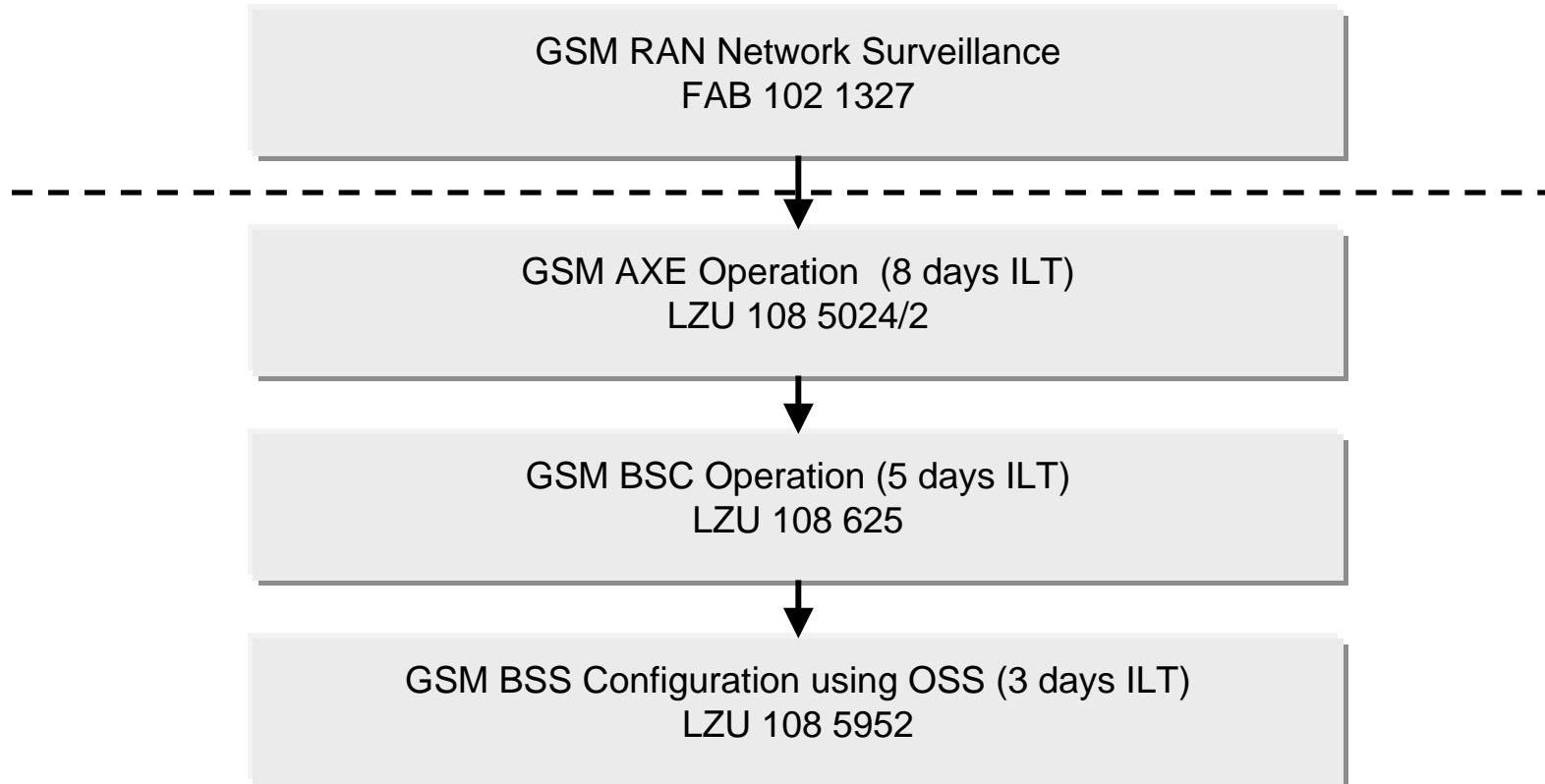

GSM BSC Operation & Configuration, optional courses

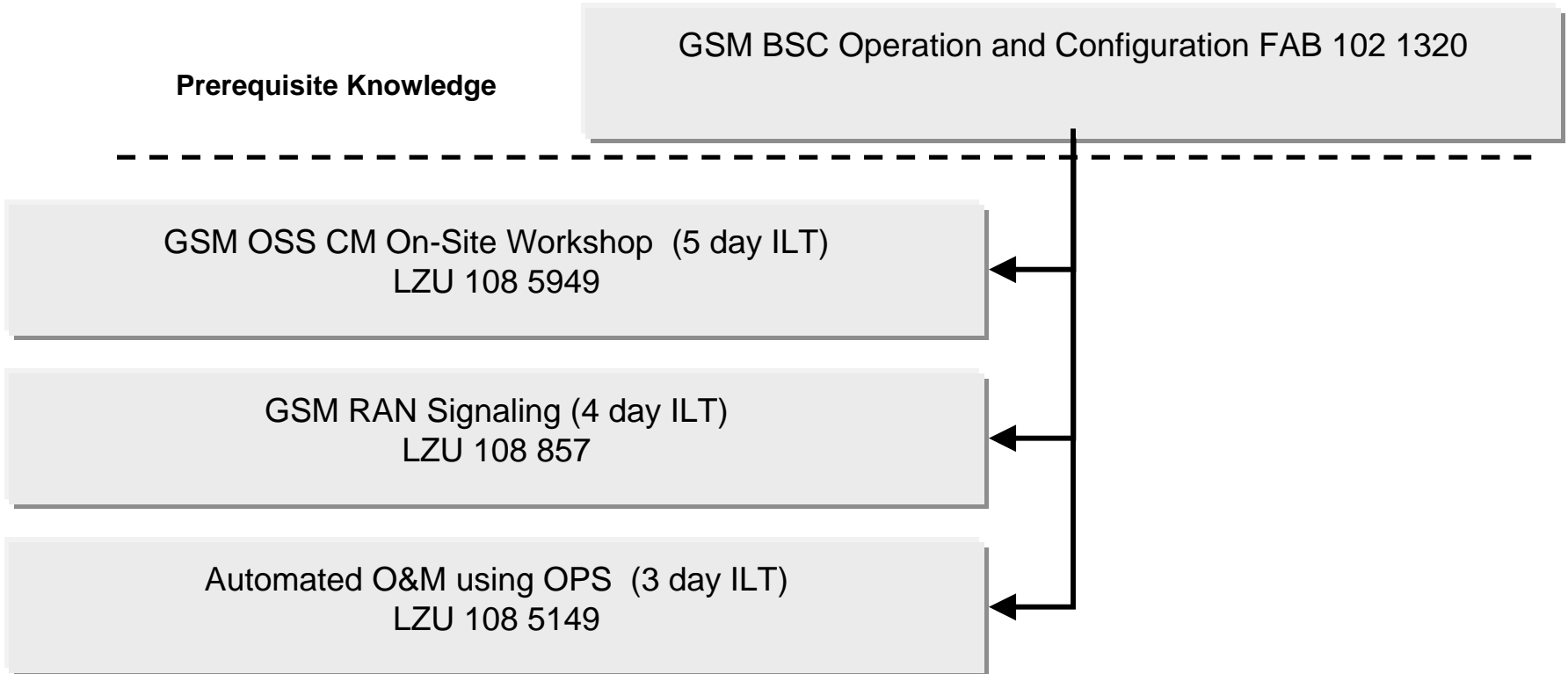

GSM Radio Access Network

– Network Development -

GSM Radio Access Network Design (FAB 102 1425)

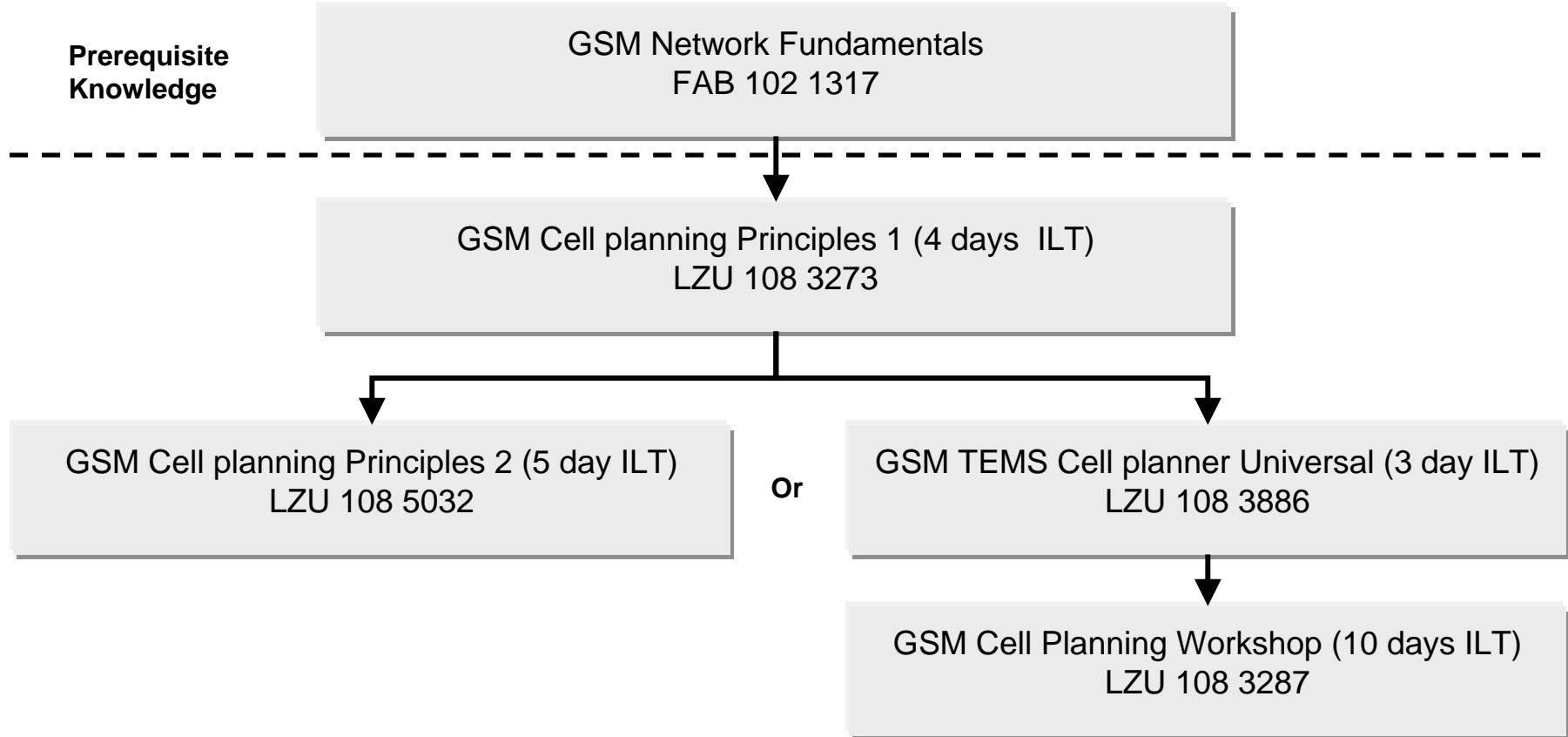

GSM Radio Network Statistics (FAB 102 1426)

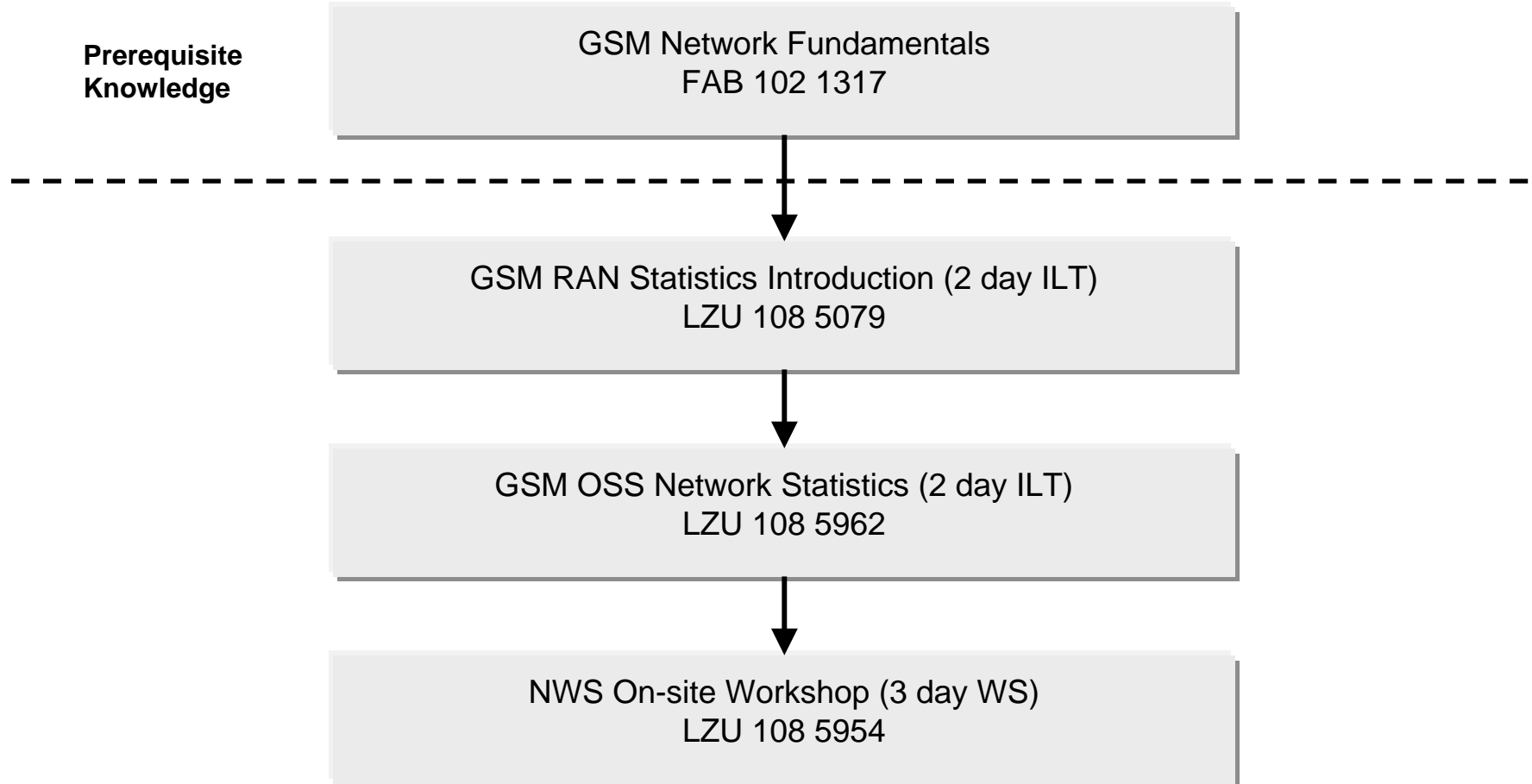

GSM Radio Network Optimization (FAB 102 1427)

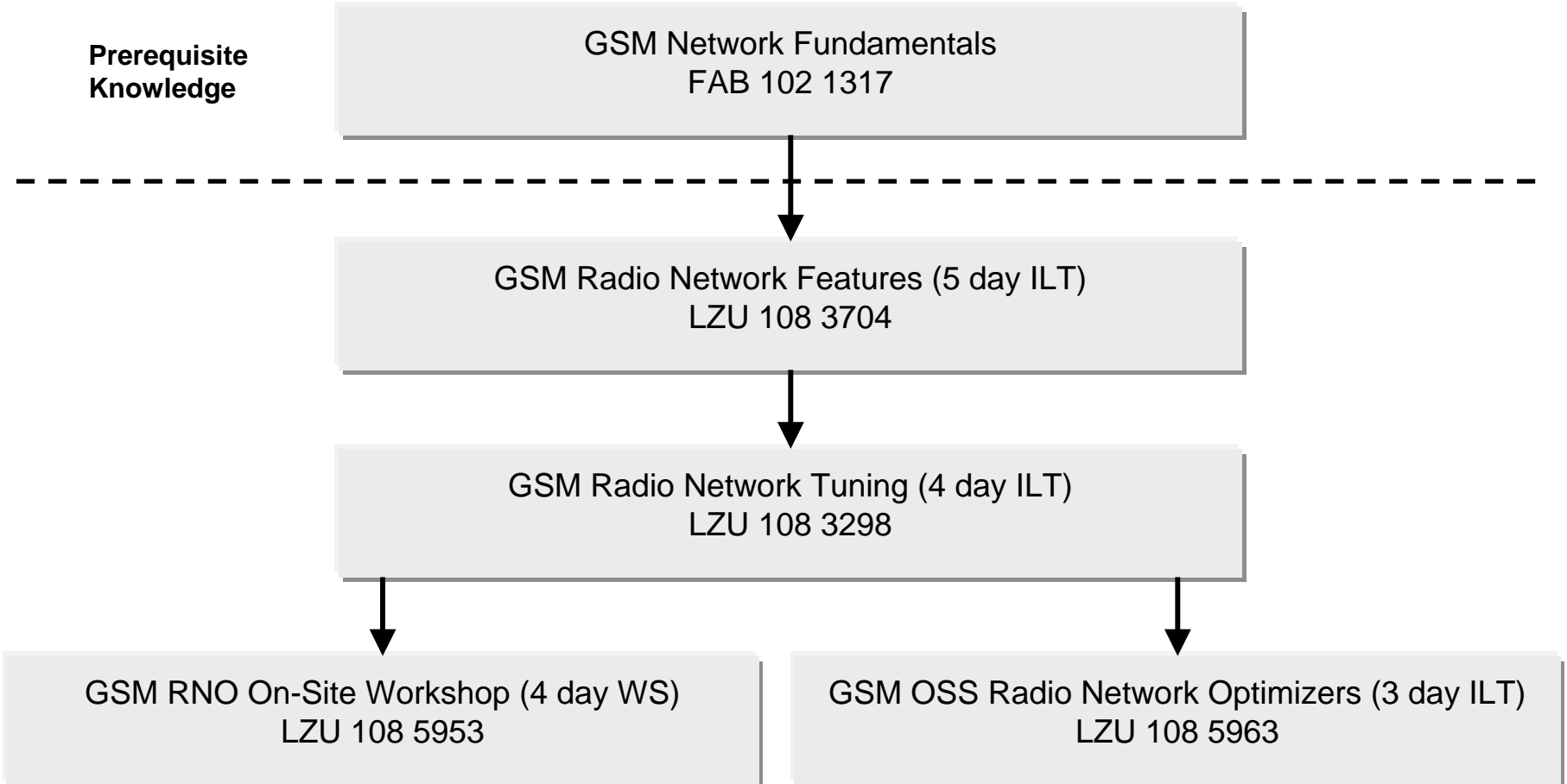

GPRS Network Statistics Handling (FAB 102 1355)

Prerequisite
Knowledge

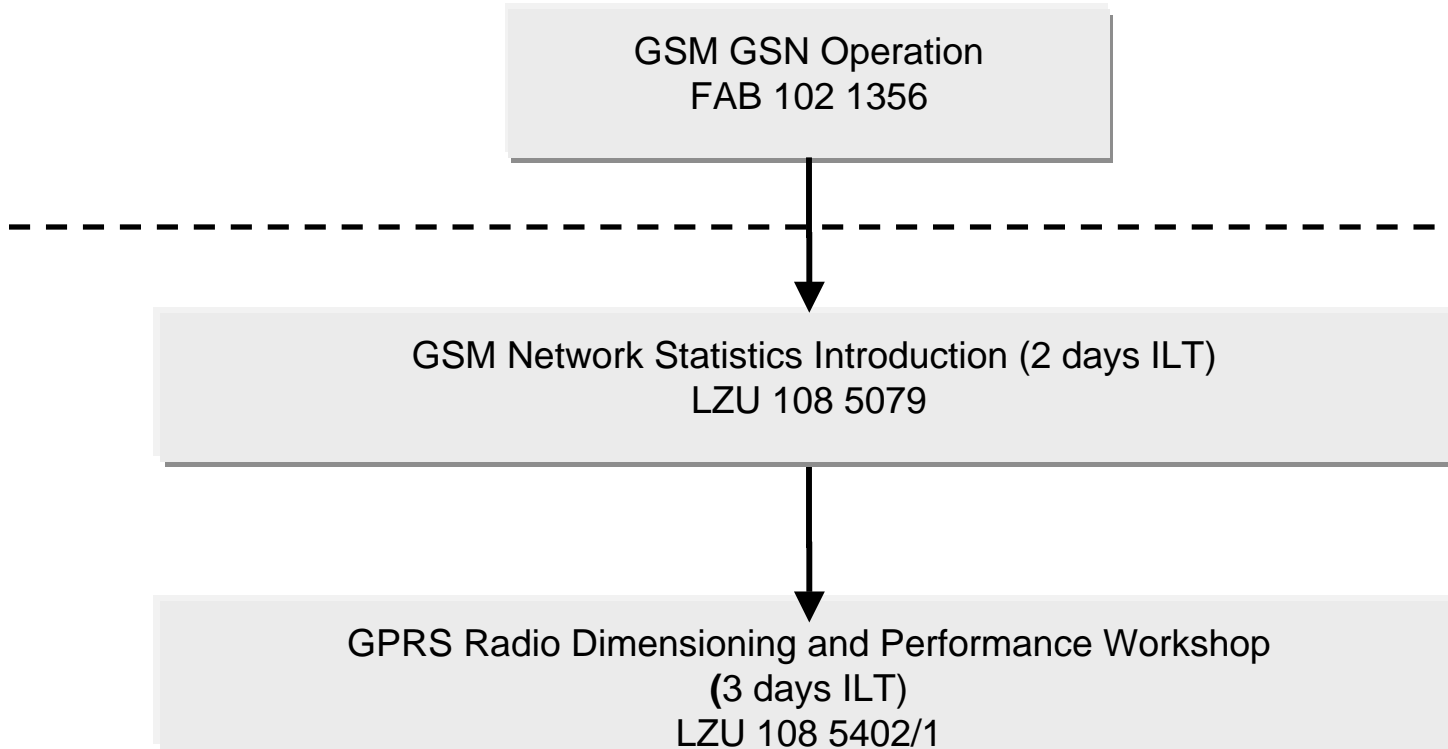

GPRS other courses

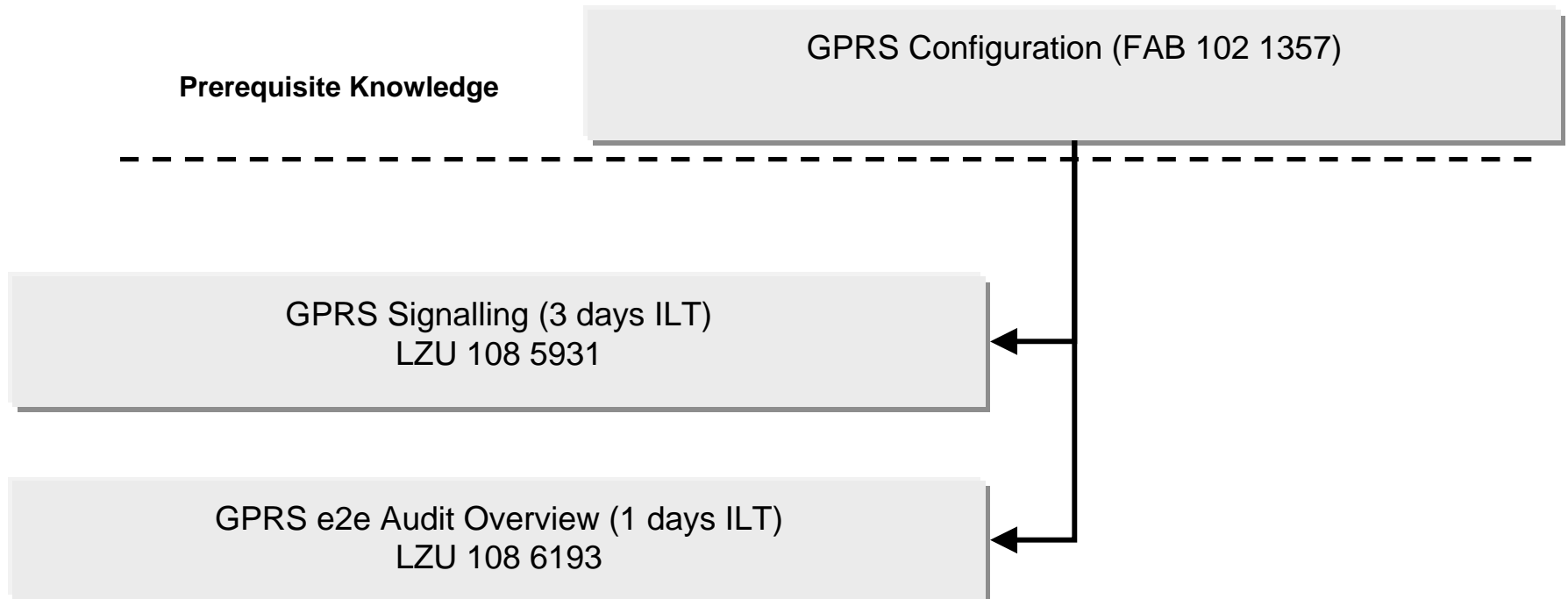

GSM Network Management

- Operation -

OSS RC Introduction (FAB 102 1379)

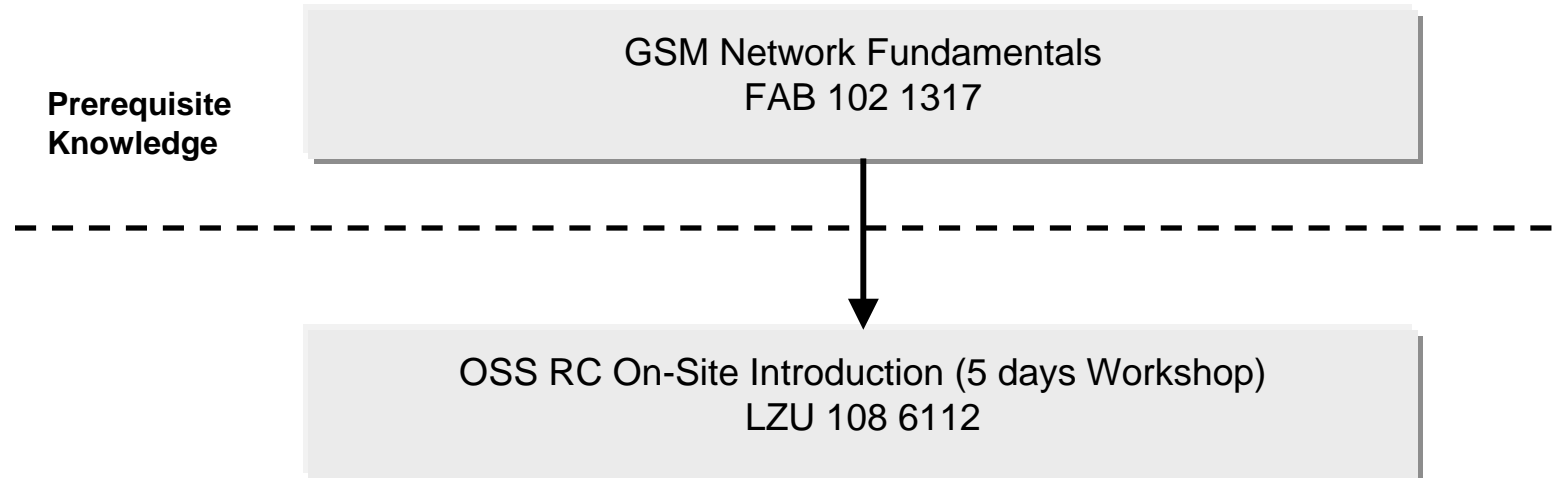

GSM Network Management

- System Administration -

OSS RC System Administration, Standard Maintenance (FAB 102 1380)

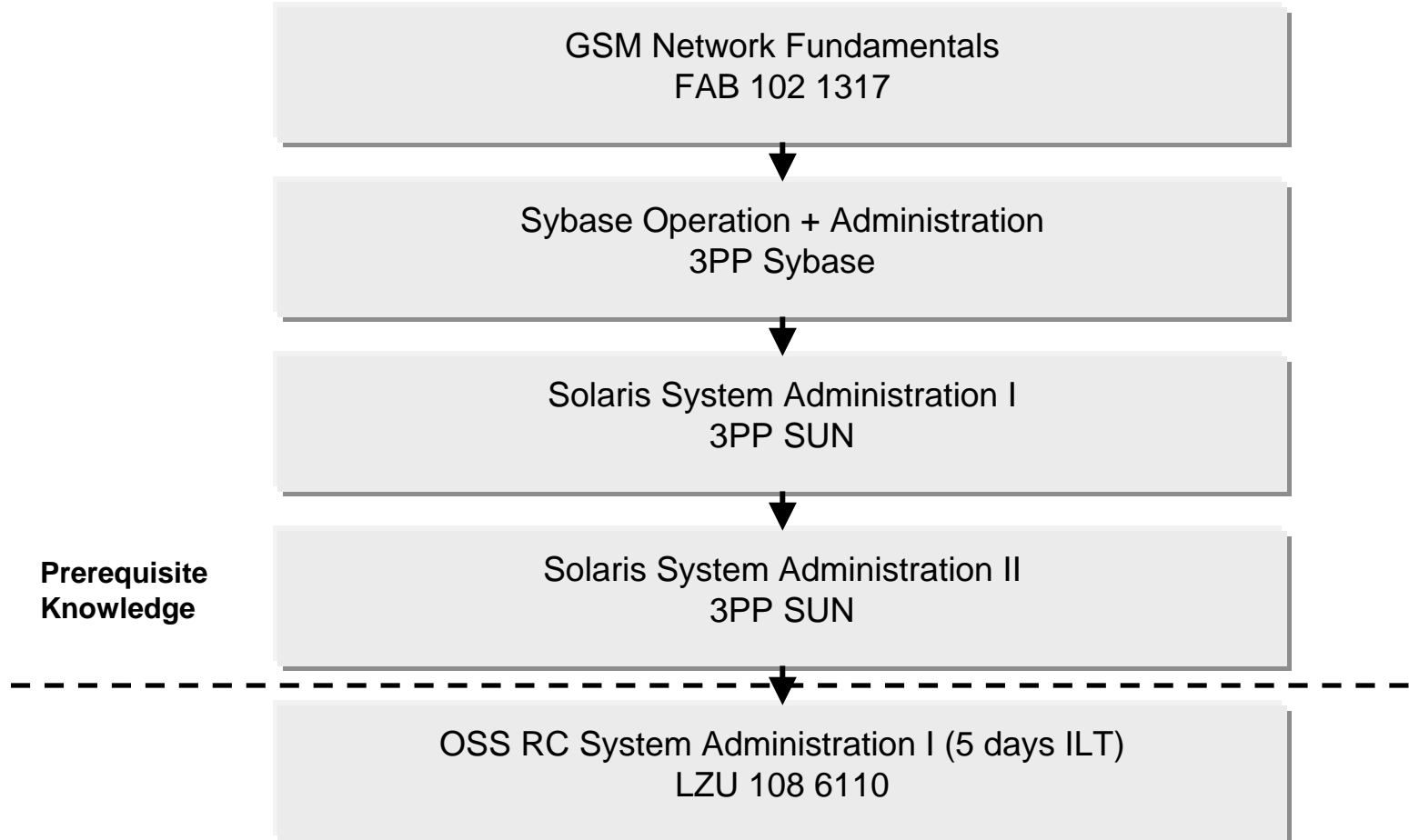

OSS RC System Administration, Corrective Maintenance (FAB 102 1381)

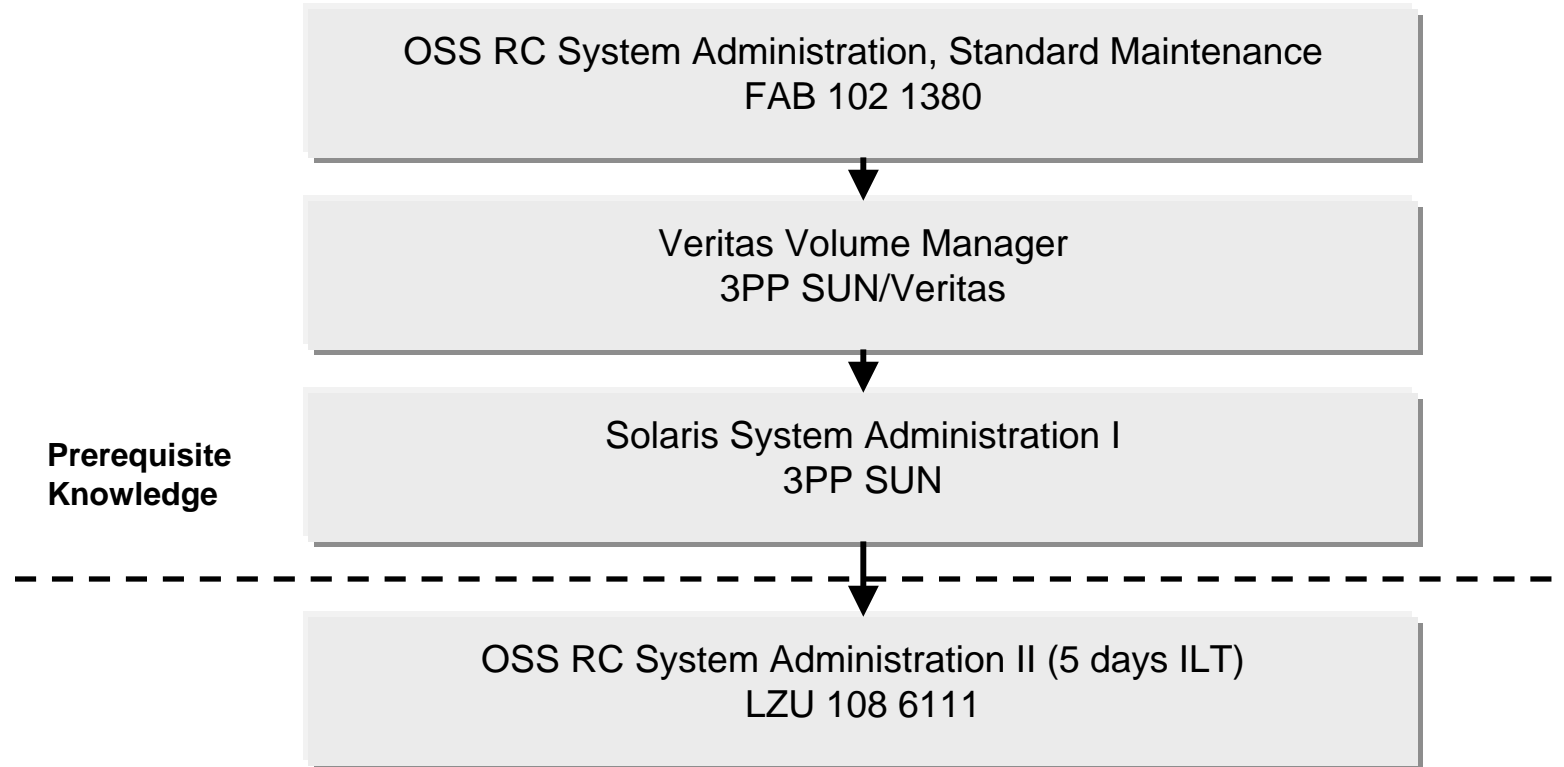

How do we deliver?

- ILT courses, delivered at Ericsson training centres or at customers site.
- e-learning products delivered by either Internet solution or Education Online portal on the extranet towards external customers.



Why Ericsson Education?

Global strength local expertise

- One of the worlds largest competence solutions suppliers

Broad Global Service Product Portfolio

Blended learning solutions

- Instructor Led Training (ILT)
- On-the-job programs
- Web based learning (WBL)
- Streaming Videos (SV)
- Seminars
- Multi-media based learning (MBL)
- Virtual Classroom/ Remote Training
- Online Articles
- On the Job Training
- Workshop



**One Stop Shop -
End to end competence solutions**

Cover all competence areas

- Technical/Professional, Business and Human skills

Summary

Be empowered

Ericsson Education is your competence partner. Linking human performance to business outcomes will give you the power to succeed. Our solutions combine global strength with local expertise - increase your performance anytime, anywhere.

With us, you will be first choice.

