

Ericsson GSM RAN R11 Training Programs

Package Presentation

Name

Title

Ericsson Global Services

xxxxx.xxxxx@ericsson.com



Introduction

- The training package is supporting the Ericsson GSM Radio Access Network (RAN) R11 system
- The training package offers clearly defined yet flexible training paths to target specific technical and business staff within your organisation
- The training package uses blended learning – from traditional classroom teaching to learning off the web

Why invest in the Ericsson GSM RAN R11 Training Package?

- **Faster time to revenue**

“You can secure an rapid competence build-up, enabling an early commercial GSM launch.”

- **Cost efficiency**

“With competent and skilled staff, you will have a well-performed network, improving productivity and profitability.”

- **Increased performance/less churn**

“With competent and skilled staff, you will ensure high quality of service, leading to higher end-user satisfaction and competitiveness.”

- **Minimal risk**

“Your competent and skillful staff will be able to help you in maintaining a cost effective organization.”

- **Organizational effectiveness**

“Your staff will become more motivated through competence development and learning culture, which ensure you an effective organization for long-term success.”

GSM Radio Access Network

- Delta Training -

AXE 810 Delta Training (FAB 102 1310)

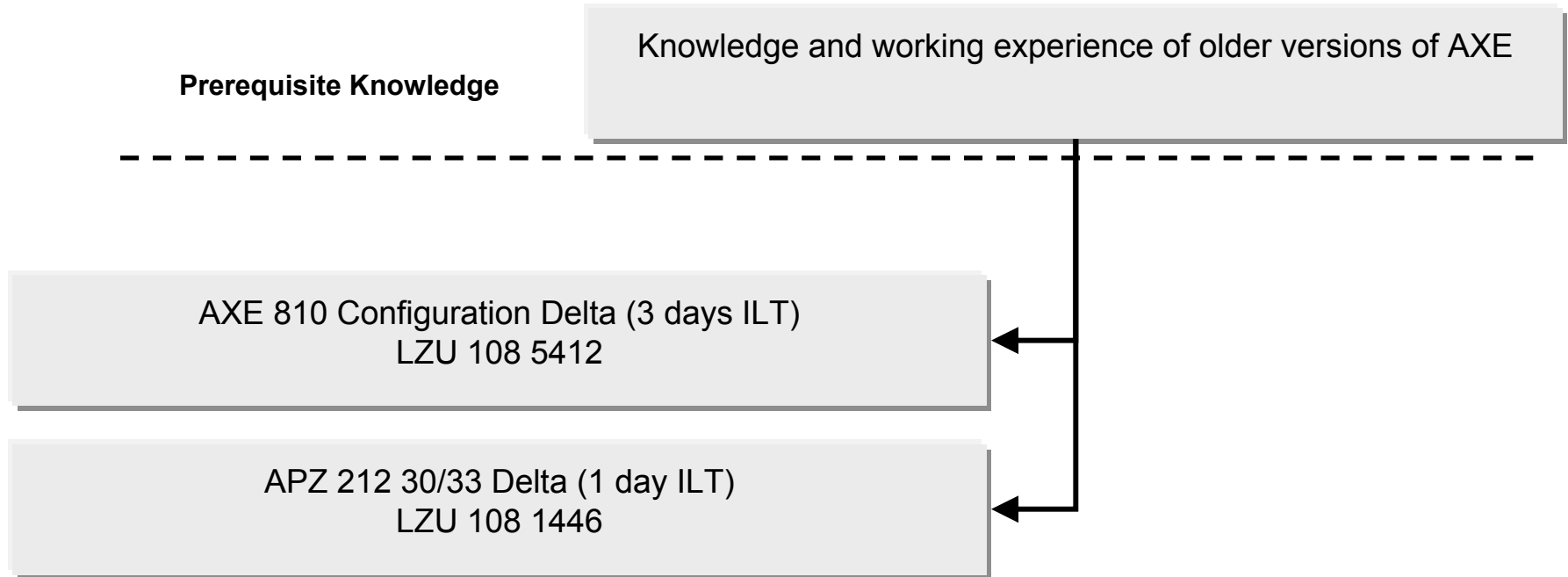

GSM Radio Access Network Delta Training (FAB 102 1422)

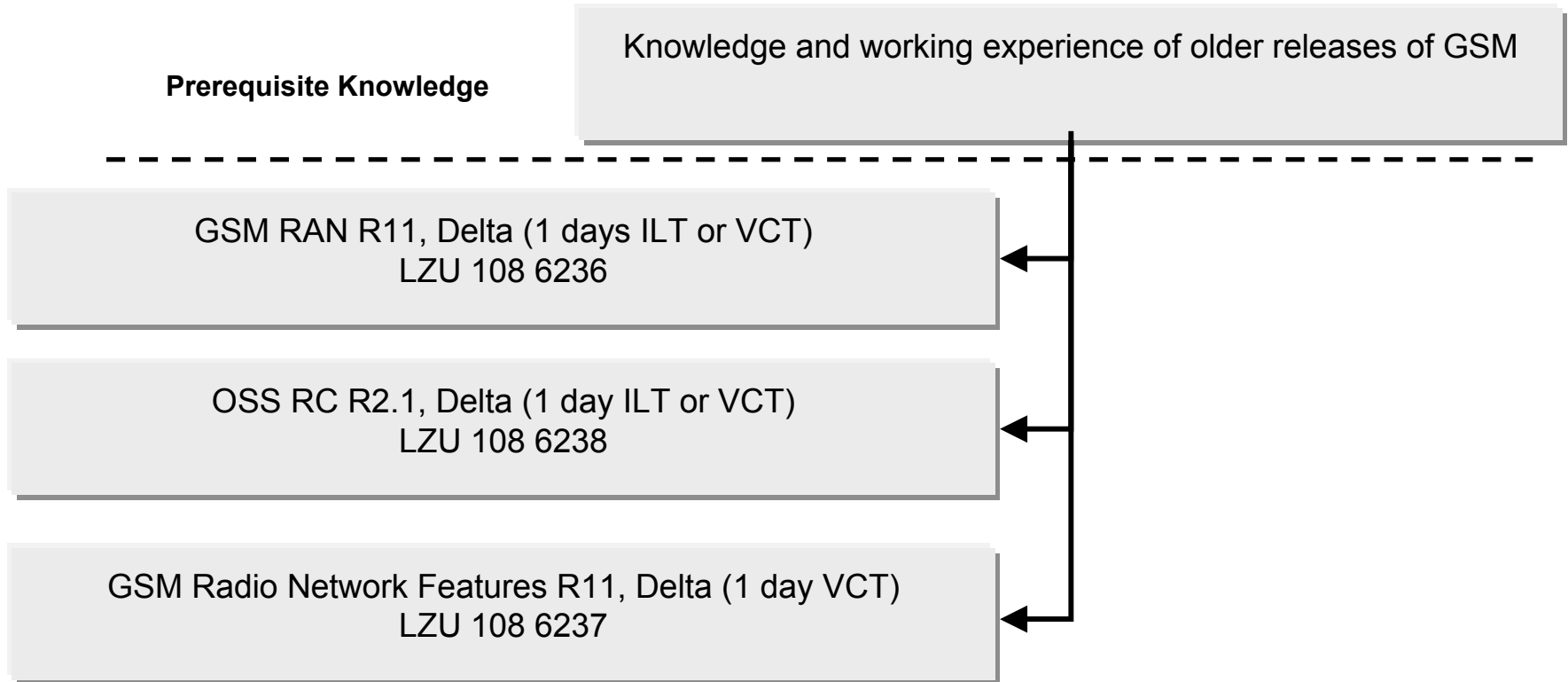

GSM Network

- Fundamentals -

GSM Network Fundamentals, Blended Training (FAB 102 1465)

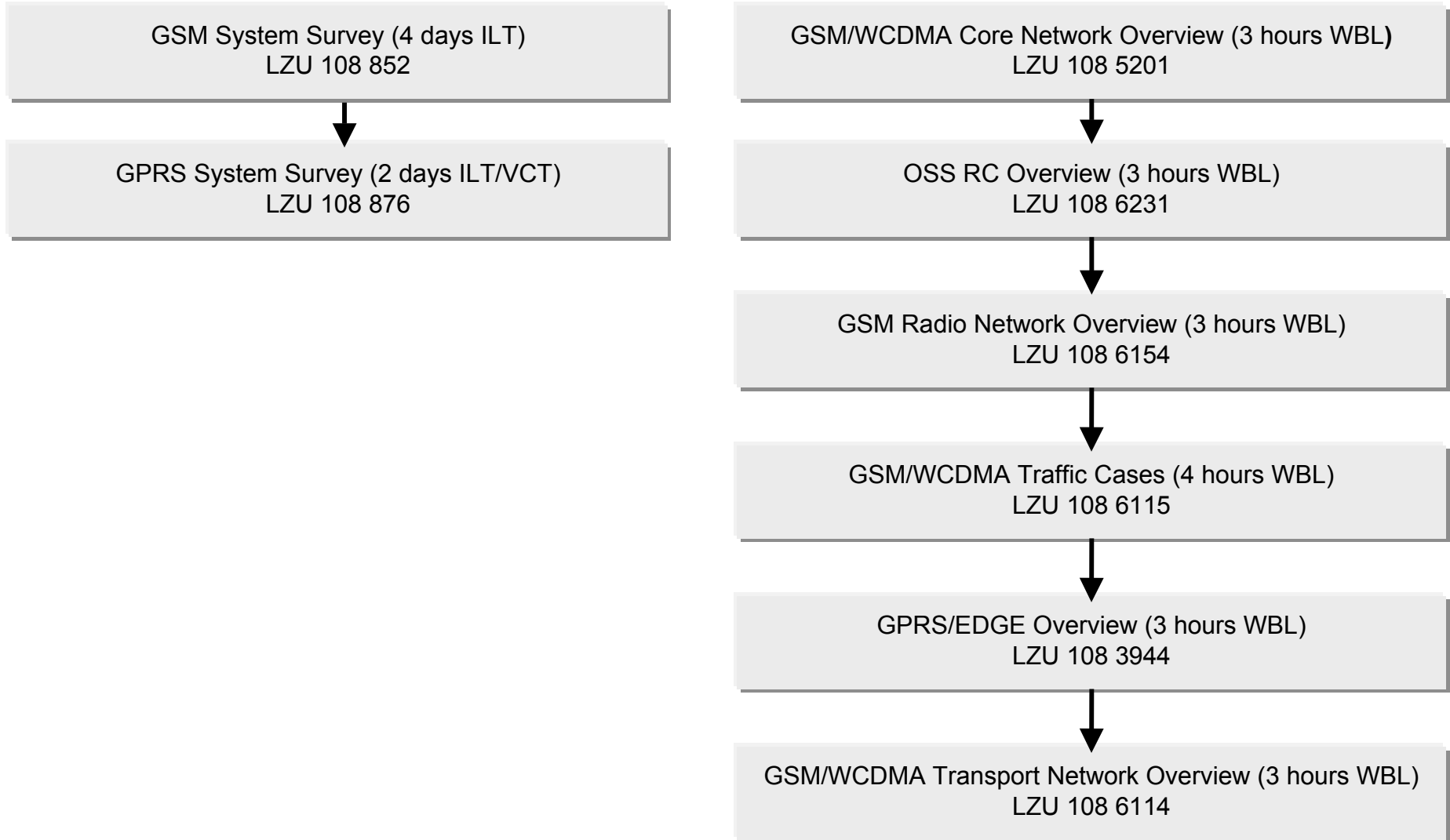

GSM Radio Access Network

- Field Maintenance -

GSM RBS Field Maintenance (FAB 102 1326)

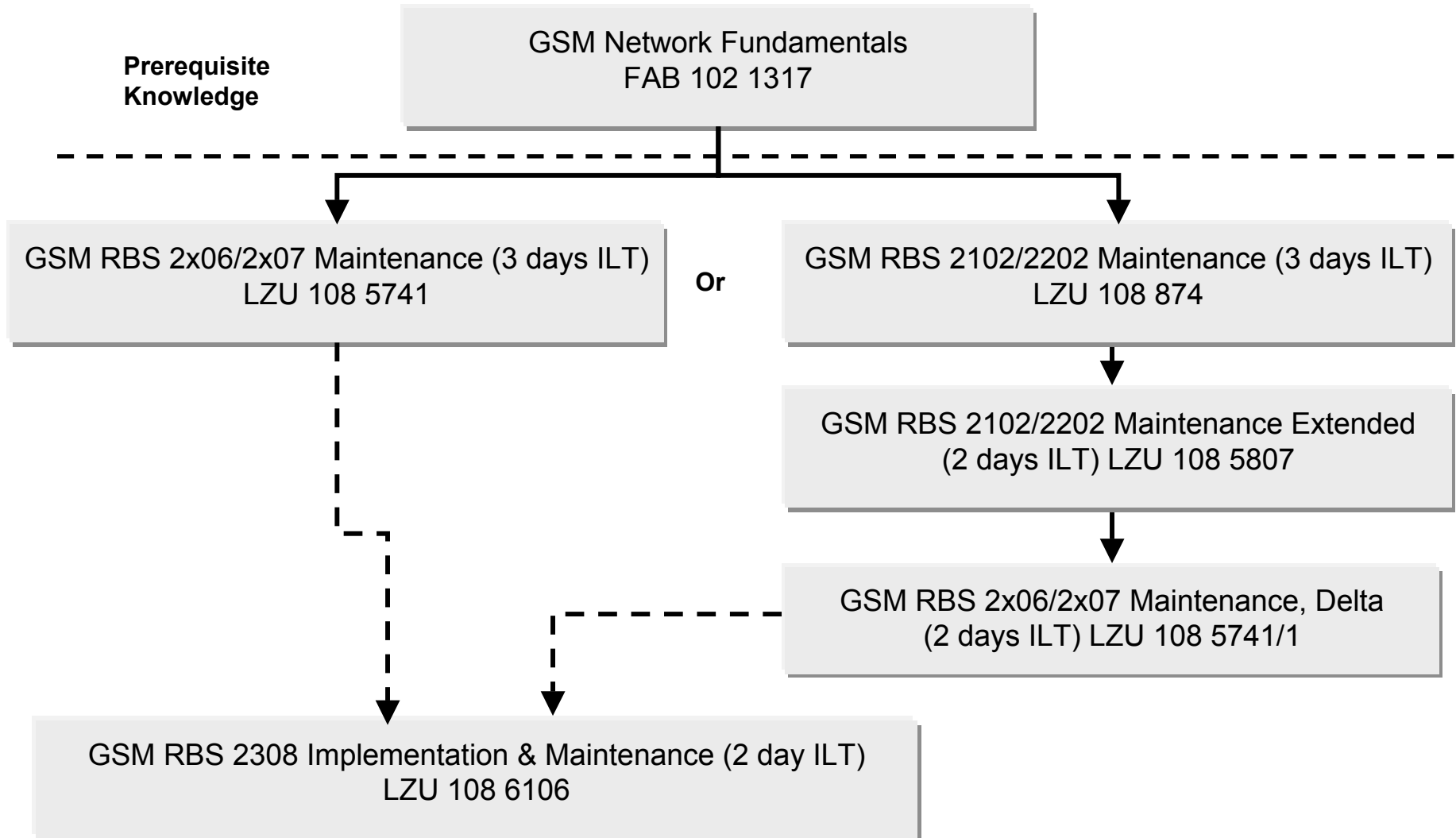

GSM BSC Maintenance (FAB 102 1423)

Prerequisite Knowledge

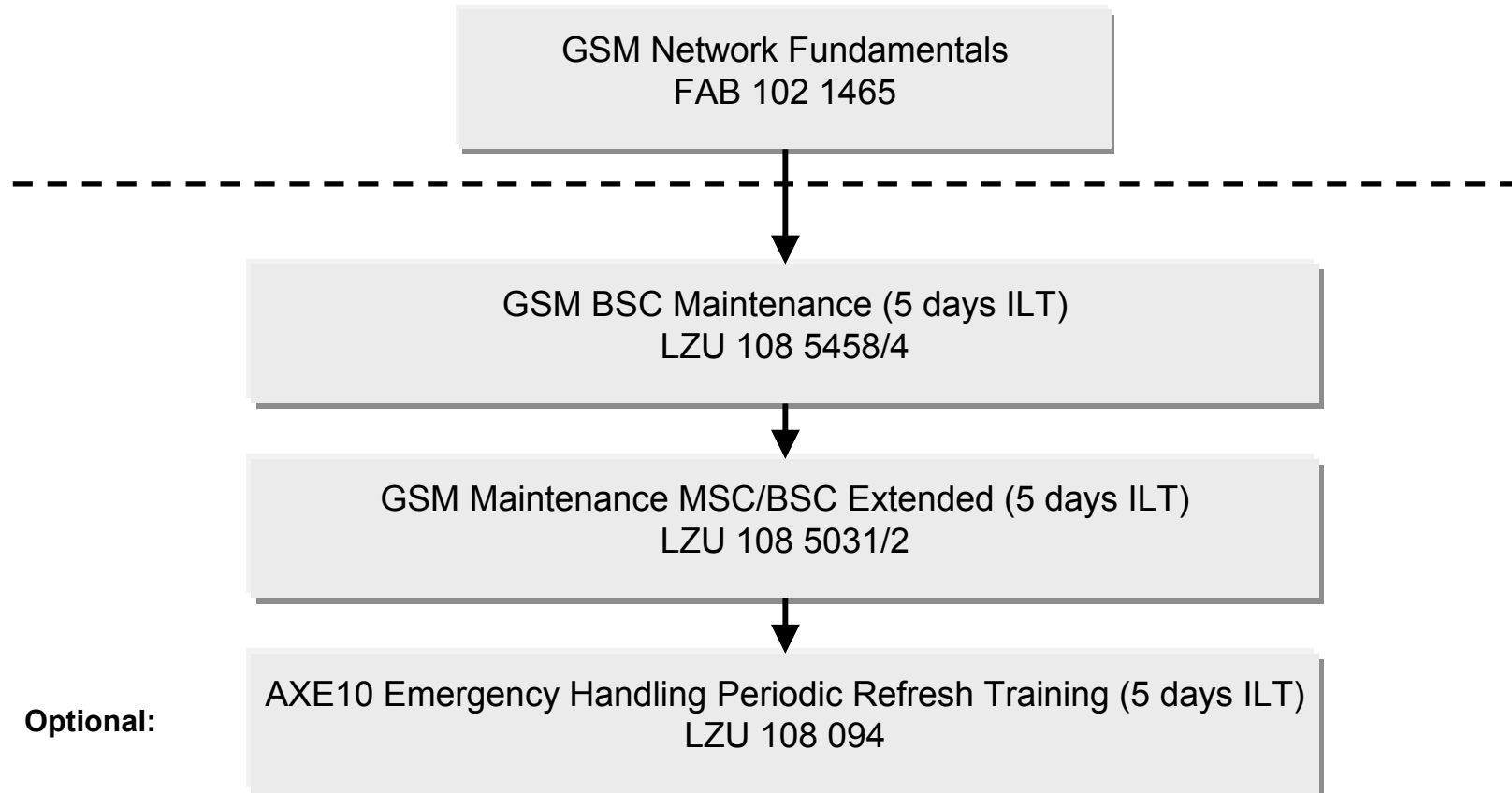

GSM Radio Access Network

– Network Operation and Configuration -

GSM RAN Network Surveillance (FAB 102 1327)

Prerequisite Knowledge

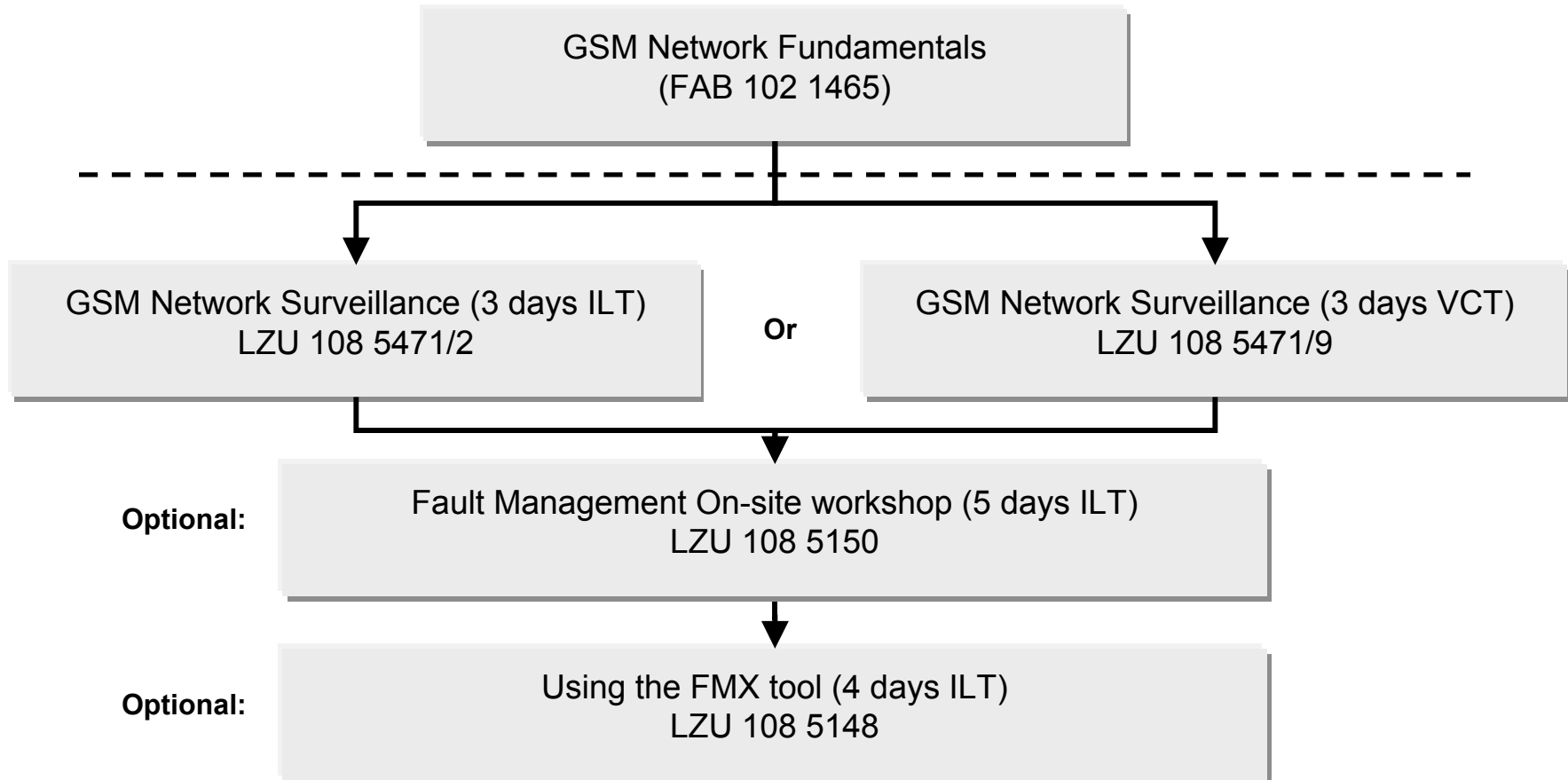

GSM RBS Configuration (FAB 102 1424)

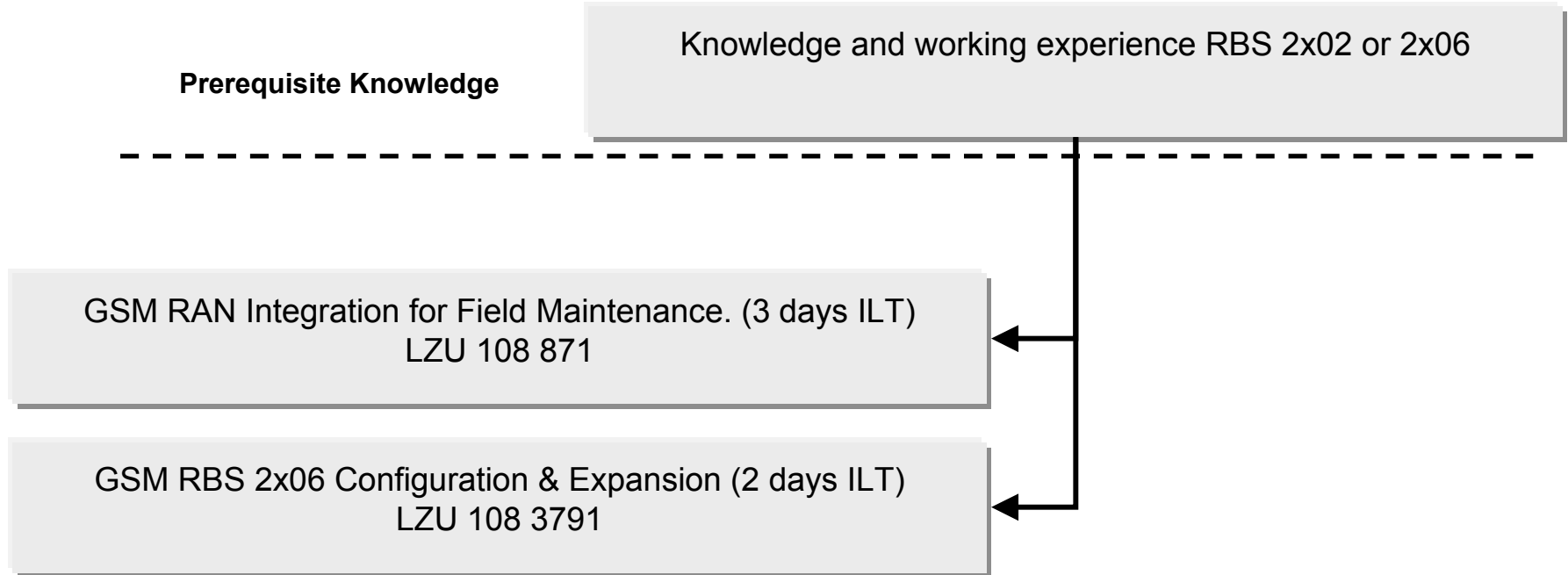

APG 40 Operation and Administration (FAB 102 1345)

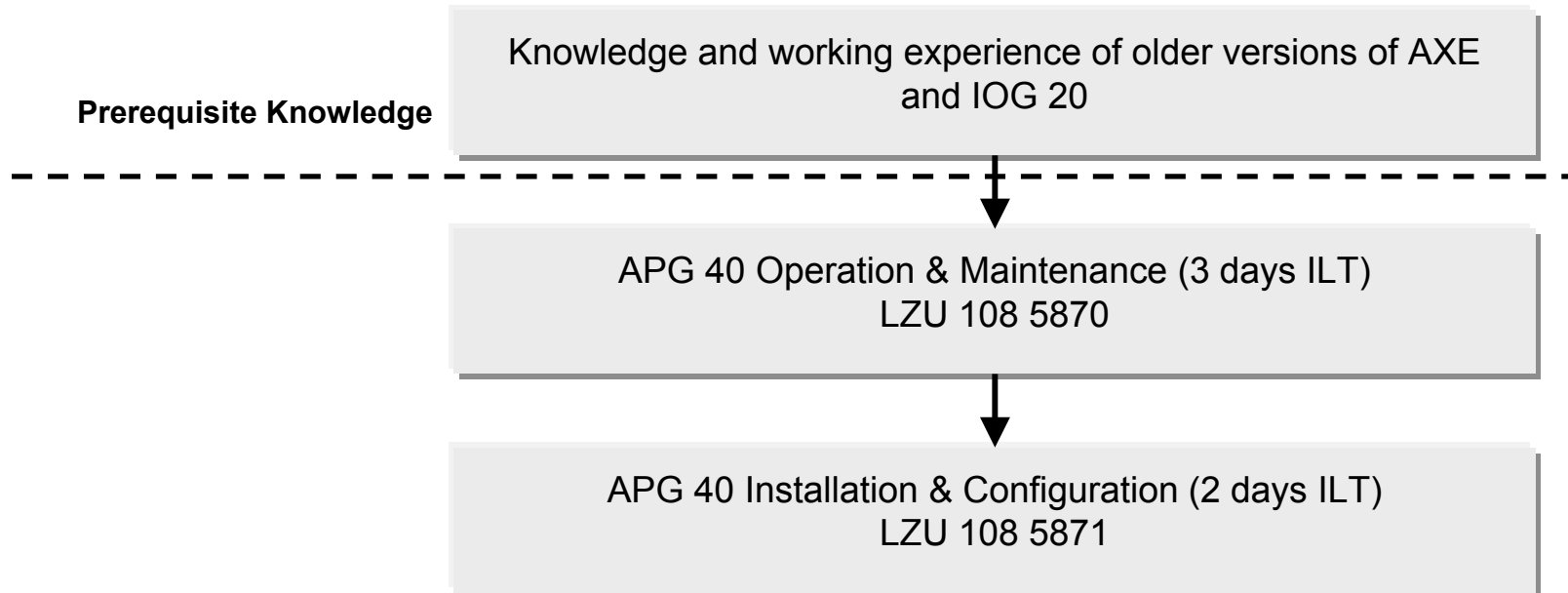

GSM BSC Operation & Configuration (FAB 102 1320)

Prerequisite Knowledge

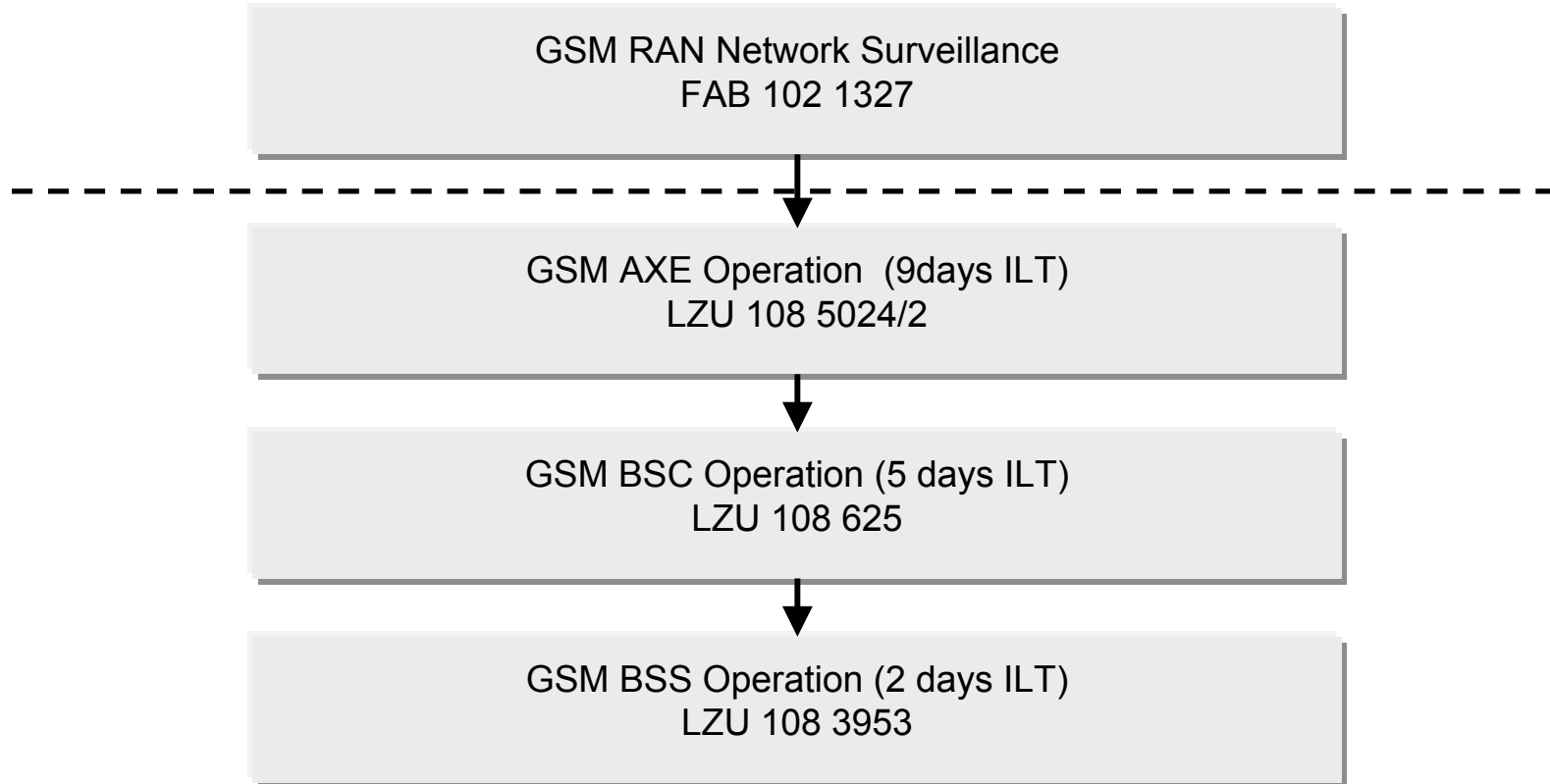

GSM BSC Operation & Configuration, optional courses (FAB 102 1480)

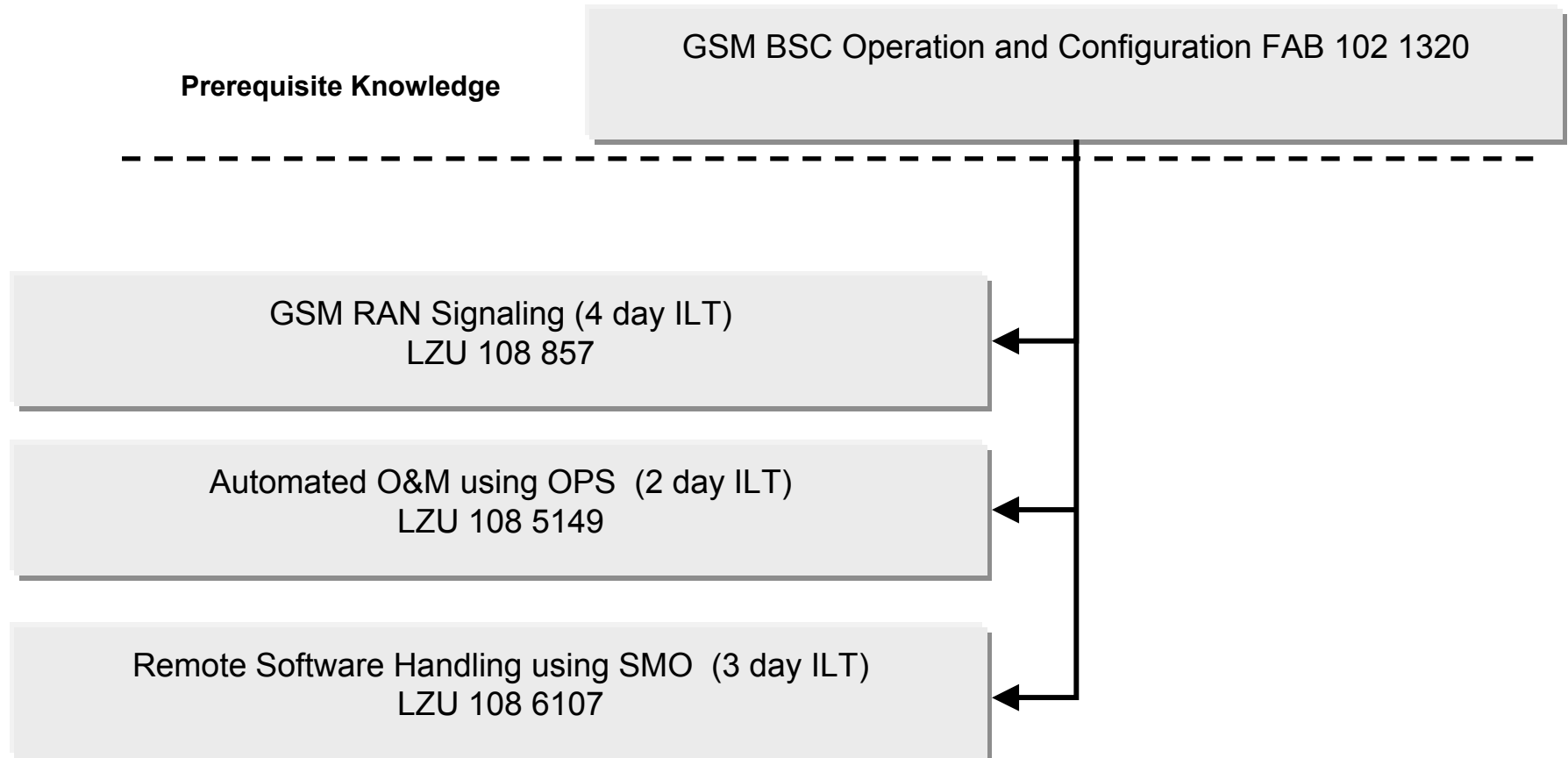

GSM Radio Access Network

– Network Development -

GSM Radio Access Network Design (FAB 102 1425)

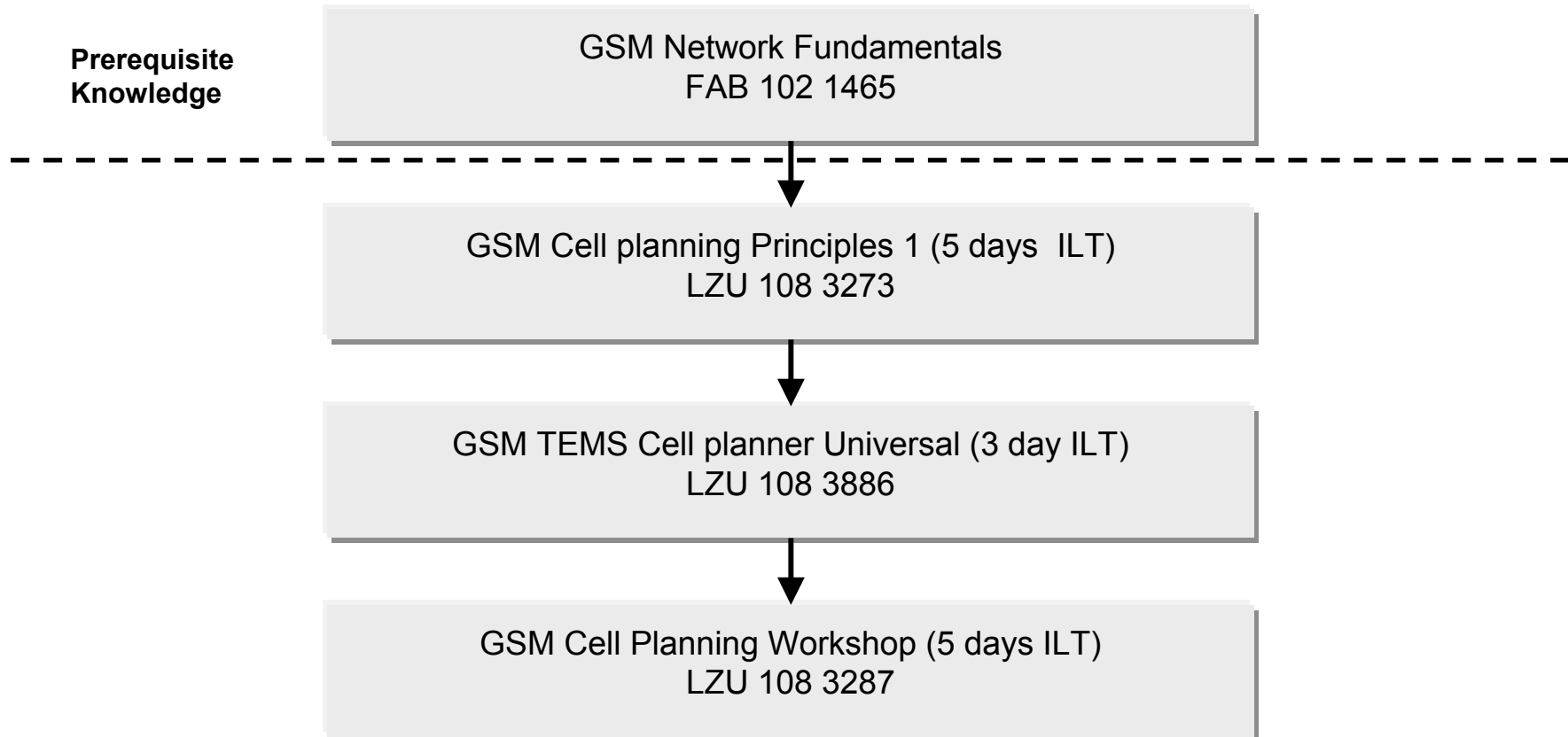

GSM Radio Network Statistics (FAB 102 1426)

**Prerequisite
Knowledge**

GSM Network Fundamentals
FAB 102 1465

GSM RAN Statistics Introduction (2 day ILT)
LZU 108 5079

GSM OSS Network Statistics (2 day ILT)
LZU 108 5962

NWS On-site Workshop (2 day WS)
LZU 108 5954

GSM Radio Network Optimization (FAB 102 1427)

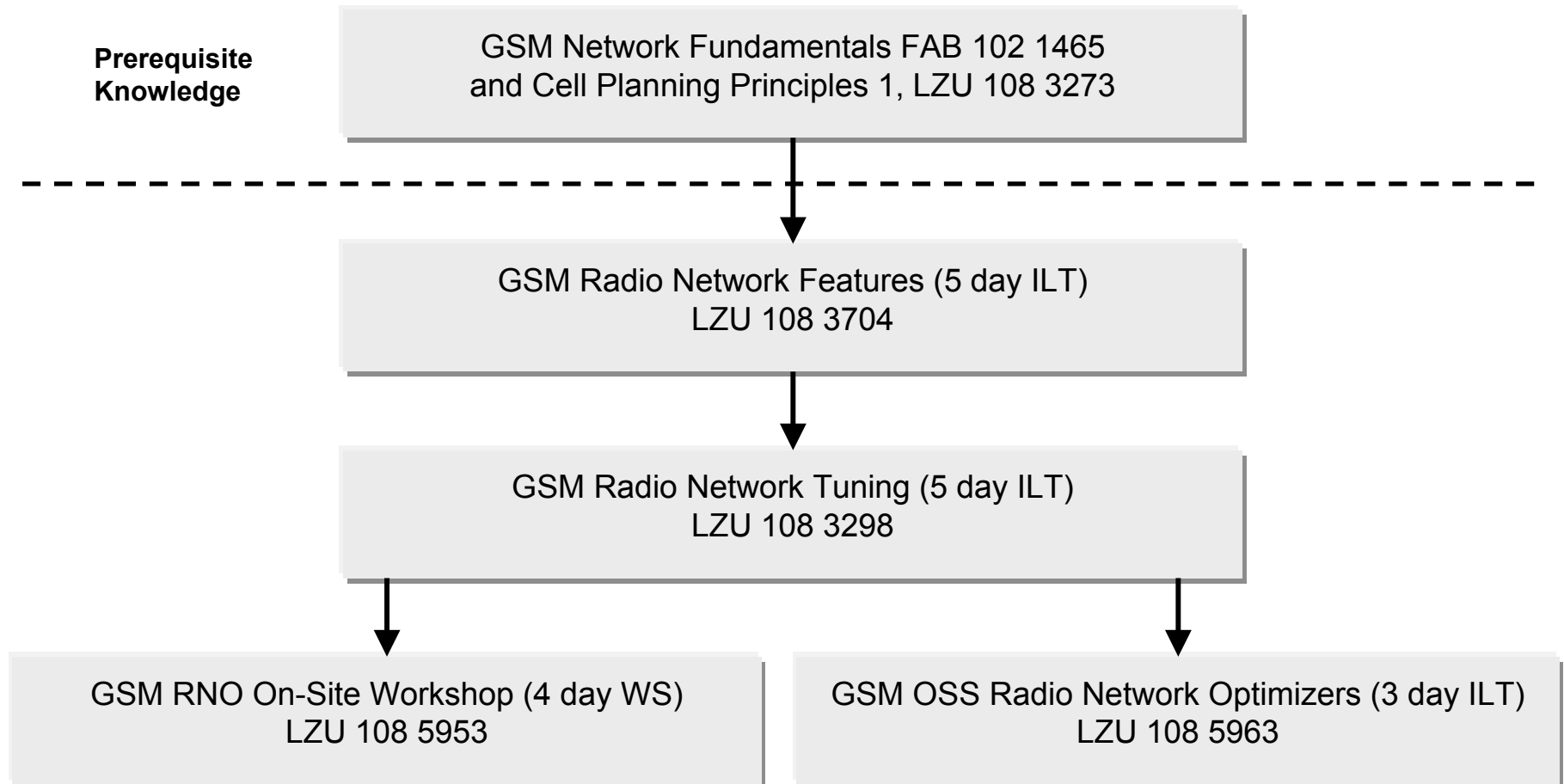

GPRS/EDGE Network Performance (FAB 102 xxxx)

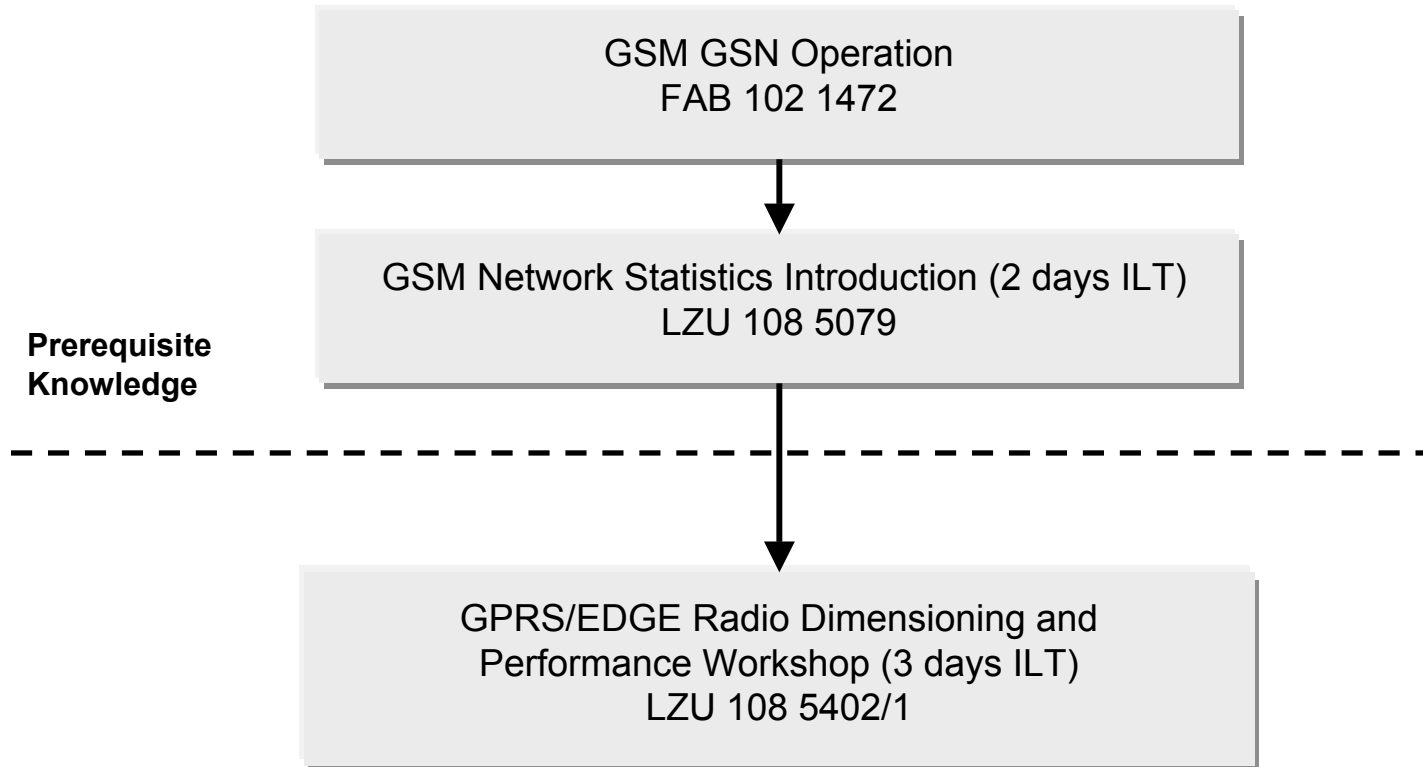

GPRS/EDGE Signaling (FAB 102 xxxx)

Prerequisite Knowledge

GSM Network Fundamentals (FAB 102 1465)

GPRS/EDGE Signaling (3 days ILT)
LZU 108 5931

GSM Network Management

- Operation -

OSS RC Introduction (FAB 102 1379)

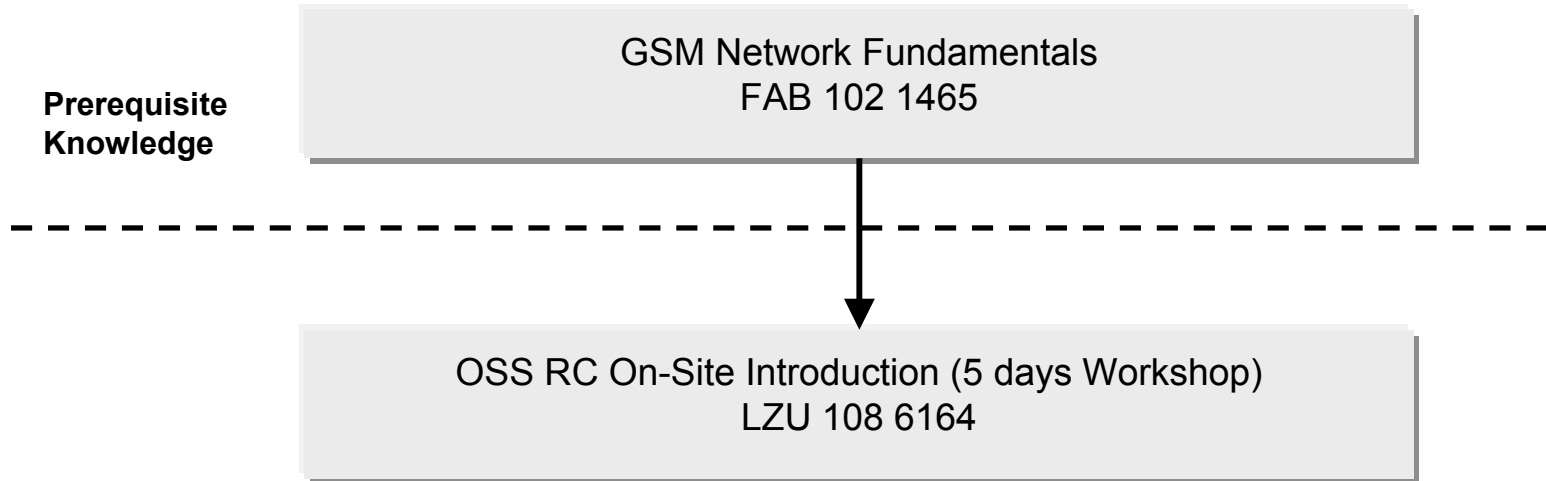

GSM Network Management

- System Administration -

OSS RC System Administration, (FAB 102 1481)

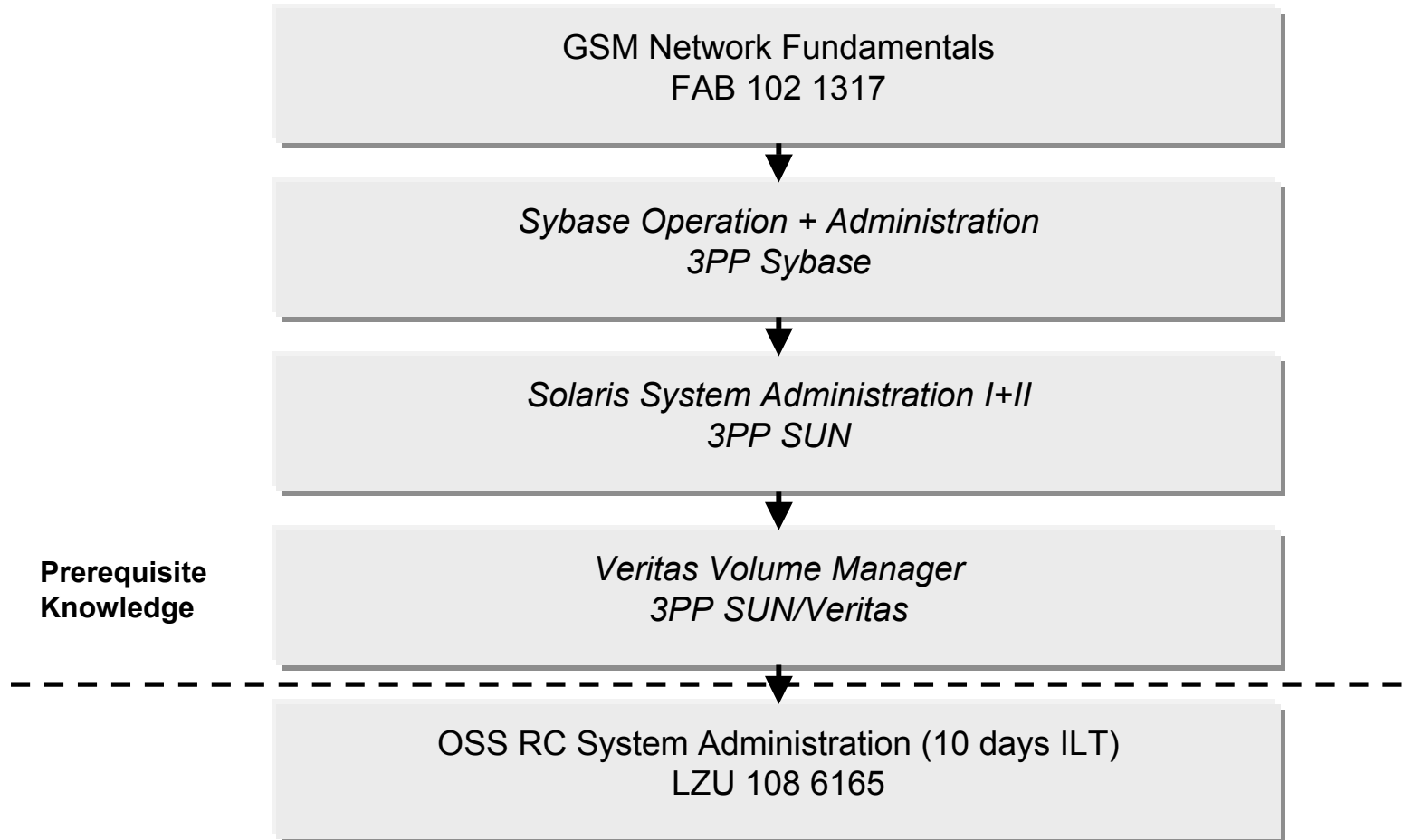

Location Based Services (FAB 102 1484)

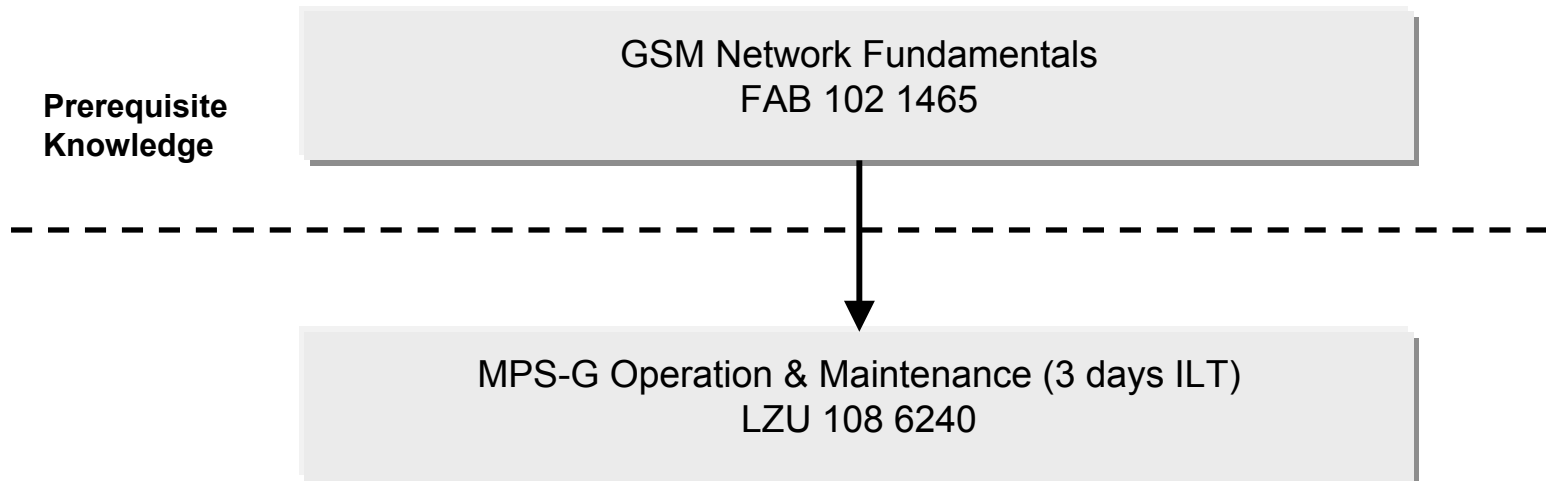

How do we deliver?

- ILT courses, delivered at Ericsson training centres or at customers site.
- e-learning products delivered by either Internet solution or Education Online portal on the extranet towards external customers.



Why Ericsson Education?

Global strength local expertise

- One of the worlds largest competence solutions suppliers

Broad Global Service Product Portfolio

Blended learning solutions

- Instructor Led Training (ILT)
- On-the-job programs
- Web based learning (WBL)
- Streaming Videos (SV)
- Seminars
- Multi-media based learning (MBL)
- Virtual Classroom/ Remote Training
- Online Articles
- On the Job Training
- Workshop



Cover all competence areas

- Technical/Professional, Business and Human skills

Summary

Be empowered

Ericsson Education is your competence partner. Linking human performance to business outcomes will give you the power to succeed. Our solutions combine global strength with local expertise - increase your performance anytime, anywhere.

With us, you will be first choice.

