

# OSS-RC 5 Training Programs



# Why invest in the OSS-RC 5 Package?

- Better controlling and optimizing the network performance
- Optimal investment
- Efficiently building and maintaining competence over system releases
- Comprehensive Competence
- Best fit in Learning Method

# What's in the OSS-RC 5 Package?

## Target Audiences

### **Delta Training**

OSS-RC 5 Delta Training  
OSS-RC 5 New Feature Workshops Core Network  
OSS-RC 5 New Feature Workshops WCDMA RAN  
OSS-RC 5 New Feature Workshops GSM RAN

### **Fundamentals**

GSM Network Fundamentals  
GSM Network Fundamentals, WBL  
WCDMA Network Fundamentals  
WCDMA Network Fundamentals, WBL

### **Network Operation**

OSS-RC 5 Introduction  
GSM RAN Network Surveillance  
GSM BSC Operation & Configuration  
GSM RAN BSS 06  
AXE Operation with OSS-RC 5  
WCDMA RAN Network Surveillance  
WCDMA Radio Access Network Operation  
WCDMA RAN Configuration with OSS-RC 5  
Core Network Operation with OSS-RC 5  
OSS-RC 5 New Feature Workshops Core Network  
Ericsson Network IQ Operation

### **IS/IT Support**

GSM OSS-RC 5 System Administration  
WCDMA OSS-RC 5 System Administration  
Core Network OSS-RC 5 System Administration  
Ericsson Network IQ Administration

### **Network Development**

GSM Radio Network Statistics  
GSM Radio Network Optimization  
GSM/WCDMA Optimization  
WCDMA RAN Performance Management  
WCDMA RAN Tuning and Optimization

# Supported Service Delivery Methods

## Icon

## Delivery Method



Instructor Led Training (ILT)



Seminar (SEM)



Workshop (WS)



Virtual Classroom Training (VCT)



Web Based Learning (WBL)



Short Article (SA)



Streaming Video (SV)



CD-ROM (CD)

# OSS-RC 5

- DELTA TRAINING -

# OSS-RC 5 Delta Training

(FAB 102 2014 R1A)

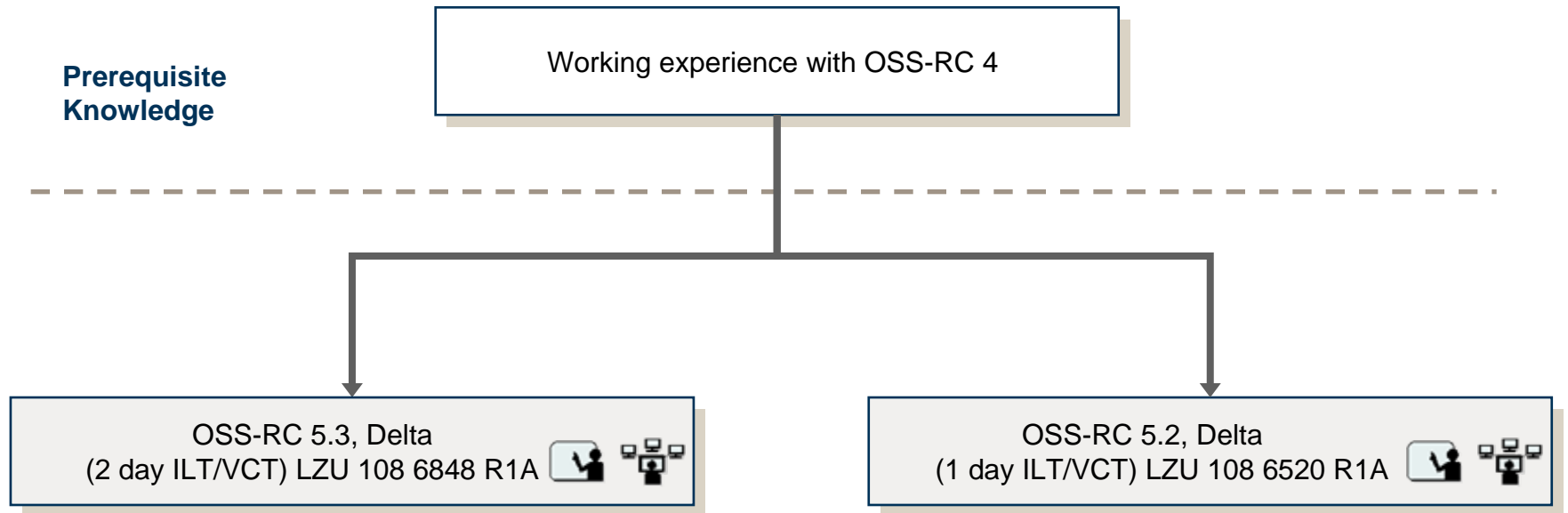

# OSS-RC 5 Event Based Statistics for SGSN

(FAB 102 2069 R1A)

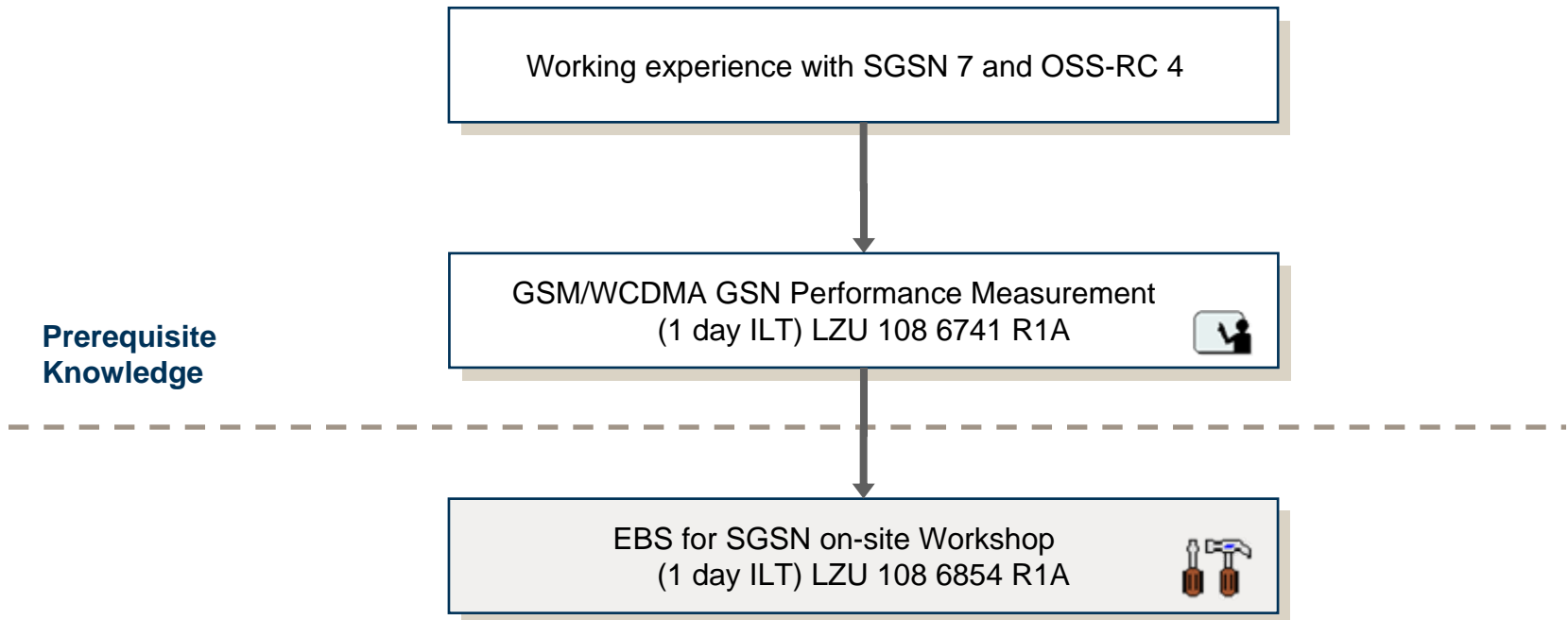

Note: This training will be available Q2 2008

# OSS-RC 5 New Feature Workshops WCDMA RAN

(FAB 102 2016 R1A)

**Prerequisite Knowledge**

Working experience with OSS-RC 4 and WCDMA RAN P5



OSS Navigator  
(X day ILT/VCT) LZU 108 xxxx R1A



WCDMA Transport Network  
System Techniques  
(1 day ILT/VCT) LZU 108 6921 R1A



Note: OSS  
Navigator training  
under investigation

# GSM Network

- Fundamentals -

# GSM Network Fundamentals, Blended Training (FAB 102 1465 R2A)

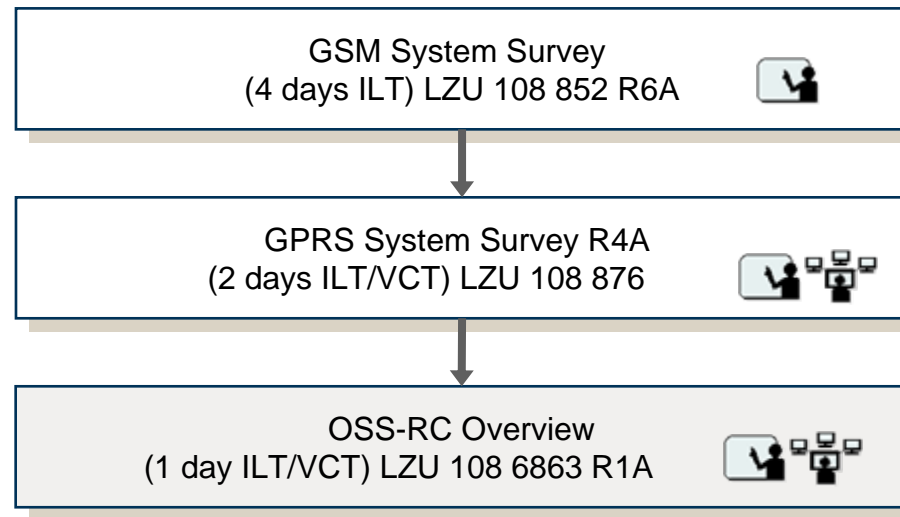

# GSM Network Fundamentals, WBL (FAB 102 1947 R1A)

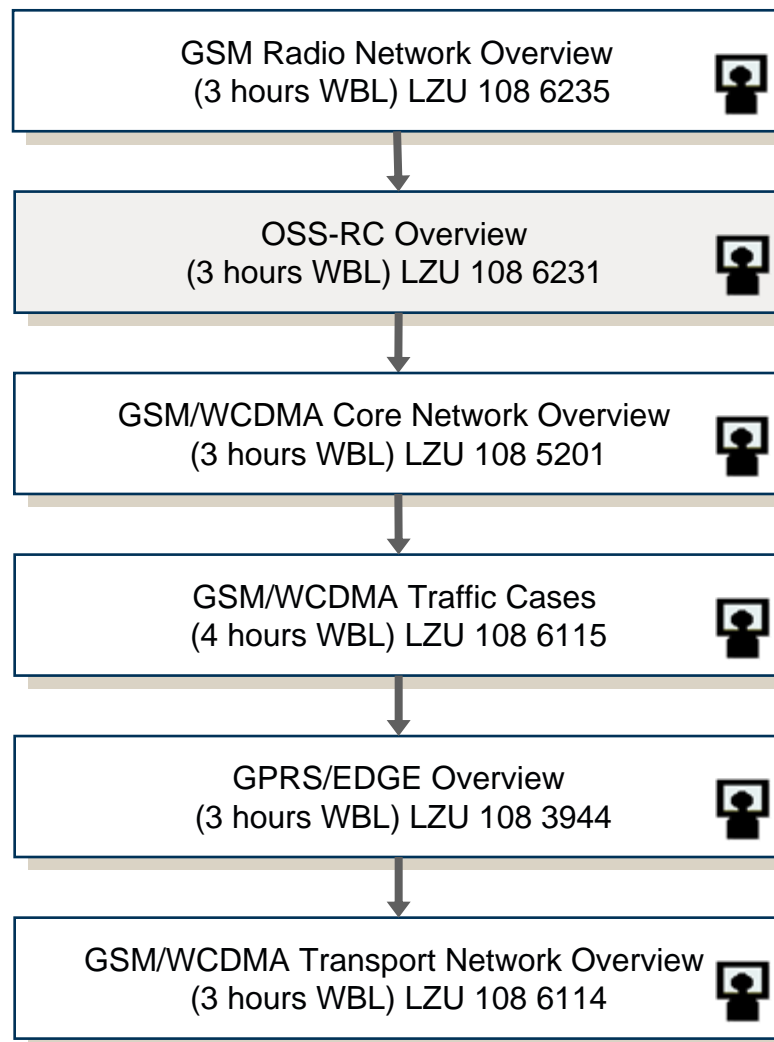

# WCDMA NETWORK

- FUNDAMENTALS -

# WCDMA Network Fundamentals, WBL

(FAB 102 1316 R1A)

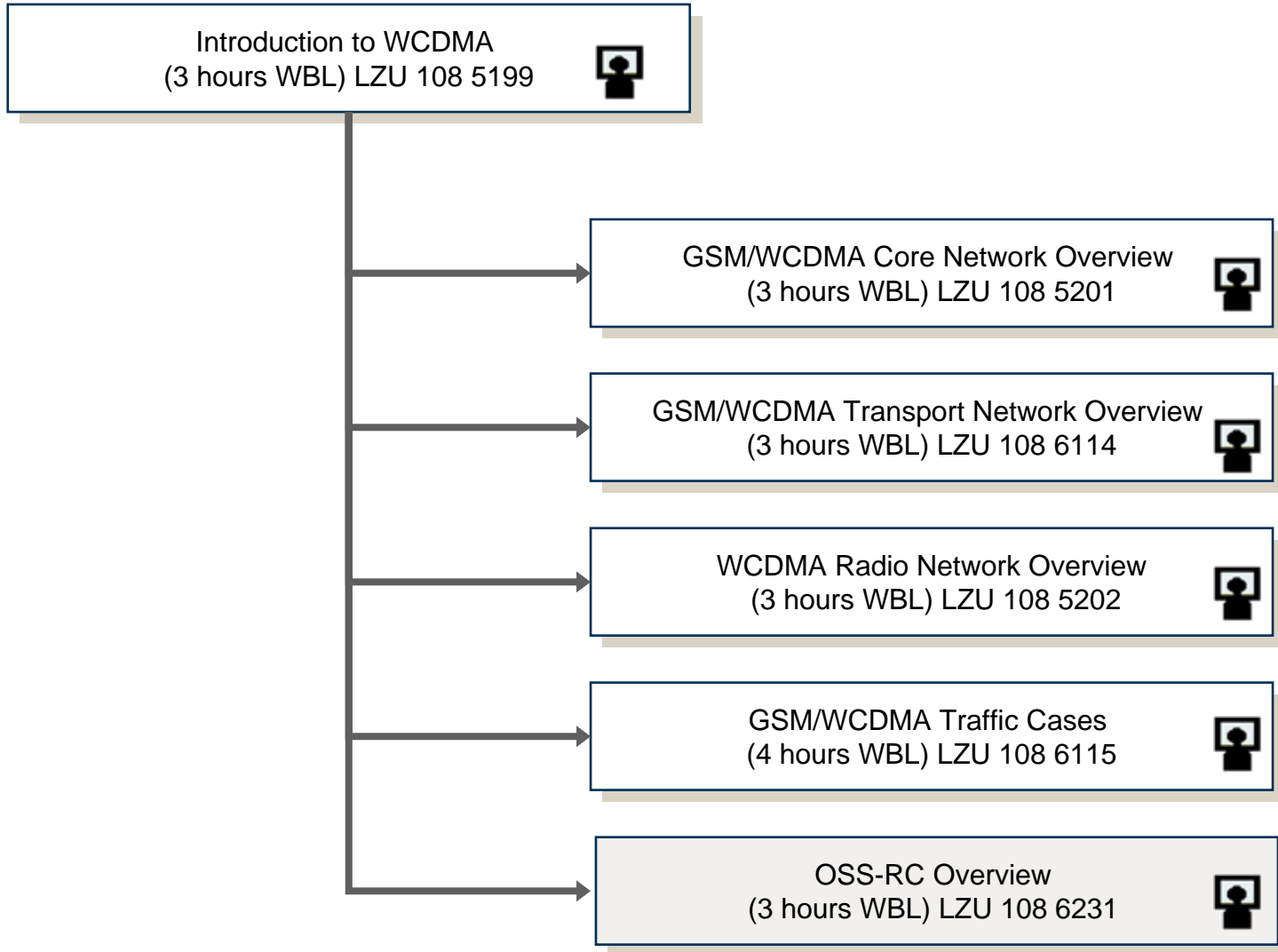

# WCDMA Network Fundamentals, Blended Training (FAB 102 1317 R2A)

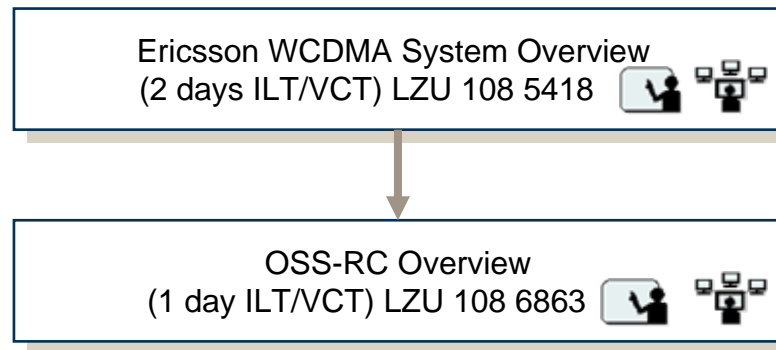

# GSM Radio Access Network

– Network Operation and Configuration -

# OSS-RC 5 Introduction

(FAB 102 1379 R1A)

**Prerequisite  
Knowledge**

GSM Network Fundamentals  
FAB 102 1465

OSS-RC 5 On-Site Introduction  
(5 days Workshop) LZU 108 6855 R1A 

# GSM RAN Network Surveillance

(FAB 102 1327 R1A)

## Prerequisite Knowledge

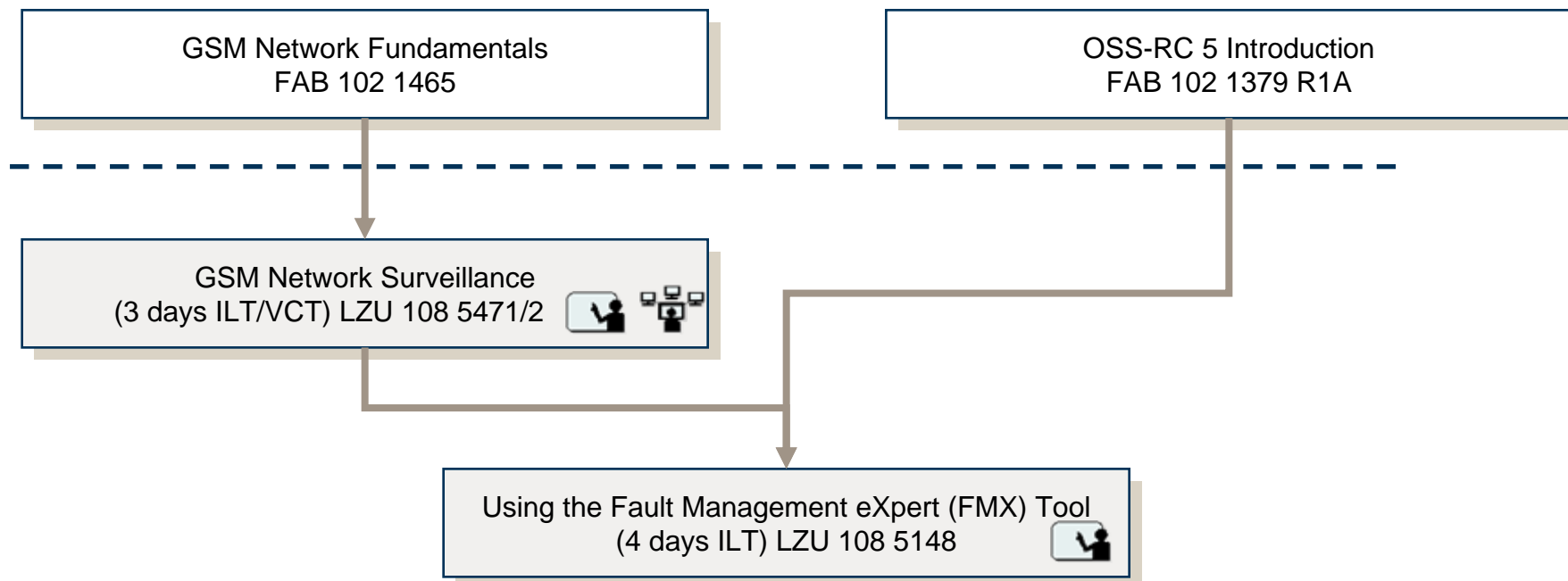

# GSM BSC Operation & Configuration

(FAB 102 1320 R2A)

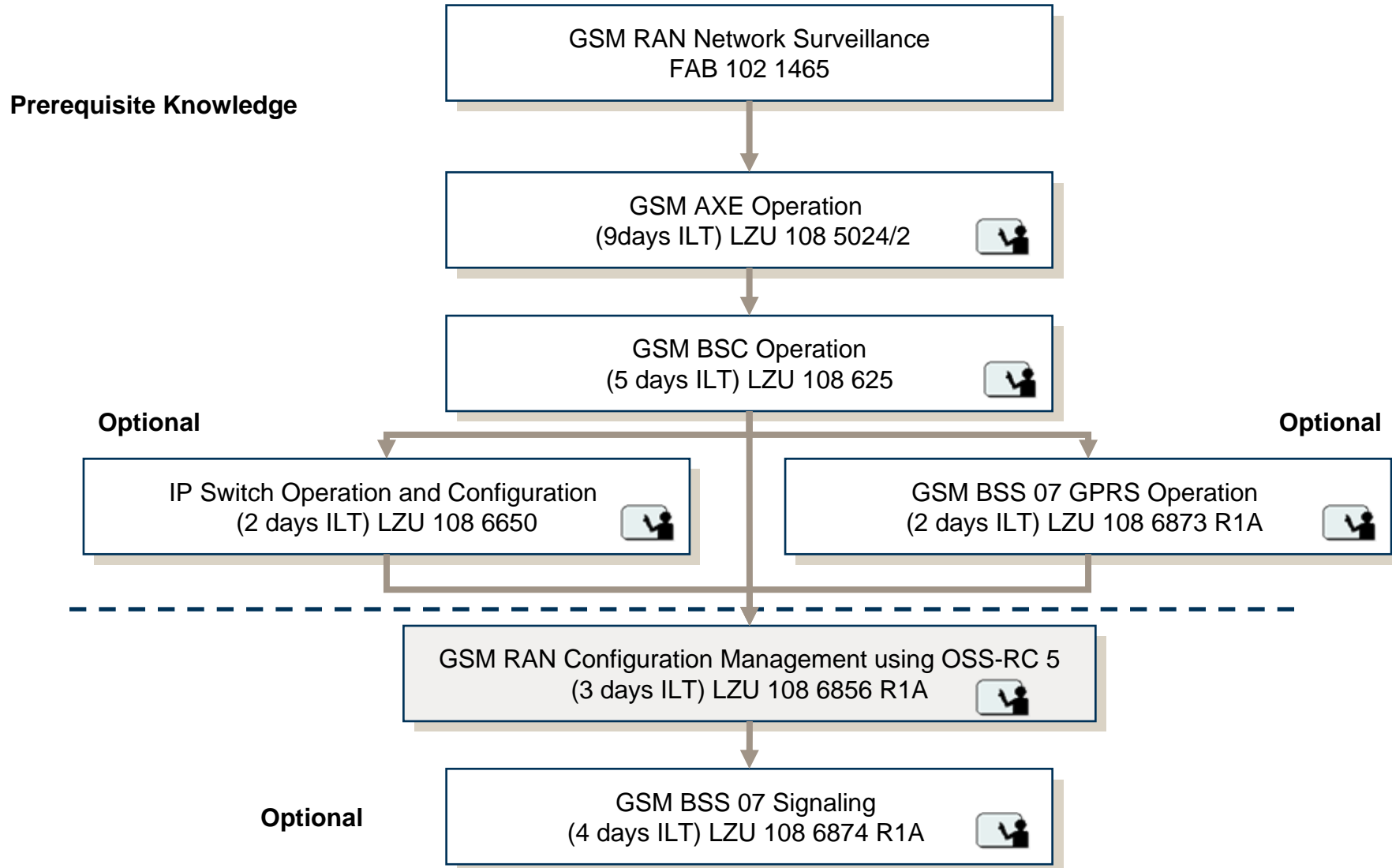

# GSM RAN BSS 06 Feature Training

(FAB 102 1937 R1A)

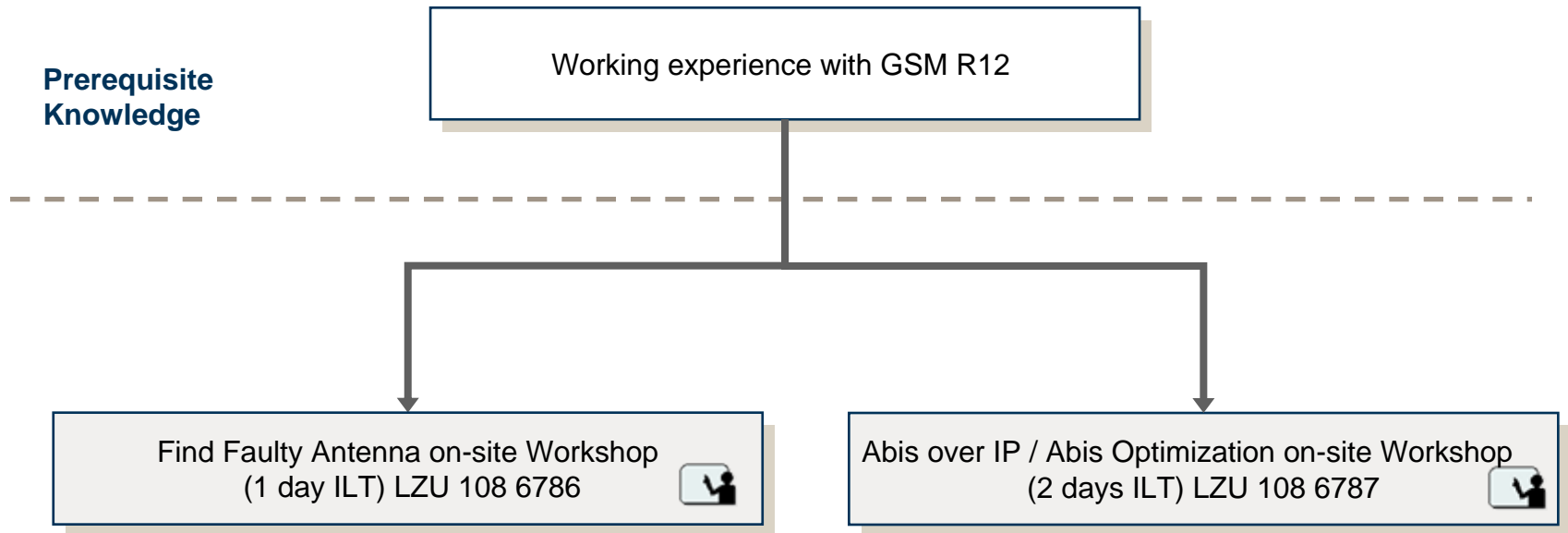

# AXE Operation with OSS-RC 5 (FAB 102 2068 R1A)

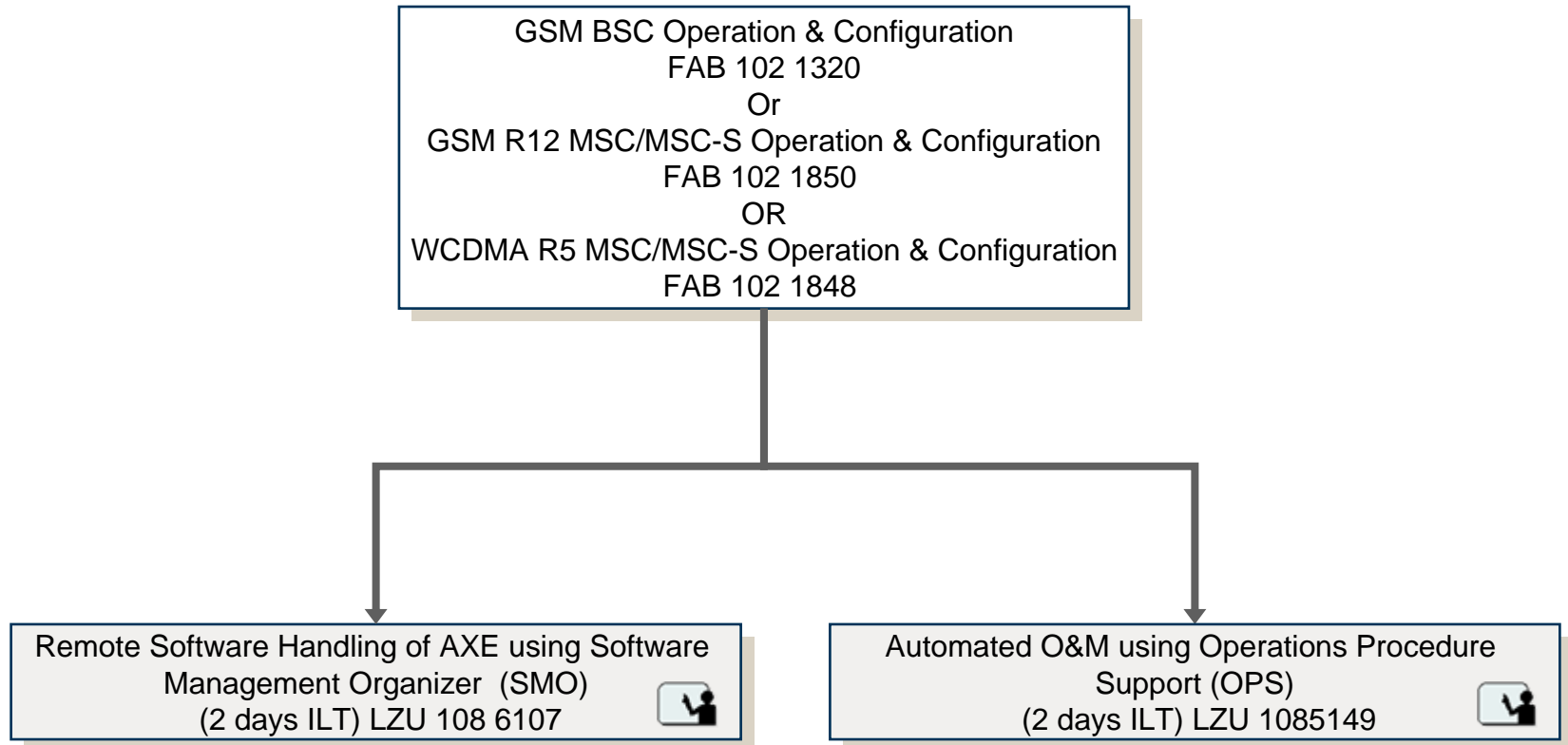

# GSM Radio Access Network

– Network Development -

# GSM Radio Network Statistics

(FAB 102 2044 R1A)

**Prerequisite  
Knowledge**

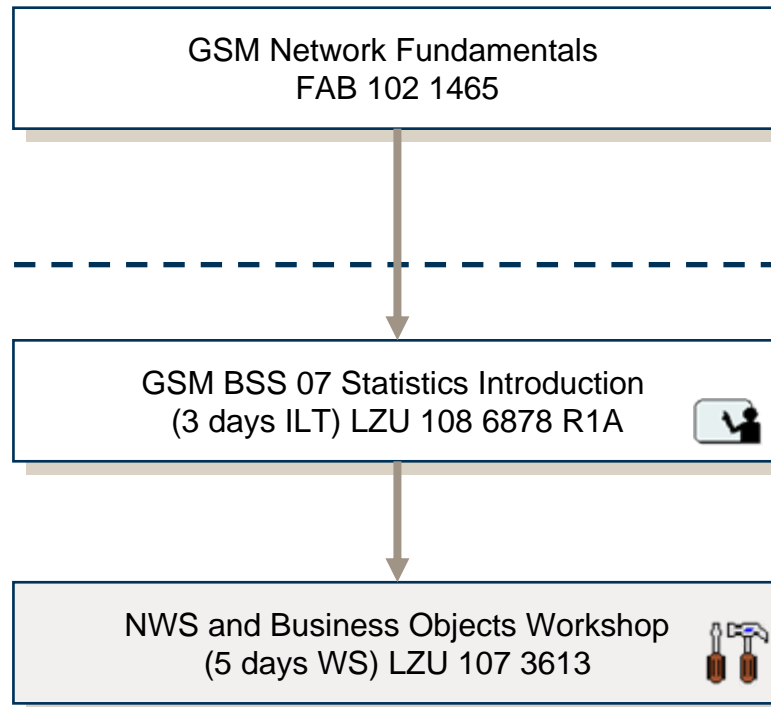

# GSM BSS 07 Radio Network Optimization

(FAB 102 2045 R1A)

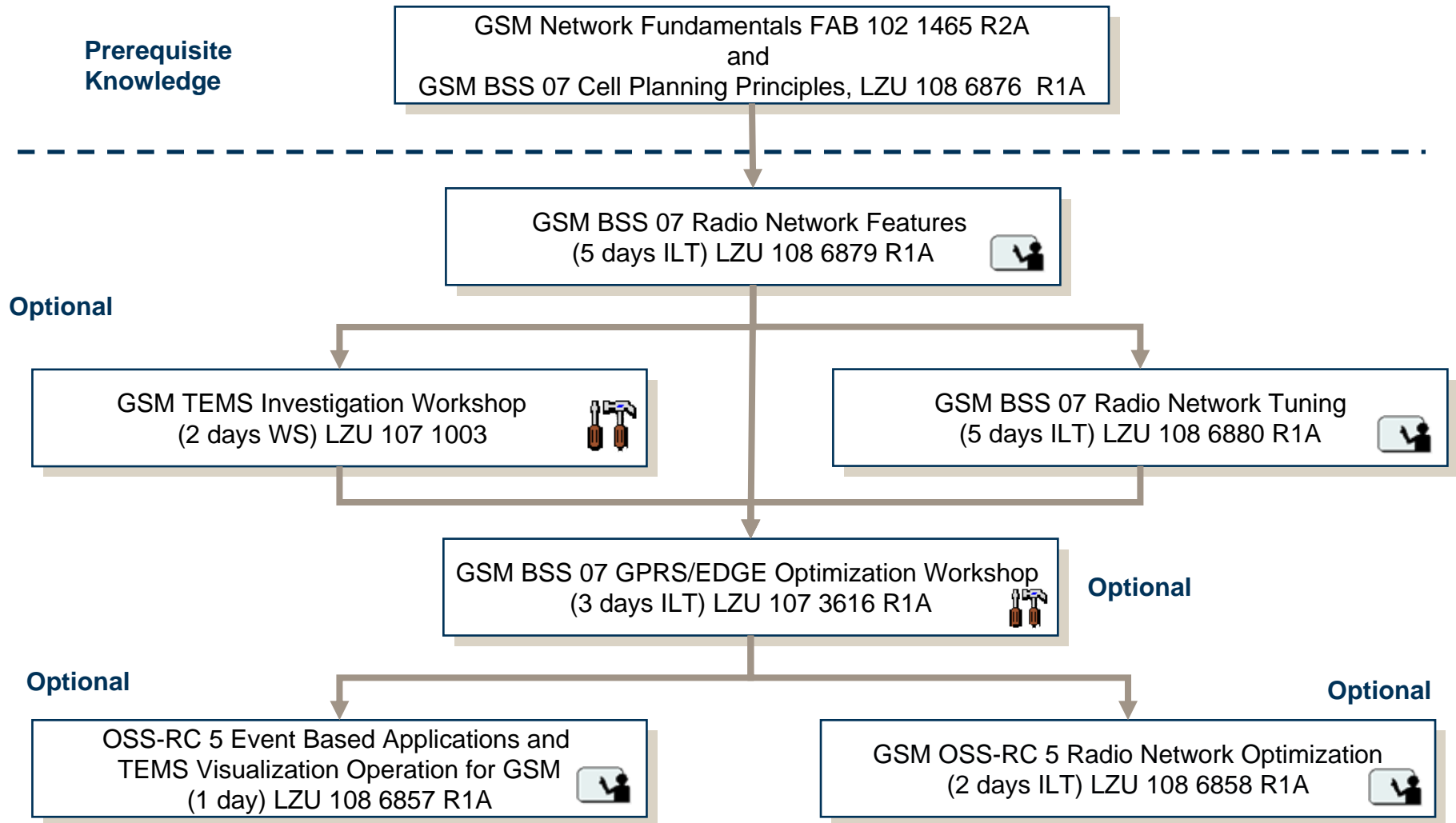

# GSM / WCDMA Optimization

## (FAB 102 1938 R2A)

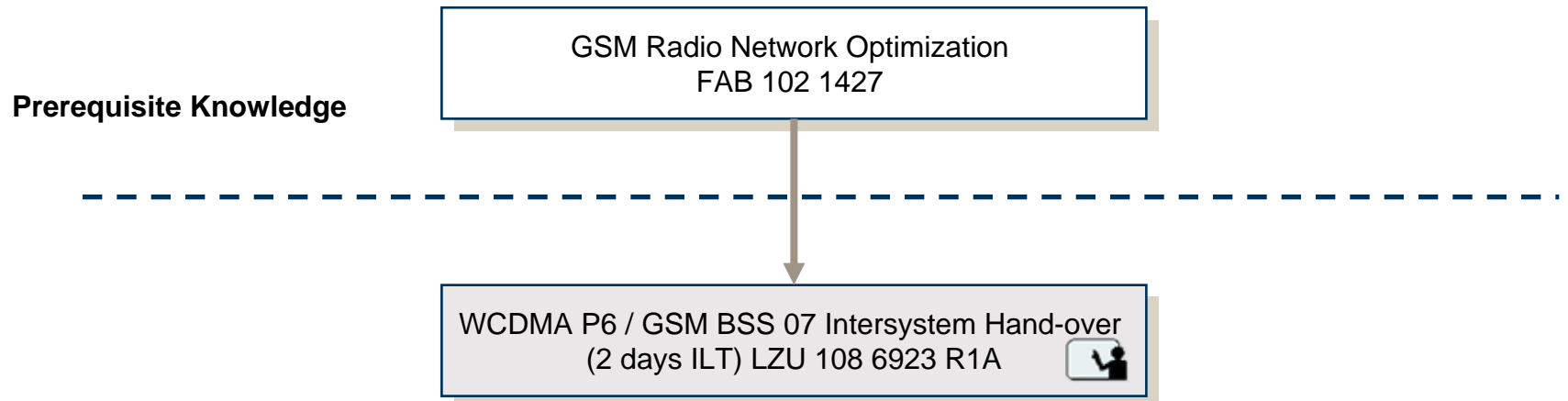

# GSM Radio Network Management

- System Administration -

# GSM OSS-RC 5 System Administration

(FAB 102 1481 R2A)

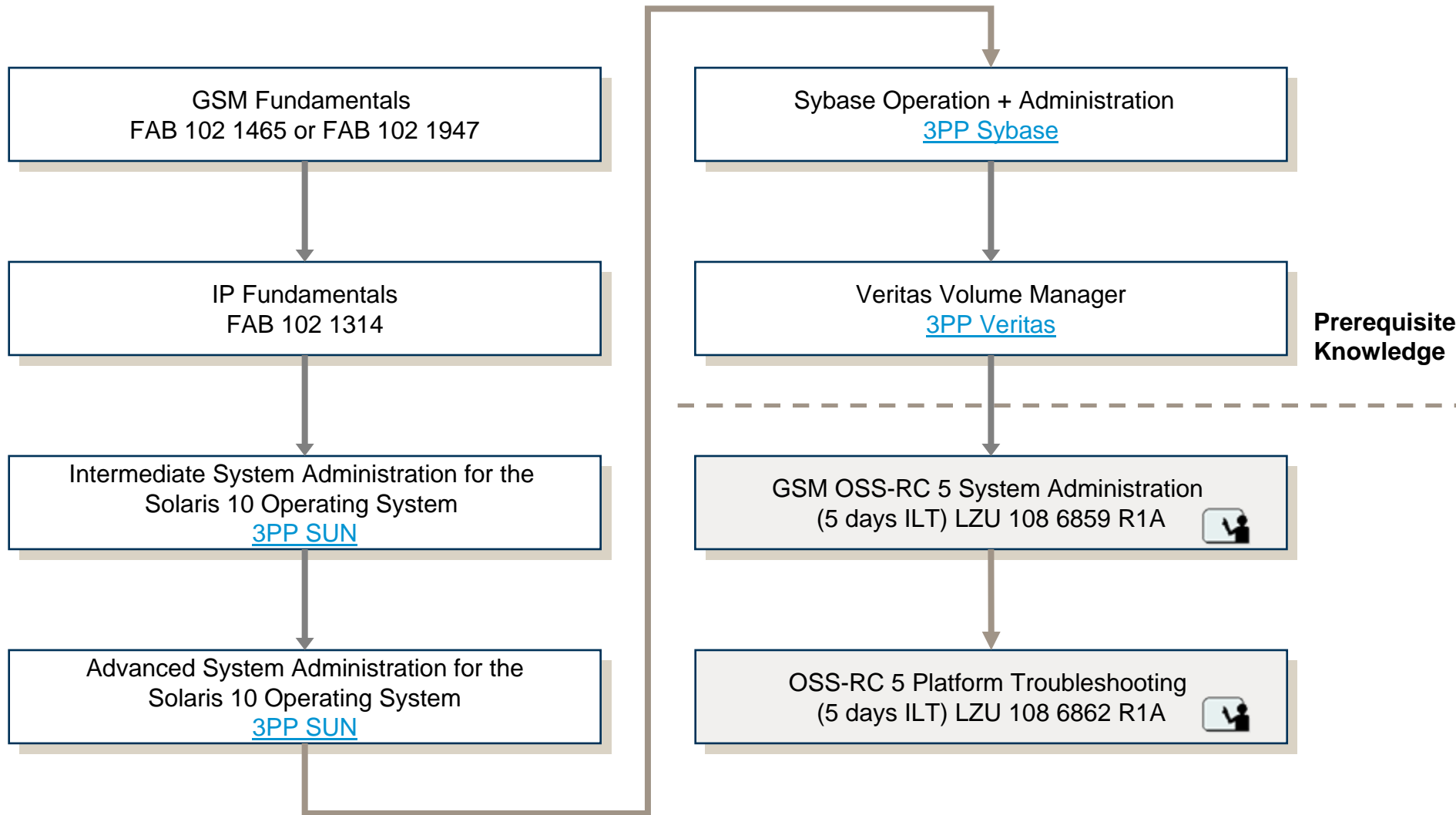

# WCDMA RADIO ACCESS NETWORK

- OPERATION & CONFIGURATION -

# WCDMA RAN Network Surveillance

(FAB 102 1666 R2A)

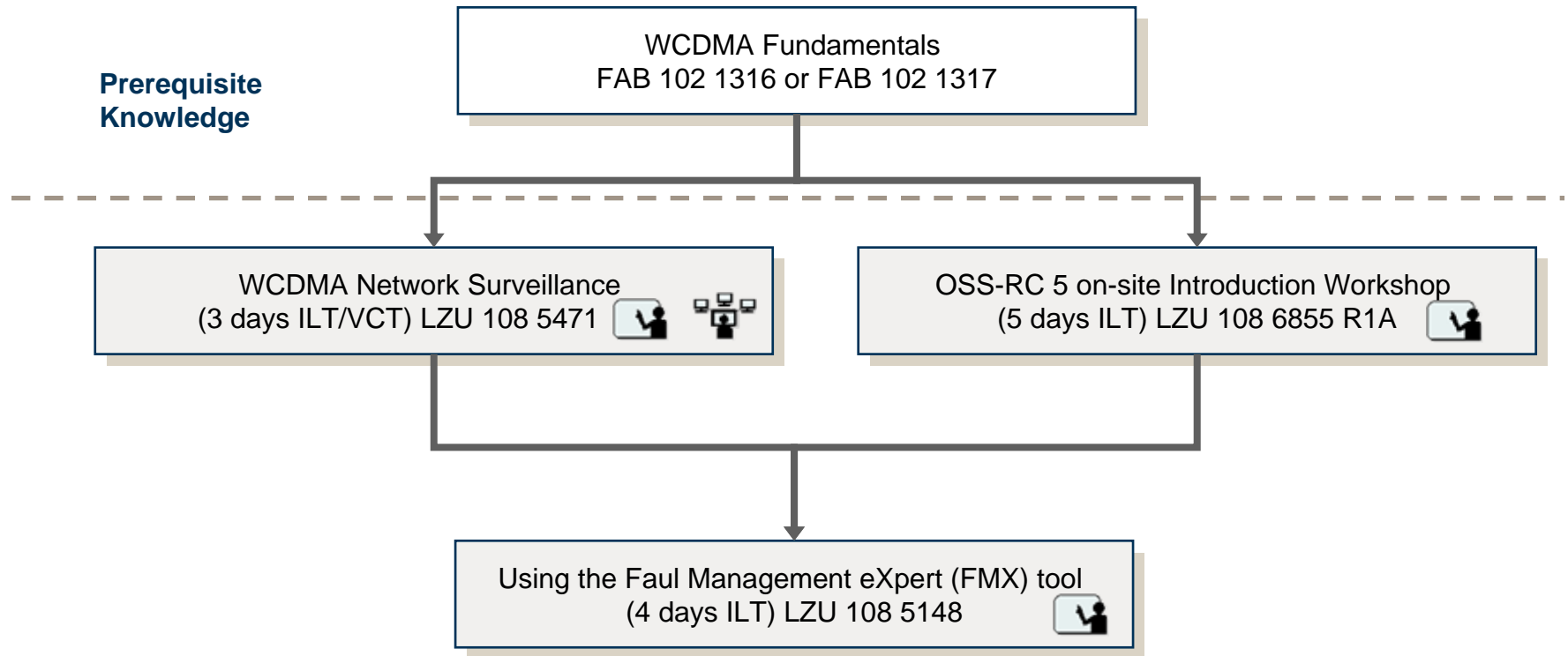

# WCDMA Radio Access Network Operation (FAB 102 1329 R1A)

Prerequisite  
Knowledge

---

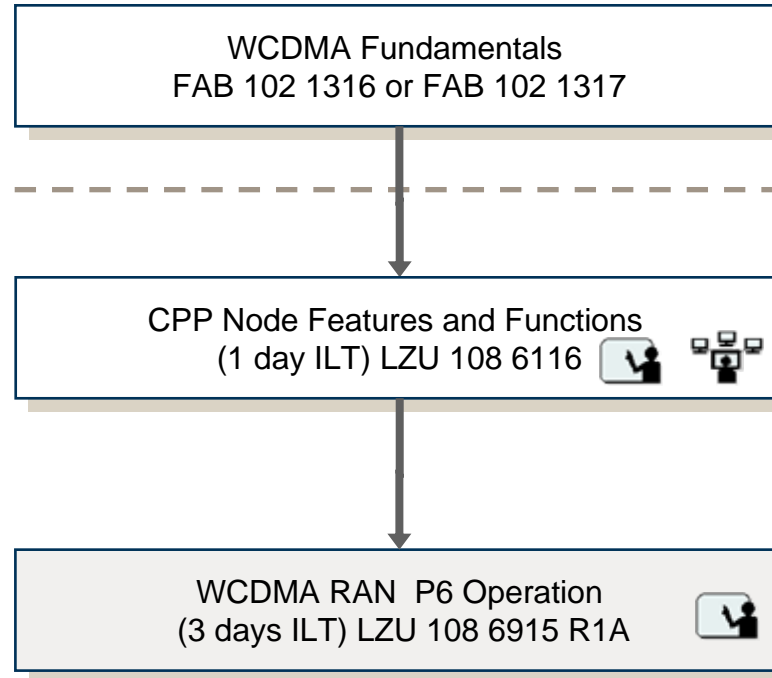

If the tasks for Network Operation and Configuration would be done within one and the same target group, the course **WCDMA RAN P6 Configuration, LZU 108 6918** can be taken right after the course WCDMA RAN P6 Operation.

# WCDMA RAN Network Configuration with OSS-RC 5 (FAB 102 2018 R1A)

**Prerequisite  
Knowledge**

WCDMA RAN P6 Configuration  
(5 days ILT) LZU 108 6918 R1A



WCDMA RAN Configuration and Optimization with OSS-RC 5  
(2 days ILT) LZU 108 6864 R1A



Note: This training will be available Q2 2008

Covered OSS Features:

WCDMA RAN Configuration Manager

Consistency Checker WCDMA

HSDPA Management

Enhanced Uplink Management

NOX-W

NCS-W

# WCDMA RADIO ACCESS NETWORK

– NETWORK DEVELOPMENT –

# WCDMA RAN P6 Performance Management

(FAB 102 2058 R1A)

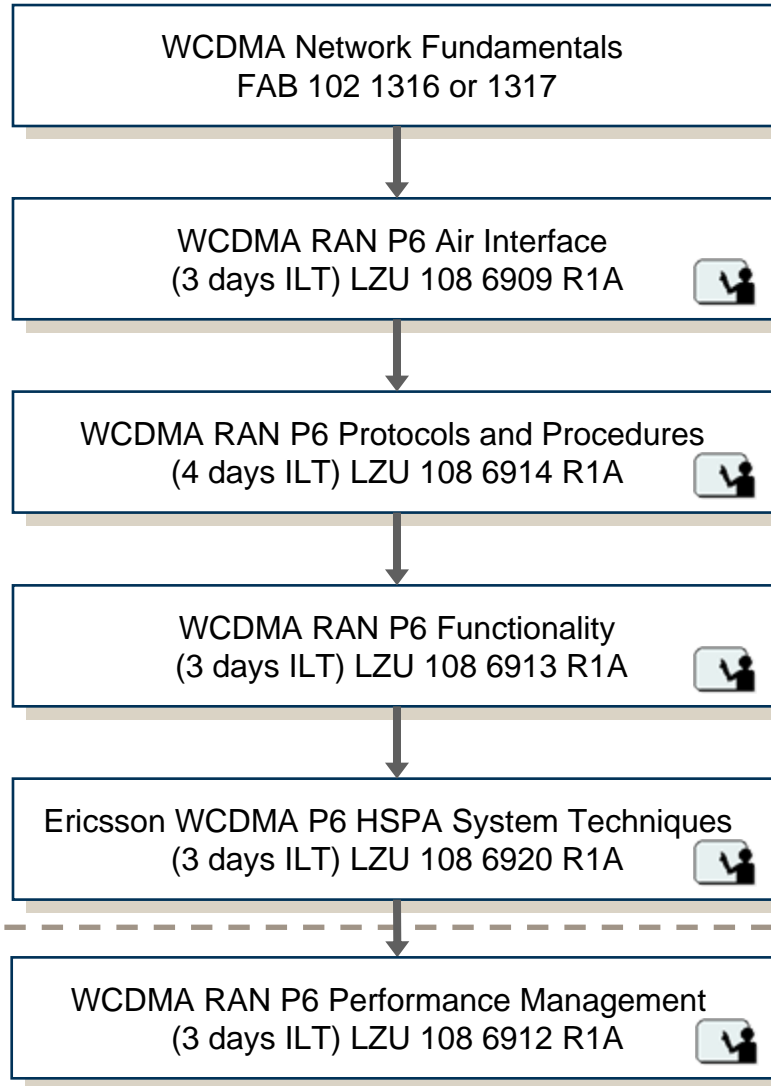

**Prerequisite  
Knowledge**

# WCDMA Radio Network P6 Tuning and Optimization

(FAB 102 2059 R1A)

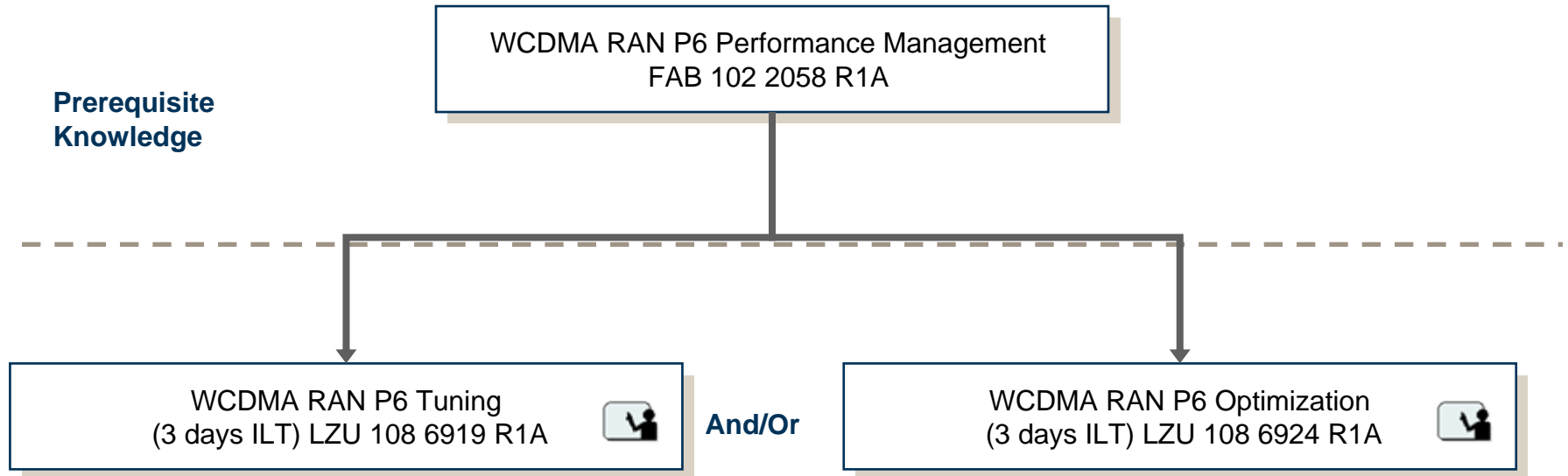

# WCDMA NETWORK MANAGEMENT

- SYSTEM ADMINISTRATION -

# WCDMA OSS-RC 5 System Administration (FAB 102 2066 R1A)

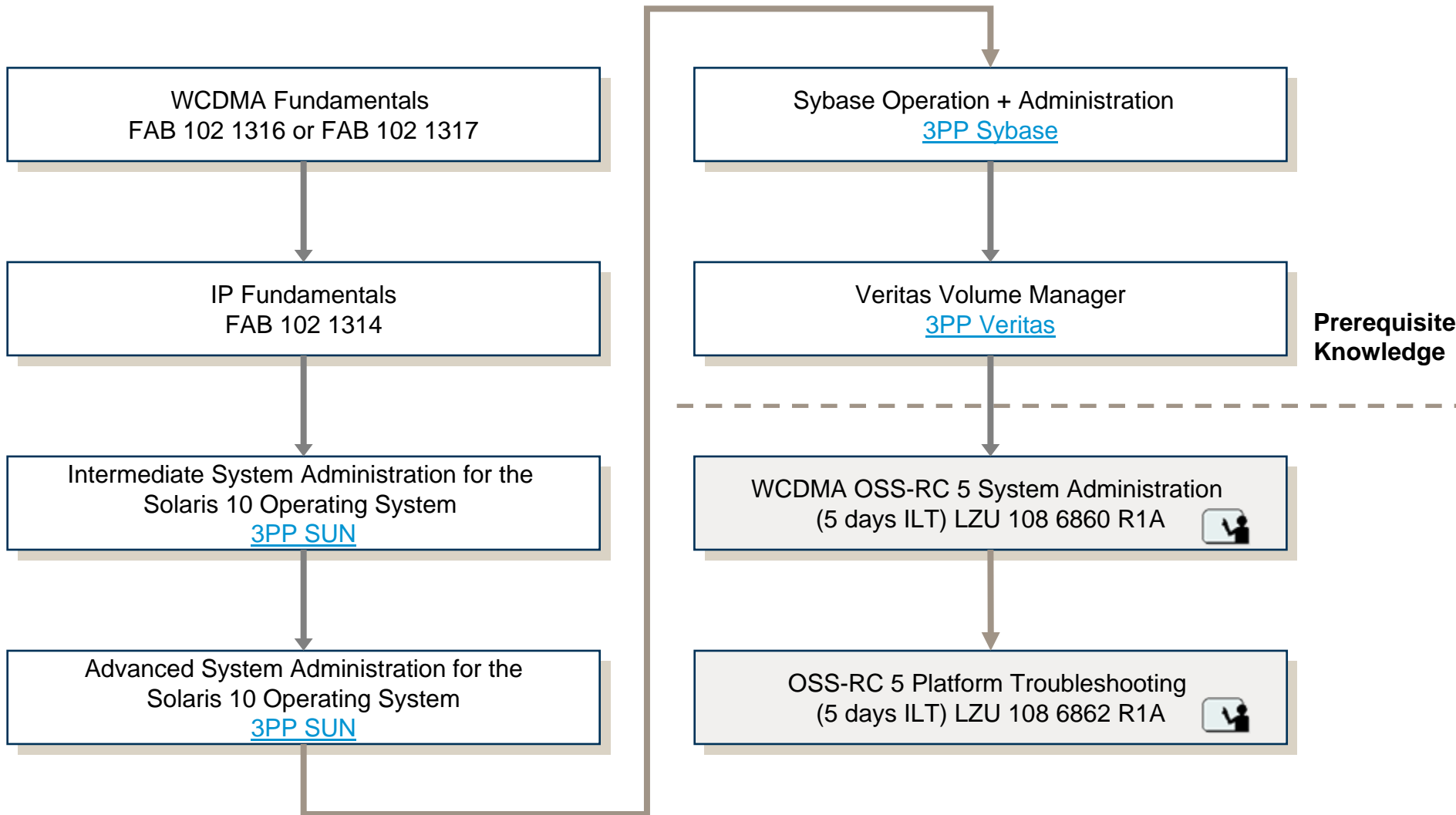

# Core Network

– Network Operation and Configuration -

# Core Network Operation with OSS-RC 5

(FAB 102 2019 R1A)

## Prerequisite Knowledge

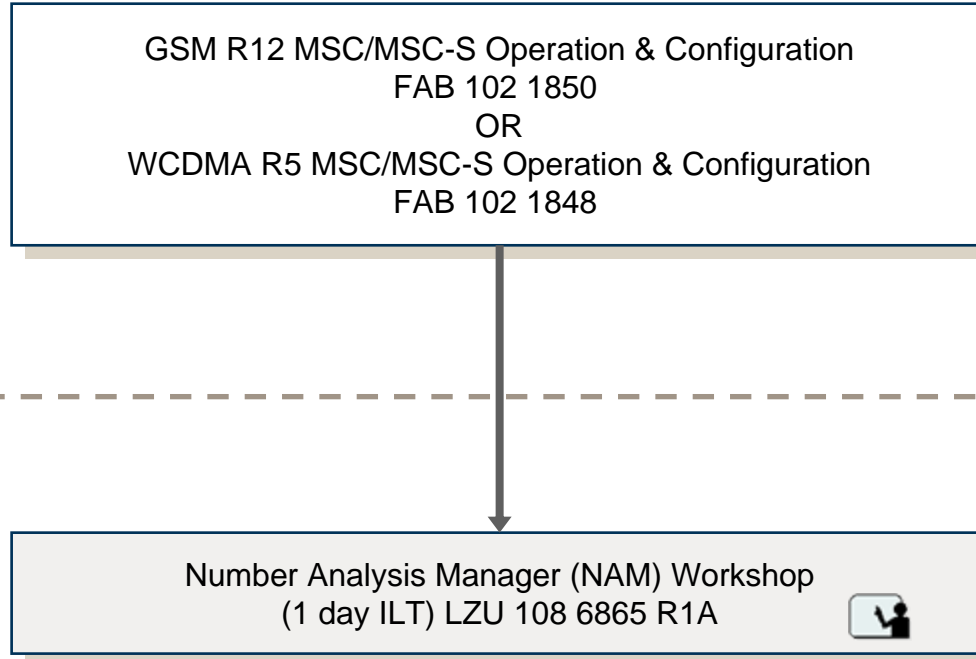

# Core Network Operation with OSS-RC 5

(FAB 102 2019 R1A)

**Prerequisite  
Knowledge**

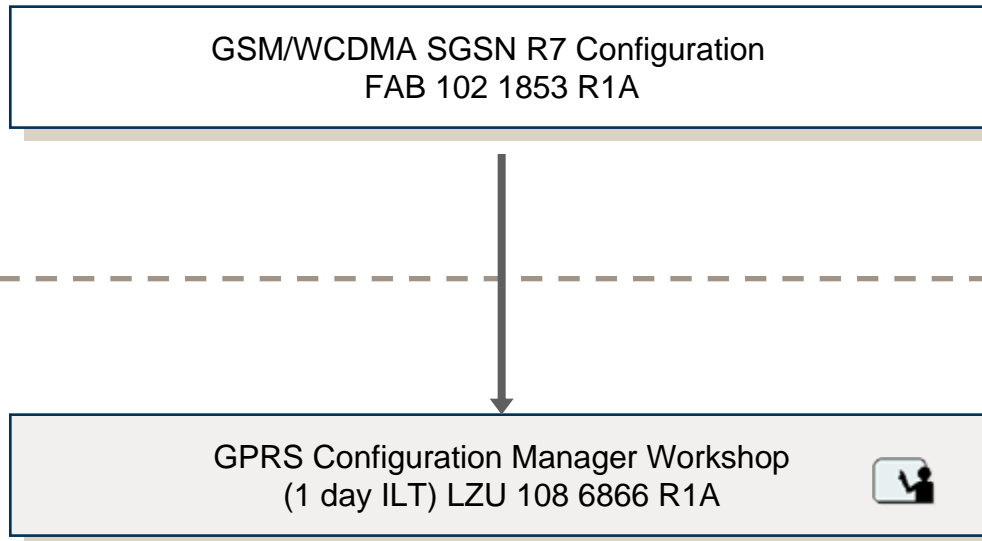

# OSS-RC 5 MSC in Pool Manager

(FAB 102 2015 R1A)

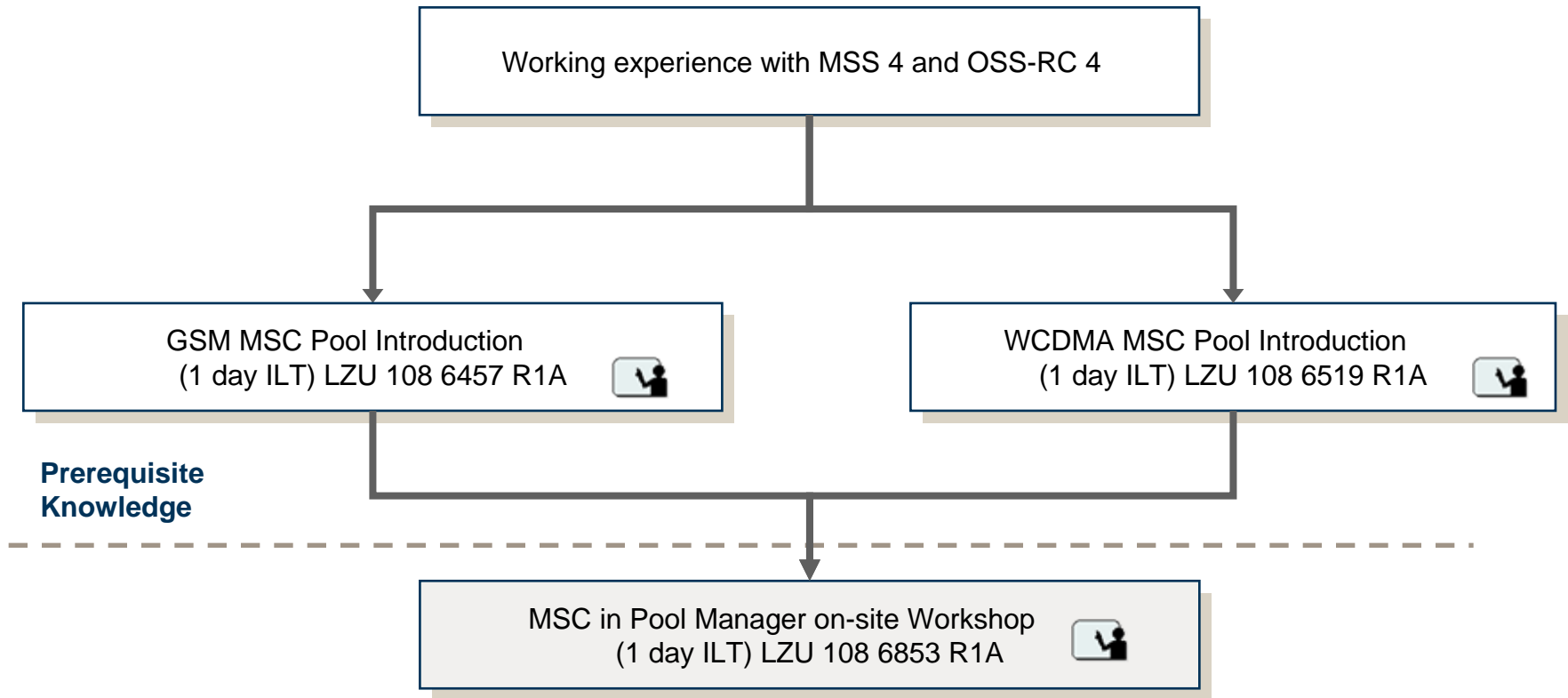

Note: This training will be available in OSS-RC 6

# OSS-RC 5 Event Based Statistics for SGSN (FAB 102 2069 R1A)

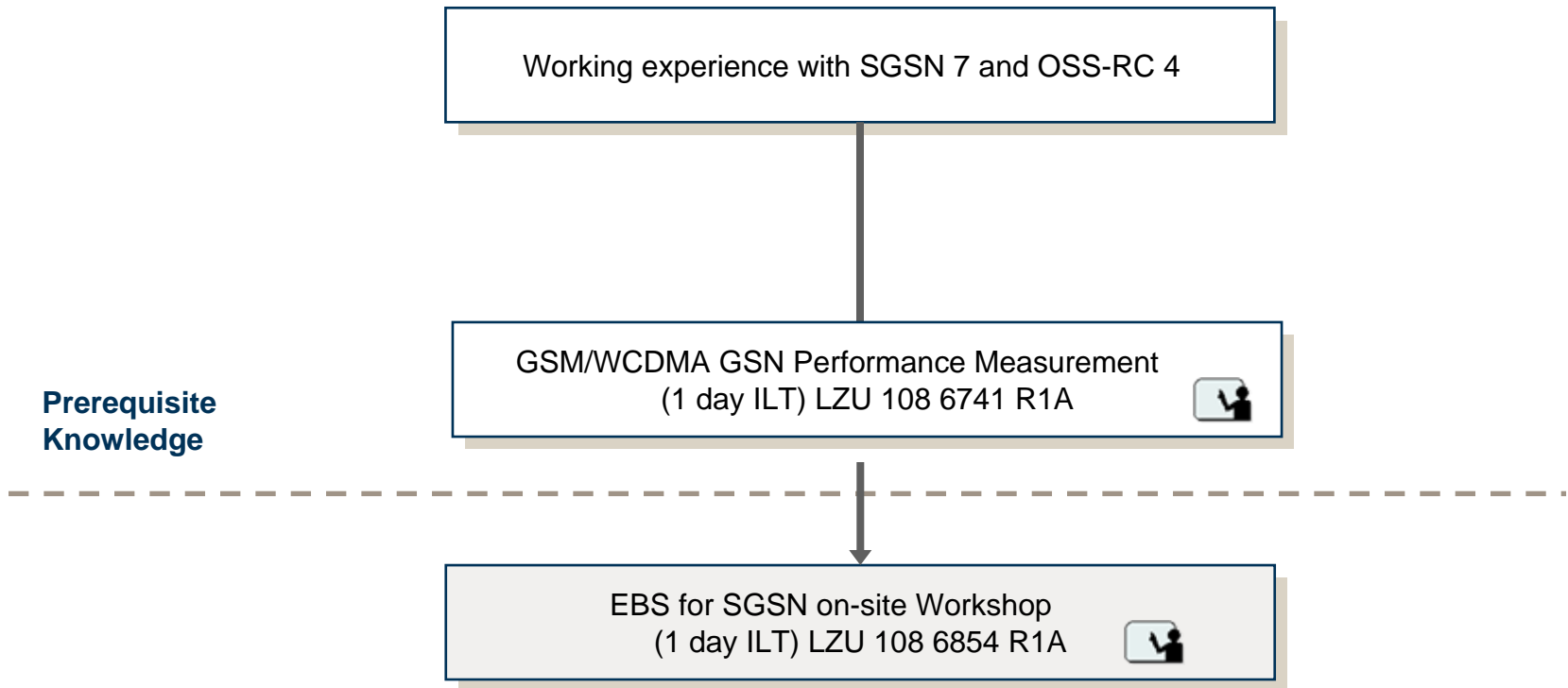

Note: This training will be available Q2 2008



# Multi-vendor

– NETWORK DEVELOPMENT –

# Ericsson Network IQ Operation

(FAB 102 2020 R1A)

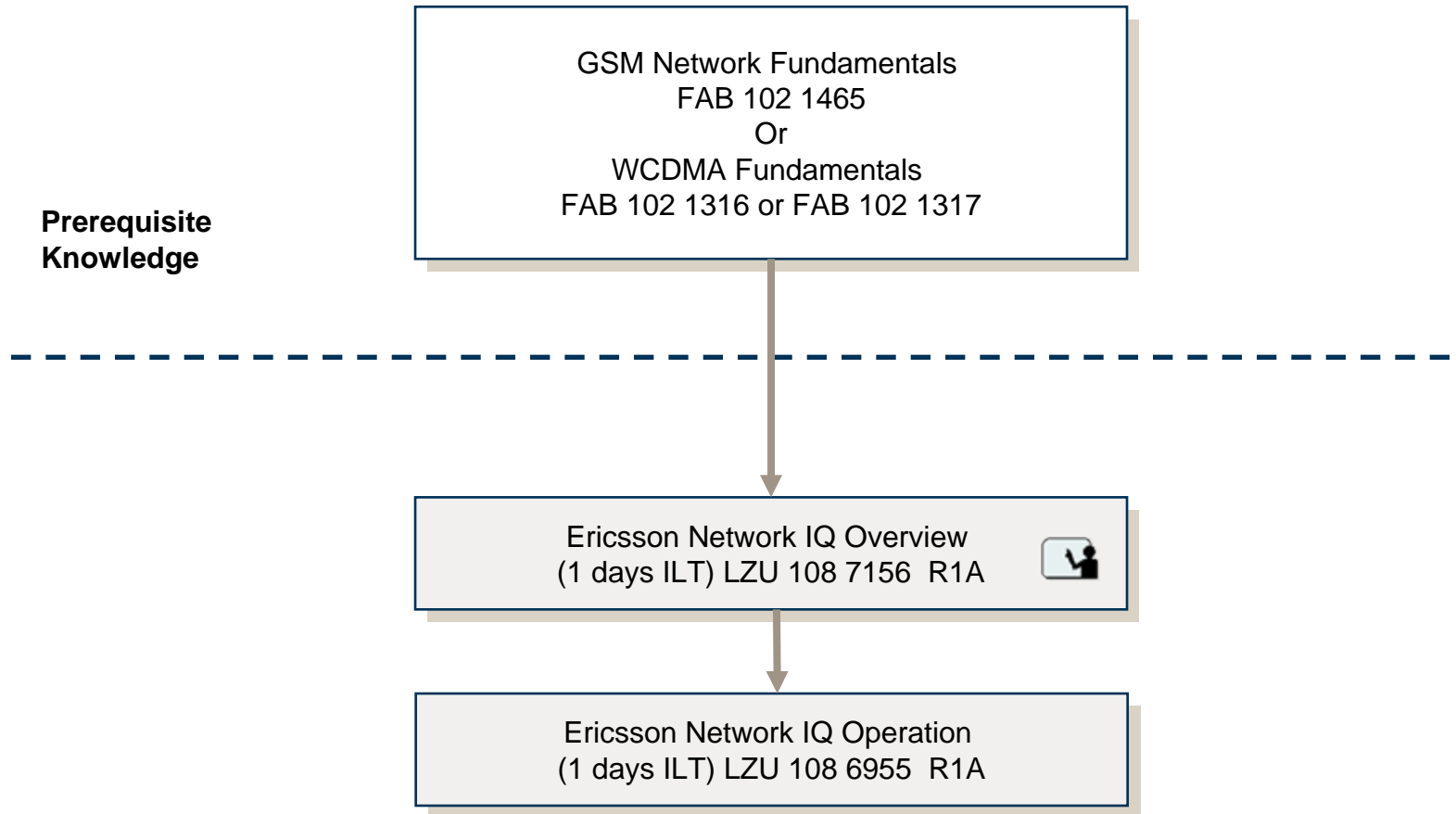

# Ericsson Network IQ Administration

## (FAB 102 2021 R1A)

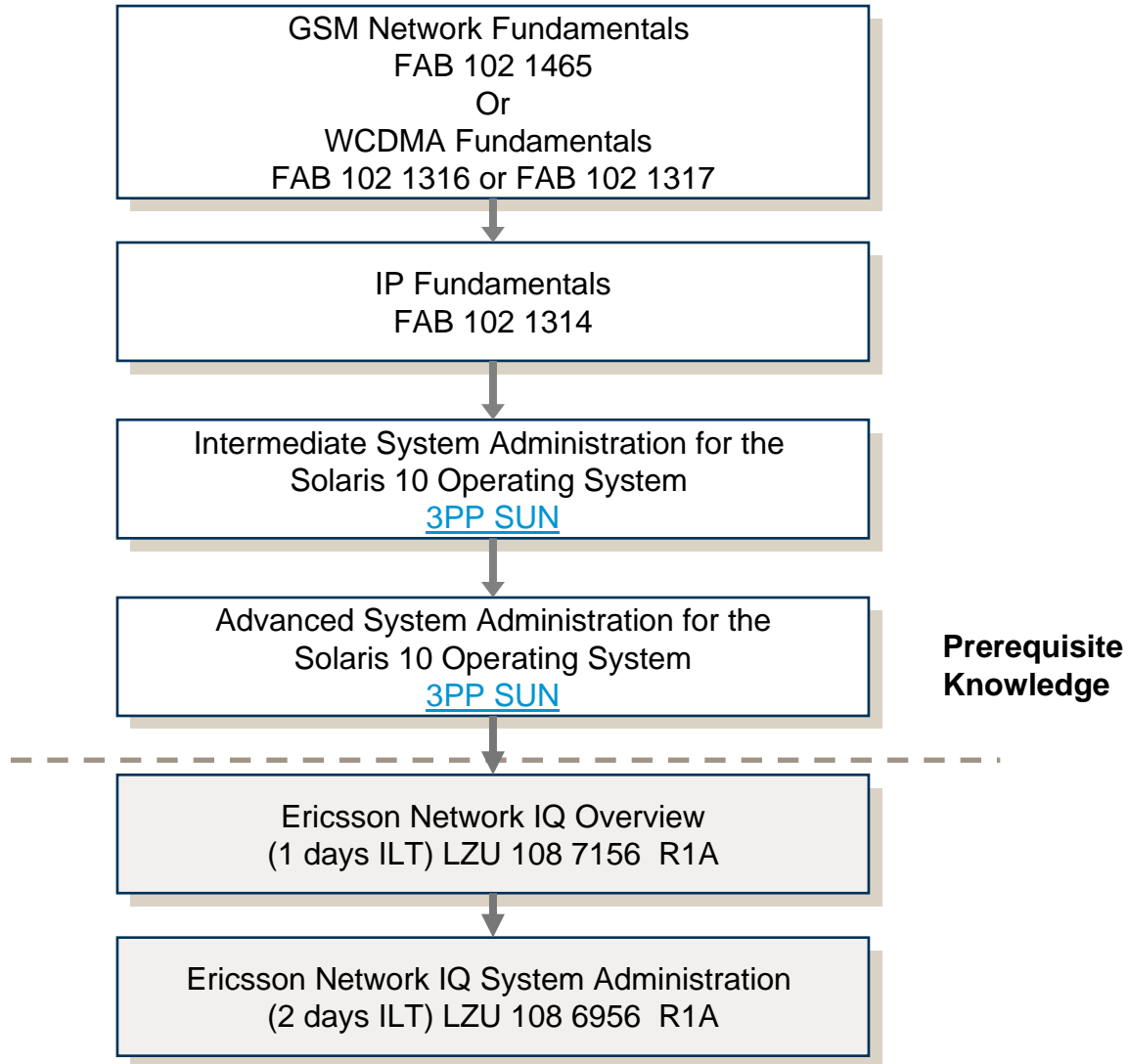

# Related Training Packages

The following related training packages can be found at

[http://www.ericsson.com/products/services/training/find\\_training.shtml](http://www.ericsson.com/products/services/training/find_training.shtml)

- WCDMA RAN
- GSM RAN
- Core Network

■ The following Education Services can be found at

[http://www.ericsson.com/products/services/training/learning\\_solutions.shtml](http://www.ericsson.com/products/services/training/learning_solutions.shtml)

- Learning Solutions
- Structured Knowledge Transfer (SKT)

**ERICSSON**



**TAKING YOU FORWARD**